

THREE LANE PAVEMENT PLAN
(3.6m AND 7.2m PLACEMENT)

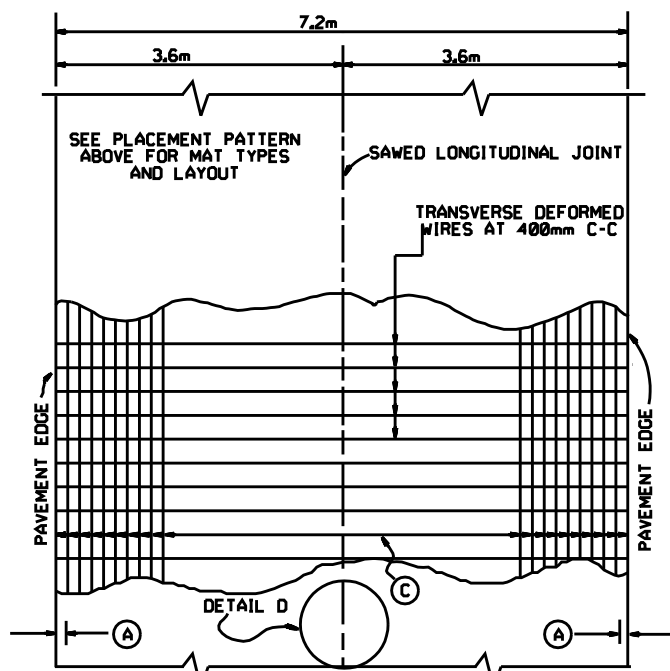

TWO LANE PAVEMENT PLAN
(7.2m PLACEMENT)

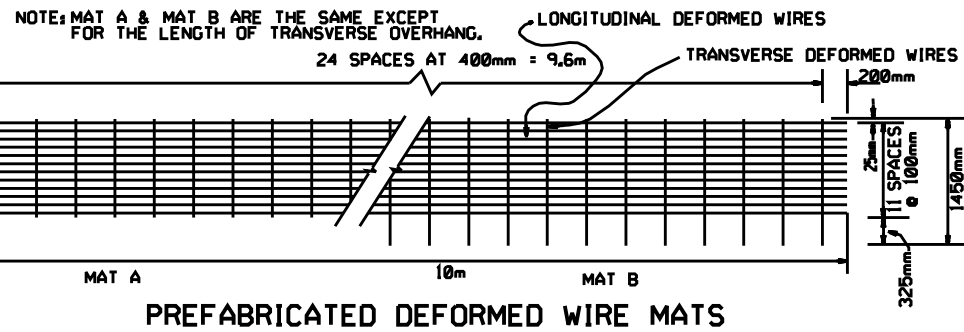

PREFABRICATED DEFORMED WIRE MATS

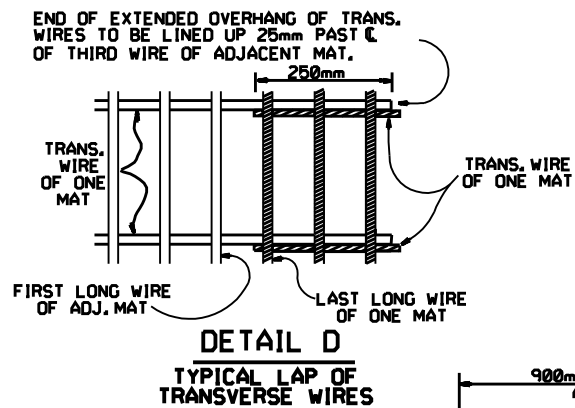

DETAIL D
TYPICAL LAP OF TRANSVERSE WIRES

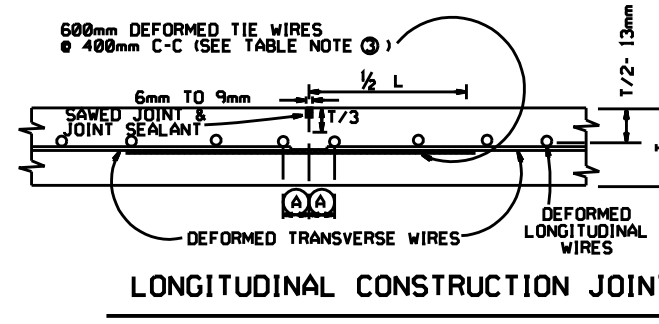

LONGITUDINAL CONSTRUCTION JOINT

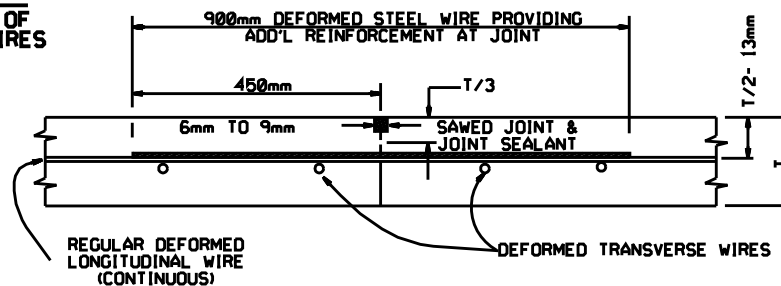

TRANSVERSE CONSTRUCTION JOINT

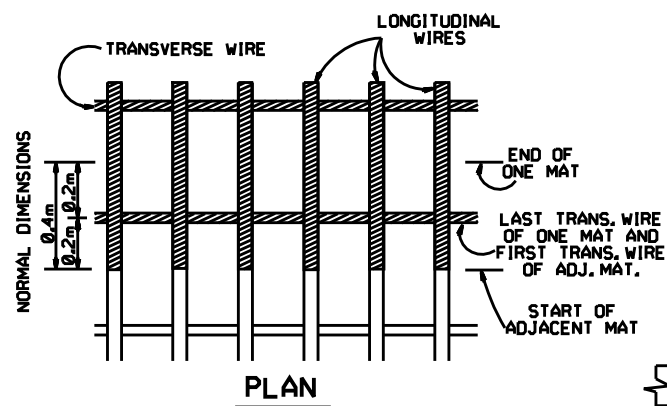

PLAN

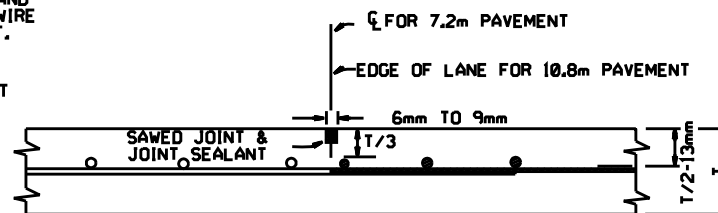

SAWED LONGITUDINAL JOINT

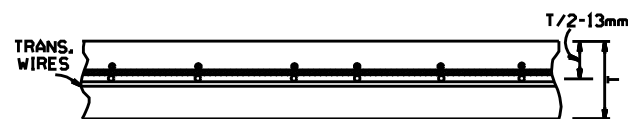

SECTION DETAIL E

TYPICAL LAP OF LONGITUDINAL WIRES

GENERAL NOTES

NO EXPANSION JOINTS WILL BE USED EXCEPT AT STRUCTURAL ENDS OR FIXED OBJECTS AS SHOWN ELSEWHERE IN THE PLANS.
JOINT AND JOINT SEAL DETAILS SHALL BE AS SHOWN ELSEWHERE IN THE PLANS.

CONSTRUCTION JOINTS MAY BE FORMED BY THE USE OF METAL OR WOOD FORMS EQUAL IN DEPTH TO THE NOMINAL DEPTH OF THE PAVEMENT, OR BY OTHER MEANS WHICH HAVE BEEN APPROVED BY THE ENGINEER PRIOR TO THEIR USE.

REFER TO TYPICAL SECTION FOR PAVEMENT WIDTH, THICKNESS, AND CROWN.

IT IS THE INTENT OF THIS DESIGN THAT THE LONGITUDINAL STEEL BE AT THE CENTER OF THE SLAB. IT SHALL BE THE RESPONSIBILITY OF THE CONTRACTOR TO TAKE ALL NECESSARY PRECAUTIONS TO INSURE THAT THE FINAL POSITION OF THE STEEL IS NOT BELOW THE CENTER OF THE SLAB.

WITHIN ANY AREA BOUNDED BY 0.6m OF PAVEMENT LENGTH MEASURED PARALLEL TO THE CENTERLINE, AND 3.6m OF PAVEMENT WIDTH MEASURED PERPENDICULAR TO THE PAVEMENT CENTERLINE, NOT OVER 33% OF THE REGULAR LONGITUDINAL STEEL SHALL BE SPLICED.

ALL SPLICES SHALL BE A MINIMUM OF 0.4m FOR LONGITUDINAL STEEL AND 0.25m FOR TRANSVERSE STEEL.

AT TRANSVERSE CONSTRUCTION JOINTS THE REGULAR LONGITUDINAL STEEL SHALL EXTEND A MINIMUM OF 1.2m ON EITHER SIDE OF THE JOINT.

IF WIDTHS GREATER THAN TYPICAL WIDTHS OCCUR, INDIVIDUAL WIRES MAY BE ADDED TO OBTAIN ADDITIONAL WIDTH, PROVIDED THE C-C SPACING IS NOT EXCEEDED AND LAP REQUIREMENTS ARE MET.

AT ALL LAP SPLICES OCCURRING WITHIN 2.4m BEYOND THE CONSTRUCTION JOINT, IN THE DIRECTION OF PAVING AND 1.2m BACK OF THE CONSTRUCTION JOINT, THE LENGTH OF LAP SHALL BE DOUBLE THAT NORMALLY SPECIFIED OR EACH SPLICE SHALL BE STRENGTHENED BY SPLICING IN SYMMETRICALLY WITH THE LAP, A 1.8m LENGTH OF DEFORMED BAR OF THE SAME NOMINAL SIZE AS THE LONGITUDINAL REINFORCEMENT.

SAWED JOINT AND JOINT SEALANT FOR TRANSVERSE CONSTRUCTION JOINT, LONGITUDINAL CONSTRUCTION JOINT AND SAWED LONGITUDINAL JOINT SHALL CONFORM TO THE DETAILS SHOWN FOR SAWED LONGITUDINAL JOINT ON STANDARD DRAWING CPTJ-6A(M).

PAVEMENT THICKNESS (T) mm	WIRE SIZE	LONGITUDINAL REINFORCEMENT								TRANS. REINF. FOR LONG. CONSTR. JOINT			
		7.2m PLACEMENT		3.6m PLACEMENT		ADDITIONAL STEEL TRANS. CONSTR. JOINT		WIRE SIZE	TIE WIRES ③				
		SPACING C-C ④ mm	STEEL kg/m sq. ①	SPACING C-C ④ mm	STEEL kg/m sq. ①	WIRE SIZE	LENGTH mm			NO. PER LANE ②	WEIGHT kg/m OF WIDTH		
200	D-19.2	50	100	11.03	50	100	10.99	D-19.2	900	16	3.92	D-8	0.612
150	D-14.4	50	100	7.98	50	100	7.96	D-14.4	900	16	2.94	D-4	0.306

TABLE NOTE

- ① INCLUDES BOTH LONGITUDINAL AND TRANSVERSE WIRES BASED ON THE WIDTH INDICATED AND AN EFFECTIVE COVER LENGTH OF 9.6m. (ESTIMATING QUANTITIES INCLUDE SPLICES)
- ② THIS SHALL BE THE MINIMUM NUMBER OF ADDITIONAL STEEL WIRES TO BE PLACED PER LANE. THE ADDITIONAL STEEL WIRES SHALL BE PLACED EQUIDISTANT BETWEEN TWO REGULAR LONGITUDINAL REINFORCING WIRES AT AS NEAR A UNIFORM SPACING ACROSS THE LANE AS POSSIBLE.
- ③ AT THE OPTION OF THE CONTRACTOR, #13 BARS X 0.75m AT 0.75m C-C MAY BE USED IN LIEU OF THE DEFORMED TIE WIRES AT 0.4m C-C SHOWN, PROVIDED WRITTEN APPROVAL HAS BEEN RECEIVED FROM THE ENGINEER.

ARKANSAS STATE HIGHWAY COMMISSION

DETAILS OF CONCRETE PAVEMENT CONTINUOUSLY REINFORCED DEFORMED WIRE MAT

STANDARD DRAWING CPCR-2 (M) **METRIC**

4-3-97	REVISED STEEL BARS TO SOFT METRIC
7-20-95	CONVERTED TO METRIC
DATE	BY