

ARKANSAS STATE HIGHWAY COMMISSION

PROPOSAL DOCUMENTS

FOR THE CONSTRUCTION OF

STATE JOB NO. **A80035**

 FEDERAL AID PROJECT STPR-0053(40)

 YELL CO. LINE – PERRY (S)

STATE HIGHWAY **10** SECTION **5**

IN **PERRY** COUNTY

Bound herein are the Supplemental Specifications, Special Provisions, Proposal Documents and Schedule of Items applicable to this proposed construction contract.

Applicable to this proposed construction contract, but not bound herein, are the Arkansas State Highway Commission Standard Specifications for Highway Construction, Edition of 2014, and the Construction Plans.



CAUTION TO BIDDERS

Please review Section 102 of the Standard Specifications, 2014 Edition for Bidding Requirements and Conditions. Mistakes or omissions can be costly. Important items for you to check are included in, but not limited to, those listed below. This checklist is furnished only to assist you in submitting a proper bid. Check as you read.

- Have you contacted ARDOT (pmd@ardot.gov or 501-569-2261) to become an eligible bidder? This is required to submit a bid in the letting and must occur by 4:30pm the day prior to the letting.
- Have you acknowledged all Addenda by email or fax?
- Is the unit price entered appropriate for the item?
- Have you entered a unit price for each bid item except in the case of authorized alternate pay items? (A zero bid (\$0.00) is a valid price and will be considered.)
- Have you checked the Schedule of Items for various pay items that may have a minimum or maximum unit bid price? (Refer to the Standard Specifications for further information concerning these items)
 - ✓ Asphalt Binder
 - ✓ Relocating Precast Concrete Barrier
 - ✓ Water
 - ✓ Mobilization
- Have you limited your bid for Mobilization to five percent (5%) of the subtotal?
- For Federal-aid projects, did you complete the Certification for Federal aid Contracts?
- Prior to submitting your bid, did you check for error messages, and are all the folders "green"?
- If submitting a paper copy of the Proposal Guaranty (Bid Bond) is it signed by an officer of your company **AND** the Surety Agent?
- Did you ensure your Proposal Guaranty (if you are submitting a paper bond) will arrive prior to the time and date stated on Page 2 of the Proposal Documents?

1-17-08
Revised: 6-1-09
Revised: 2-15-12
Revised: 1-15-15
Revised: 5-26-16
Revised: 11-17-17
Revised: 7-5-23

ARKANSAS DEPARTMENT OF TRANSPORTATION

NOTICE OF NONDISCRIMINATION

The Arkansas Department of Transportation (ARDOT) complies with all civil rights provisions of federal statutes and related authorities that prohibit discrimination in programs and activities receiving federal financial assistance. Therefore, ARDOT does not discriminate on the basis of race, sex, color, age, national origin, religion (not applicable as a protected group under the Federal Motor Carrier Safety Administration Title VI Program), disability, Limited English Proficiency (LEP), or low-income status in the admission, access to and treatment in ARDOT's programs and activities, as well as ARDOT's hiring or employment practices. Complaints of alleged discrimination and inquiries regarding ARDOT's nondiscrimination policies may be directed to Civil Rights Officer Joanna P. McFadden (ADA/504/Title VI Coordinator), P. O. Box 2261, Little Rock, Arkansas 72203-2261, (501) 569-2298, (Voice/TTY 711), or the following email address: joanna.mcfadden@ardot.gov.

Free language assistance for Limited English Proficient individuals is available upon request.

This notice is available from the ADA/504/Title VI Coordinator in large print, on audiotape and in Braille.

TITLE VI CONTRACT PROVISIONS

APPENDIX A

During the performance of this contract, the contractor, for itself, its assignees and successors in interest (hereinafter referred to as the “contractor”) agrees as follows:

(1) Compliance with Regulations: The contractor (hereinafter includes consultants) will comply with the Acts and the Regulations relative to Non-discrimination in Federally-assisted programs of the U.S. Department of Transportation, Federal Highway Administration, as they may be amended from time to time, which are herein incorporated by reference and made a part of this contract.

(2) Nondiscrimination: The contractor, with regard to the work performed by it during the contract, will not discriminate on the grounds of race, color, or national origin in the selection and retention of subcontractors, including procurements of materials and leases of equipment. The contractor will not participate directly or indirectly in the discrimination prohibited by the Acts and the Regulations, including employment practices when the contract covers any activity, project, or program set forth in Appendix B of 49 CFR Part 21.

(3) Solicitations for Subcontracts, Including Procurements of Materials and Equipment: In all solicitations, either by competitive bidding, or negotiation made by the contractor for work to be performed under a subcontract, including procurements of materials, or leases of equipment, each potential subcontractor or supplier will be notified by the contractor of the contractor's obligations under this contract and the Acts and the Regulations relative to Nondiscrimination on the grounds of race, color, or national origin.

(4) Information and Reports: The contractor will provide all information and reports required by the Acts, the Regulations, and directives issued pursuant thereto and will permit access to its books, records, accounts, other sources of information, and its facilities as may be determined by the Recipient or the Federal Highway Administration to be pertinent to ascertain compliance with such Acts, Regulations, and instructions. Where any information required of a contractor is in the exclusive possession of another who fails or refuses to furnish the information, the contractor will so certify to the Recipient or the Federal Highway Administration, as appropriate, and will set forth what efforts it has made to obtain the information.

(5) Sanctions for Noncompliance: In the event of a contractor's noncompliance with the Nondiscrimination provisions of this contract, the Recipient will impose such contract sanctions as it or the Federal Highway Administration may determine to be appropriate, including, but not limited to:

- (a) Withholding of payments to the contractor under the contract until the contractor complies, and/or
- (b) Cancelling, terminating or suspending a contract, in whole or in part.

(6) Incorporation of Provisions: The contractor will include the provisions of paragraphs one through six in every subcontract, including procurements of materials and leases of equipment, unless exempt by the Acts, the Regulations and directives issued pursuant thereto. The contractor will take action with respect to any subcontract or procurement as the Recipient or the Federal Highway Administration may direct as a means of enforcing such provisions including sanctions for noncompliance. Provided, that if the contractor becomes involved in, or is threatened with litigation by a subcontractor, or supplier because of such direction, the contractor may request the Recipient to enter into any litigation to protect the interests of the Recipient. In addition, the contractor may request the United States to enter into the litigation to protect the interests of the United States.

TITLE VI CONTRACT PROVISIONS

APPENDIX E

During the performance of this contract, the contractor, for itself, its assignees, and successors in interest (hereinafter referred to as the "contractor") agrees to comply with the following non-discrimination statutes and authorities; including but not limited to:

Pertinent Non-Discrimination Authorities:

- Title VI of the Civil Rights Act of 1964 (42 U.S.C. § 2000d et seq., 78 stat. 252), (prohibits discrimination on the basis of race, color, national origin); and 49 CFR Part 21.
- The Uniform Relocation Assistance and Real Property Acquisition Policies Act of 1970, (42 U.S.C. § 4601), (prohibits unfair treatment of persons displaced or whose property has been acquired because of Federal or Federal-aid programs and projects);
- Federal-Aid Highway Act of 1973, (23 U.S.C. § 324 et seq.), (prohibits discrimination on the basis of sex);
- Section 504 of the Rehabilitation Act of 1973, (29 U.S.C. § 794 et seq.), as amended, (prohibits discrimination on the basis of disability); and 49 CFR Part 27;
- The Age Discrimination Act of 1975, as amended, (42 U.S.C. § 6101 et seq.), (prohibits discrimination on the basis of age);
- Airport and Airway Improvement Act of 1982, (49 USC§ 471, Section 47123), as amended, (prohibits discrimination based on race, creed, color, national origin, or sex);
- The Civil Rights Restoration Act of 1987, (PL 100-209), (Broadened the scope, coverage and applicability of Title VI of the Civil Rights Act of 1964, The Age Discrimination Act of 1975 and Section 504 of the Rehabilitation Act of 1973, by expanding the definition of the terms "programs or activities" to include all of the programs or activities of the Federal-aid recipients, sub-recipients and contractors, whether such programs or activities are Federally funded or not);
- Titles II and III of the Americans with Disabilities Act, which prohibit discrimination on the basis of disability in the operation of public entities, public and private transportation systems, places of public accommodation, and certain testing entities (42 U.S.C. §§ 12131-12189) as implemented by Department of Transportation regulations at 49 C.F.R. parts 37 and 38;
- The Federal Aviation Administration's Non-discrimination statute (49 U.S.C. § 47123) (prohibits discrimination on the basis of race, color, national origin, and sex);
- Executive Order 12898, Federal Actions to Address Environmental Justice in Minority Populations and Low-Income Populations, which ensures Non-discrimination against minority populations by discouraging programs, policies, and activities with disproportionately high and adverse human health or environmental effects on minority and low-income populations;
- Executive Order 13166, Improving Access to Services for Persons with Limited English Proficiency, and resulting agency guidance, national origin discrimination includes discrimination because of Limited English proficiency (LEP). To ensure compliance with Title VI, you must take reasonable steps to ensure that LEP persons have meaningful access to your programs (70 Fed. Reg. at 74087 to 74100);
- Title IX of the Education Amendments of 1972, as amended, which prohibits you from discriminating because of sex in education programs or activities (20 U.S.C. 1681et seq).

Arkansas Department of Transportation
Supplemental Specifications and Special Provisions Listing
State Job Number A80035

The following supplemental specifications and special provisions for this project supplement the standard specifications, edition of 2014. In case of conflict, the supplemental specifications and special provisions shall govern.

ERRATA	ERRATA FOR THE BOOK OF STANDARD SPECIFICATIONS
FHWA-1273	REQUIRED CONTRACT PROVISIONS FEDERAL-AID CONSTRUCTION CONTRACTS
FHWA-1273	SUPPLEMENT - EQUAL EMPLOYMENT OPPORTUNITY - NOTICE TO CONTRACTORS
FHWA-1273	SUPPLEMENT - SPECIFIC EQUAL EMPLOYMENT OPPORTUNITY RESPONSIBILITIES (23 U.S.C. 140)
FHWA-1273	SUPPLEMENT - EQUAL EMPLOYMENT OPPORTUNITY - GOALS AND TIMETABLES
FHWA-1273	SUPPLEMENT - EQUAL EMPLOYMENT OPPORTUNITY - FEDERAL STANDARDS
FHWA-1273	SUPPLEMENT - POSTERS AND NOTICES REQUIRED FOR FEDERAL-AID PROJECTS
FHWA-1273	SUPPLEMENT - WAGE RATE DETERMINATION
JOB SP	CARGO PREFERENCE ACT REQUIREMENTS
JOB SP	GOALS FOR DISADVANTAGED BUSINESS ENTERPRISE PARTICIPATION
JOB SP	DISADVANTAGED BUSINESS ENTERPRISE BIDDER'S RESPONSIBILITIES
JOB SP	PROHIBITION OF CERTAIN TELECOMMUNICATIONS AND VIDEO SURVEILLANCE SERVICES OR EQUIPMENT
JOB SP	BUY AMERICA - CONSTRUCTION MATERIALS
JOB SP	BIDDING REQUIREMENTS AND CONDITIONS
JOB SP	MANDATORY ELECTRONIC CONTRACT
JOB SP	MANDATORY ELECTRONIC DOCUMENT SUBMITTAL
JOB SP	LIQUIDATED DAMAGES PROCEDURE FOR BID LETTINGS
JOB SP	AGGREGATE SURFACE COURSE
JOB SP	DESIGN AND QUALITY CONTROL OF ASPHALT MIXTURES
JOB SP	PERCENT AIR VOIDS AND NDESIGN FOR ACHM SURFACE MIX DESIGNS
JOB SP	LONGITUDINAL JOINT DENSITIES FOR ACHM SURFACE COURSES
JOB SP	SUBMISSION OF ASPHALT CONCRETE HOT MIX ACCEPTANCE TEST RESULTS
JOB SP	PRICE ADJUSTMENT FOR ASPHALT BINDER
JOB SP	HIGH PERFORMANCE COLD MIX
JOB SP	DESIGN OF ASPHALT MIXTURES - AGGREGATES
JOB SP	PRICE ADJUSTMENT FOR FUEL
JOB SP	BROADBAND INTERNET SERVICE FOR ASPHALT CONCRETE PLANT
JOB SP	WARM MIX ASPHALT
JOB SP	COLD MILLING - MILL & INLAY
JOB SP	RUMBLE STRIPS
SP 108-1	LIQUIDATED DAMAGES
SS 100-3	CONTRACTOR'S LICENSE
SS 100-4	DEPARTMENT NAME CHANGE
SS 102-2	ISSUANCE OF PROPOSALS
SS 103-2	CONTACT INFORMATION FOR MOTORIST DAMAGE CLAIMS

Arkansas Department of Transportation
Supplemental Specifications and Special Provisions Listing
State Job Number A80035

The following supplemental specifications and special provisions for this project supplement the standard specifications, edition of 2014. In case of conflict, the supplemental specifications and special provisions shall govern.

SS 105-4	MAINTENANCE DURING CONSTRUCTION
SS 107-2	RESTRAINING CONDITIONS
SS 108-2	WORK ALLOWED PRIOR TO ISSUANCE OF WORK ORDER
SS 108-3	WORK ORDER FOR FIXED COMPLETION DATE CONTRACTS
SS 303-1	AGGREGATE BASE COURSE
SS 306-1	QUALITY CONTROL AND ACCEPTANCE
SS 400-1	TACK COATS
SS 400-4	DESIGN AND QUALITY CONTROL OF ASPHALT MIXTURES
SS 400-5	PERCENT AIR VOIDS FOR ACHM MIX DESIGNS
SS 400-6	LIQUID ANTI-STRIP ADDITIVE
SS 400-7	TRACKLESS TACK
SS 404-3	DESIGN OF ASPHALT MIXTURES
SS 409-2	ASPHALT LABORATORY FACILITY
SS 410-1	CONSTRUCTION REQUIREMENTS AND ACCEPTANCE OF ASPHALT CONCRETE PLANT MIX COURSES
SS 410-2	DEVICES FOR MEASURING DENSITY FOR ROLLING PATTERNS
SS 410-4	EVALUATION OF ACHM SUBLOT REPLACEMENT MATERIAL
SS 416-1	RECYCLED ASPHALT PAVEMENT
SS 600-2	INCIDENTAL CONSTRUCTION
SS 603-1	LANE CLOSURE NOTIFICATION
SS 604-1	RETROREFLECTIVE SHEETING FOR TRAFFIC CONTROL DEVICES IN CONSTRUCTION ZONES
SS 604-3	TRAFFIC CONTROL DEVICES IN CONSTRUCTION ZONES (MASH)
SS 617-1	GUARDRAIL TERMINAL (TYPE 2)
SS 617-2	GUARDRAIL DELINEATORS
SS 802-4	CEMENT

ARKANSAS DEPARTMENT OF TRANSPORTATION

SUPPLEMENTAL SPECIFICATION

ERRATA FOR THE BOOK OF STANDARD SPECIFICATIONS

Errors noted in the printed book of Standard Specifications for Highway Construction, Edition of 2014, are listed below and this publication is hereby revised as follows:

- Page 124: The third sentence of the first paragraph of Subsection 110.03(c) should read: The Engineer will make a decision within 10 business days concerning the necessity or practicability of the request.
- Page 195: The sixth paragraph of subsection 303.02 should read: For Classes 1 through 8 materials, the fraction passing the #200 (0.075 mm) sieve shall not be greater than three-fourths of the fraction passing the #40 (0.0425 mm) sieve. For Classes 3 through 8, the fraction passing the #40 (0.425 mm) sieve shall have a liquid limit not greater than 25.
- Page 363: In the second paragraph of Subsection 502.02, the reference to ASTM 775 should be replaced by “ASTM A 775”.
- Page 636: In the second paragraph of Subsection 730.02, the references to AASHTO M 183 should be replaced with ASTM A36.
- Page 637: The last sentence of the second paragraph of Subsection 730.03 should read: All bolts, nuts, and washers shall be galvanized according to AASHTO M 232 or ASTM B 695, Class 40 or 50.
- Page 767: In the fourth paragraph of Subsection 807.06(a), the reference to ASTM B595 should be replaced by “ASTM B695”.
- Page 841: Subsection 817.04(a) should read: The treatment of lumber and timber shall meet the applicable requirements of the current edition of the AWWA, Standards U1, Commodity Specification E, Use Category UC4C.

**REQUIRED CONTRACT PROVISIONS
FEDERAL-AID CONSTRUCTION CONTRACTS**

- I. General
- II. Nondiscrimination
- III. Non-segregated Facilities
- IV. Davis-Bacon and Related Act Provisions
- V. Contract Work Hours and Safety Standards Act Provisions
- VI. Subletting or Assigning the Contract
- VII. Safety: Accident Prevention
- VIII. False Statements Concerning Highway Projects
- IX. Implementation of Clean Air Act and Federal Water Pollution Control Act
- X. Certification Regarding Debarment, Suspension, Ineligibility and Voluntary Exclusion
- XI. Certification Regarding Use of Contract Funds for Lobbying
- XII. Use of United States-Flag Vessels:

performed on the contract by the contractor's own organization and with the assistance of workers under the contractor's immediate superintendence and to all work performed on the contract by piecework, station work, or by subcontract. 23 CFR 633.102(d).

3. A breach of any of the stipulations contained in these Required Contract Provisions may be sufficient grounds for withholding of progress payments, withholding of final payment, termination of the contract, suspension / debarment or any other action determined to be appropriate by the contracting agency and FHWA.

4. Selection of Labor: During the performance of this contract, the contractor shall not use convict labor for any purpose within the limits of a construction project on a Federal-aid highway unless it is labor performed by convicts who are on parole, supervised release, or probation. 23 U.S.C. 114(b). The term Federal-aid highway does not include roadways functionally classified as local roads or rural minor collectors. 23 U.S.C. 101(a).

ATTACHMENTS

A. Employment and Materials Preference for Appalachian Development Highway System or Appalachian Local Access Road Contracts (included in Appalachian contracts only)

II. NONDISCRIMINATION (23 CFR 230.107(a); 23 CFR Part 230, Subpart A, Appendix A; EO 11246)

I. GENERAL

The provisions of this section related to 23 CFR Part 230, Subpart A, Appendix A are applicable to all Federal-aid construction contracts and to all related construction subcontracts of \$10,000 or more. The provisions of 23 CFR Part 230 are not applicable to material supply, engineering, or architectural service contracts.

1. Form FHWA-1273 must be physically incorporated in each construction contract funded under title 23, United States Code, as required in 23 CFR 633.102(b) (excluding emergency contracts solely intended for debris removal). The contractor (or subcontractor) must insert this form in each subcontract and further require its inclusion in all lower tier subcontracts (excluding purchase orders, rental agreements and other agreements for supplies or services). 23 CFR 633.102(e).

In addition, the contractor and all subcontractors must comply with the following policies: Executive Order 11246, 41 CFR Part 60, 29 CFR Parts 1625-1627, 23 U.S.C. 140, Section 504 of the Rehabilitation Act of 1973, as amended (29 U.S.C. 794), Title VI of the Civil Rights Act of 1964, as amended (42 U.S.C. 2000d et seq.), and related regulations including 49 CFR Parts 21, 26, and 27; and 23 CFR Parts 200, 230, and 633.

The applicable requirements of Form FHWA-1273 are incorporated by reference for work done under any purchase order, rental agreement or agreement for other services. The prime contractor shall be responsible for compliance by any subcontractor, lower-tier subcontractor or service provider. 23 CFR 633.102(e).

The contractor and all subcontractors must comply with: the requirements of the Equal Opportunity Clause in 41 CFR 60-1.4(b) and, for all construction contracts exceeding \$10,000, the Standard Federal Equal Employment Opportunity Construction Contract Specifications in 41 CFR 60-4.3.

Form FHWA-1273 must be included in all Federal-aid design-build contracts, in all subcontracts and in lower tier subcontracts (excluding subcontracts for design services, purchase orders, rental agreements and other agreements for supplies or services) in accordance with 23 CFR 633.102. The design-builder shall be responsible for compliance by any subcontractor, lower-tier subcontractor or service provider.

Note: The U.S. Department of Labor has exclusive authority to determine compliance with Executive Order 11246 and the policies of the Secretary of Labor including 41 CFR Part 60, and 29 CFR Parts 1625-1627. The contracting agency and the FHWA have the authority and the responsibility to ensure compliance with 23 U.S.C. 140, Section 504 of the Rehabilitation Act of 1973, as amended (29 U.S.C. 794), and Title VI of the Civil Rights Act of 1964, as amended (42 U.S.C. 2000d et seq.), and related regulations including 49 CFR Parts 21, 26, and 27; and 23 CFR Parts 200, 230, and 633.

Contracting agencies may reference Form FHWA-1273 in solicitation-for-bids or request-for-proposals documents, however, the Form FHWA-1273 must be physically incorporated (not referenced) in all contracts, subcontracts and lower-tier subcontracts (excluding purchase orders, rental agreements and other agreements for supplies or services related to a construction contract). 23 CFR 633.102(b).

The following provision is adopted from 23 CFR Part 230, Subpart A, Appendix A, with appropriate revisions to conform to the U.S. Department of Labor (US DOL) and FHWA requirements.

2. Subject to the applicability criteria noted in the following sections, these contract provisions shall apply to all work

1. Equal Employment Opportunity: Equal Employment Opportunity (EEO) requirements not to discriminate and to take affirmative action to assure equal opportunity as set forth under laws, executive orders, rules, regulations (see 28 CFR Part 35, 29 CFR Part 1630, 29 CFR Parts 1625-1627, 41 CFR Part 60 and 49 CFR Part 27) and orders of the Secretary of Labor as modified by the provisions prescribed herein, and imposed pursuant to 23 U.S.C. 140, shall constitute the EEO and specific affirmative action standards for the contractor's project activities under this contract. The provisions of the Americans with Disabilities Act of 1990 (42 U.S.C. 12101 et seq.) set forth under 28 CFR Part 35 and 29 CFR Part 1630 are incorporated by reference in this contract. In the execution of this contract, the contractor agrees to comply with the following minimum specific requirement activities of EEO:

a. The contractor will work with the contracting agency and the Federal Government to ensure that it has made every good faith effort to provide equal opportunity with respect to all of its terms and conditions of employment and in their review of activities under the contract. 23 CFR 230.409 (g)(4) & (5).

b. The contractor will accept as its operating policy the following statement:

"It is the policy of this Company to assure that applicants are employed, and that employees are treated during employment, without regard to their race, religion, sex, sexual orientation, gender identity, color, national origin, age or disability. Such action shall include: employment, upgrading, demotion, or transfer; recruitment or recruitment advertising; layoff or termination; rates of pay or other forms of compensation; and selection for training, including apprenticeship, pre-apprenticeship, and/or on-the-job training."

2. EEO Officer: The contractor will designate and make known to the contracting officers an EEO Officer who will have the responsibility for and must be capable of effectively administering and promoting an active EEO program and who must be assigned adequate authority and responsibility to do so.

3. Dissemination of Policy: All members of the contractor's staff who are authorized to hire, supervise, promote, and discharge employees, or who recommend such action or are substantially involved in such action, will be made fully cognizant of and will implement the contractor's EEO policy and contractual responsibilities to provide EEO in each grade and classification of employment. To ensure that the above agreement will be met, the following actions will be taken as a minimum:

a. Periodic meetings of supervisory and personnel office employees will be conducted before the start of work and then not less often than once every six months, at which time the contractor's EEO policy and its implementation will be reviewed and explained. The meetings will be conducted by the EEO Officer or other knowledgeable company official.

b. All new supervisory or personnel office employees will be given a thorough indoctrination by the EEO Officer, covering all major aspects of the contractor's EEO obligations within thirty days following their reporting for duty with the contractor.

c. All personnel who are engaged in direct recruitment for the project will be instructed by the EEO Officer in the contractor's procedures for locating and hiring minorities and women.

d. Notices and posters setting forth the contractor's EEO policy will be placed in areas readily accessible to employees, applicants for employment and potential employees.

e. The contractor's EEO policy and the procedures to implement such policy will be brought to the attention of employees by means of meetings, employee handbooks, or other appropriate means.

4. Recruitment: When advertising for employees, the contractor will include in all advertisements for employees the notation: "An Equal Opportunity Employer." All such advertisements will be placed in publications having a large circulation among minorities and women in the area from which the project work force would normally be derived.

a. The contractor will, unless precluded by a valid bargaining agreement, conduct systematic and direct recruitment through public and private employee referral sources likely to yield qualified minorities and women. To meet this requirement, the contractor will identify sources of potential minority group employees and establish with such identified sources procedures whereby minority and women applicants may be referred to the contractor for employment consideration.

b. In the event the contractor has a valid bargaining agreement providing for exclusive hiring hall referrals, the contractor is expected to observe the provisions of that agreement to the extent that the system meets the contractor's compliance with EEO contract provisions. Where implementation of such an agreement has the effect of discriminating against minorities or women, or obligates the contractor to do the same, such implementation violates Federal nondiscrimination provisions.

c. The contractor will encourage its present employees to refer minorities and women as applicants for employment. Information and procedures with regard to referring such applicants will be discussed with employees.

5. Personnel Actions: Wages, working conditions, and employee benefits shall be established and administered, and personnel actions of every type, including hiring, upgrading, promotion, transfer, demotion, layoff, and termination, shall be taken without regard to race, color, religion, sex, sexual orientation, gender identity, national origin, age or disability. The following procedures shall be followed:

a. The contractor will conduct periodic inspections of project sites to ensure that working conditions and employee facilities do not indicate discriminatory treatment of project site personnel.

b. The contractor will periodically evaluate the spread of wages paid within each classification to determine any evidence of discriminatory wage practices.

c. The contractor will periodically review selected personnel actions in depth to determine whether there is evidence of discrimination. Where evidence is found, the contractor will promptly take corrective action. If the review indicates that the discrimination may extend beyond the actions reviewed, such corrective action shall include all affected persons.

d. The contractor will promptly investigate all complaints of alleged discrimination made to the contractor in connection with its obligations under this contract, will attempt to resolve such complaints, and will take appropriate corrective action

within a reasonable time. If the investigation indicates that the discrimination may affect persons other than the complainant, such corrective action shall include such other persons. Upon completion of each investigation, the contractor will inform every complainant of all of their avenues of appeal.

6. Training and Promotion:

a. The contractor will assist in locating, qualifying, and increasing the skills of minorities and women who are applicants for employment or current employees. Such efforts should be aimed at developing full journey level status employees in the type of trade or job classification involved.

b. Consistent with the contractor's work force requirements and as permissible under Federal and State regulations, the contractor shall make full use of training programs (i.e., apprenticeship and on-the-job training programs for the geographical area of contract performance). In the event a special provision for training is provided under this contract, this subparagraph will be superseded as indicated in the special provision. The contracting agency may reserve training positions for persons who receive welfare assistance in accordance with 23 U.S.C. 140(a).

c. The contractor will advise employees and applicants for employment of available training programs and entrance requirements for each.

d. The contractor will periodically review the training and promotion potential of employees who are minorities and women and will encourage eligible employees to apply for such training and promotion.

7. Unions: If the contractor relies in whole or in part upon unions as a source of employees, the contractor will use good faith efforts to obtain the cooperation of such unions to increase opportunities for minorities and women. 23 CFR 230.409. Actions by the contractor, either directly or through a contractor's association acting as agent, will include the procedures set forth below:

a. The contractor will use good faith efforts to develop, in cooperation with the unions, joint training programs aimed toward qualifying more minorities and women for membership in the unions and increasing the skills of minorities and women so that they may qualify for higher paying employment.

b. The contractor will use good faith efforts to incorporate an EEO clause into each union agreement to the end that such union will be contractually bound to refer applicants without regard to their race, color, religion, sex, sexual orientation, gender identity, national origin, age, or disability.

c. The contractor is to obtain information as to the referral practices and policies of the labor union except that to the extent such information is within the exclusive possession of the labor union and such labor union refuses to furnish such information to the contractor, the contractor shall so certify to the contracting agency and shall set forth what efforts have been made to obtain such information.

d. In the event the union is unable to provide the contractor with a reasonable flow of referrals within the time limit set forth in the collective bargaining agreement, the contractor will, through independent recruitment efforts, fill the employment vacancies without regard to race, color, religion, sex, sexual orientation, gender identity, national origin, age, or disability; making full efforts to obtain qualified and/or qualifiable minorities and women. The failure of a union to provide

sufficient referrals (even though it is obligated to provide exclusive referrals under the terms of a collective bargaining agreement) does not relieve the contractor from the requirements of this paragraph. In the event the union referral practice prevents the contractor from meeting the obligations pursuant to Executive Order 11246, as amended, and these special provisions, such contractor shall immediately notify the contracting agency.

8. Reasonable Accommodation for Applicants / Employees with Disabilities: The contractor must be familiar with the requirements for and comply with the Americans with Disabilities Act and all rules and regulations established thereunder. Employers must provide reasonable accommodation in all employment activities unless to do so would cause an undue hardship.

9. Selection of Subcontractors, Procurement of Materials and Leasing of Equipment: The contractor shall not discriminate on the grounds of race, color, religion, sex, sexual orientation, gender identity, national origin, age, or disability in the selection and retention of subcontractors, including procurement of materials and leases of equipment. The contractor shall take all necessary and reasonable steps to ensure nondiscrimination in the administration of this contract.

a. The contractor shall notify all potential subcontractors, suppliers, and lessors of their EEO obligations under this contract.

b. The contractor will use good faith efforts to ensure subcontractor compliance with their EEO obligations.

10. Assurances Required:

a. The requirements of 49 CFR Part 26 and the State DOT's FHWA-approved Disadvantaged Business Enterprise (DBE) program are incorporated by reference.

b. The contractor, subrecipient or subcontractor shall not discriminate on the basis of race, color, national origin, or sex in the performance of this contract. The contractor shall carry out applicable requirements of 49 CFR part 26 in the award and administration of DOT-assisted contracts. Failure by the contractor to carry out these requirements is a material breach of this contract, which may result in the termination of this contract or such other remedy as the recipient deems appropriate, which may include, but is not limited to:

- (1) Withholding monthly progress payments;
- (2) Assessing sanctions;
- (3) Liquidated damages; and/or
- (4) Disqualifying the contractor from future bidding as non-responsible.

c. The Title VI and nondiscrimination provisions of U.S. DOT Order 1050.2A at Appendixes A and E are incorporated by reference. 49 CFR Part 21.

11. Records and Reports: The contractor shall keep such records as necessary to document compliance with the EEO requirements. Such records shall be retained for a period of three years following the date of the final payment to the contractor for all contract work and shall be available at reasonable times and places for inspection by authorized representatives of the contracting agency and the FHWA.

a. The records kept by the contractor shall document the following:

(1) The number and work hours of minority and non-minority group members and women employed in each work classification on the project;

(2) The progress and efforts being made in cooperation with unions, when applicable, to increase employment opportunities for minorities and women; and

(3) The progress and efforts being made in locating, hiring, training, qualifying, and upgrading minorities and women.

b. The contractors and subcontractors will submit an annual report to the contracting agency each July for the duration of the project indicating the number of minority, women, and non-minority group employees currently engaged in each work classification required by the contract work. This information is to be reported on [Form FHWA-1391](#). The staffing data should represent the project work force on board in all or any part of the last payroll period preceding the end of July. If on-the-job training is being required by special provision, the contractor will be required to collect and report training data. The employment data should reflect the work force on board during all or any part of the last payroll period preceding the end of July.

III. NONSEGREGATED FACILITIES

This provision is applicable to all Federal-aid construction contracts and to all related construction subcontracts of more than \$10,000. 41 CFR 60-1.5.

As prescribed by 41 CFR 60-1.8, the contractor must ensure that facilities provided for employees are provided in such a manner that segregation on the basis of race, color, religion, sex, sexual orientation, gender identity, or national origin cannot result. The contractor may neither require such segregated use by written or oral policies nor tolerate such use by employee custom. The contractor's obligation extends further to ensure that its employees are not assigned to perform their services at any location under the contractor's control where the facilities are segregated. The term "facilities" includes waiting rooms, work areas, restaurants and other eating areas, time clocks, restrooms, washrooms, locker rooms and other storage or dressing areas, parking lots, drinking fountains, recreation or entertainment areas, transportation, and housing provided for employees. The contractor shall provide separate or single-user restrooms and necessary dressing or sleeping areas to assure privacy between sexes.

IV. DAVIS-BACON AND RELATED ACT PROVISIONS

This section is applicable to all Federal-aid construction projects exceeding \$2,000 and to all related subcontracts and lower-tier subcontracts (regardless of subcontract size), in accordance with 29 CFR 5.5. The requirements apply to all projects located within the right-of-way of a roadway that is functionally classified as Federal-aid highway. 23 U.S.C. 113. This excludes roadways functionally classified as local roads or rural minor collectors, which are exempt. 23 U.S.C. 101. Where applicable law requires that projects be treated as a project on a Federal-aid highway, the provisions of this subpart will apply regardless of the location of the project. Examples include: Surface Transportation Block Grant Program projects funded under 23 U.S.C. 133 [excluding recreational trails projects], the Nationally Significant Freight and Highway

Projects funded under 23 U.S.C. 117, and National Highway Freight Program projects funded under 23 U.S.C. 167.

The following provisions are from the U.S. Department of Labor regulations in 29 CFR 5.5 "Contract provisions and related matters" with minor revisions to conform to the FHWA-1273 format and FHWA program requirements.

1. Minimum wages (29 CFR 5.5)

a. *Wage rates and fringe benefits.* All laborers and mechanics employed or working upon the site of the work (or otherwise working in construction or development of the project under a development statute), will be paid unconditionally and not less often than once a week, and without subsequent deduction or rebate on any account (except such payroll deductions as are permitted by regulations issued by the Secretary of Labor under the Copeland Act ([29 CFR part 3](#))), the full amount of basic hourly wages and bona fide fringe benefits (or cash equivalents thereof) due at time of payment computed at rates not less than those contained in the wage determination of the Secretary of Labor which is attached hereto and made a part hereof, regardless of any contractual relationship which may be alleged to exist between the contractor and such laborers and mechanics. As provided in paragraphs (d) and (e) of 29 CFR 5.5, the appropriate wage determinations are effective by operation of law even if they have not been attached to the contract. Contributions made or costs reasonably anticipated for bona fide fringe benefits under the Davis-Bacon Act ([40 U.S.C. 3141\(2\)\(B\)](#)) on behalf of laborers or mechanics are considered wages paid to such laborers or mechanics, subject to the provisions of paragraph 1.e. of this section; also, regular contributions made or costs incurred for more than a weekly period (but not less often than quarterly) under plans, funds, or programs which cover the particular weekly period, are deemed to be constructively made or incurred during such weekly period. Such laborers and mechanics must be paid the appropriate wage rate and fringe benefits on the wage determination for the classification(s) of work actually performed, without regard to skill, except as provided in paragraph 4. of this section. Laborers or mechanics performing work in more than one classification may be compensated at the rate specified for each classification for the time actually worked therein: *Provided*, That the employer's payroll records accurately set forth the time spent in each classification in which work is performed. The wage determination (including any additional classifications and wage rates conformed under paragraph 1.c. of this section) and the Davis-Bacon poster (WH-1321) must be posted at all times by the contractor and its subcontractors at the site of the work in a prominent and accessible place where it can be easily seen by the workers.

b. *Frequently recurring classifications.* (1) In addition to wage and fringe benefit rates that have been determined to be prevailing under the procedures set forth in [29 CFR part 1](#), a wage determination may contain, pursuant to § 1.3(f), wage and fringe benefit rates for classifications of laborers and mechanics for which conformance requests are regularly submitted pursuant to paragraph 1.c. of this section, provided that:

(i) The work performed by the classification is not performed by a classification in the wage determination for which a prevailing wage rate has been determined;

(ii) The classification is used in the area by the construction industry; and

(iii) The wage rate for the classification bears a reasonable relationship to the prevailing wage rates contained in the wage determination.

(2) The Administrator will establish wage rates for such classifications in accordance with paragraph 1.c.(1)(iii) of this section. Work performed in such a classification must be paid at no less than the wage and fringe benefit rate listed on the wage determination for such classification.

c. *Conformance.* (1) The contracting officer must require that any class of laborers or mechanics, including helpers, which is not listed in the wage determination and which is to be employed under the contract be classified in conformance with the wage determination. Conformance of an additional classification and wage rate and fringe benefits is appropriate only when the following criteria have been met:

(i) The work to be performed by the classification requested is not performed by a classification in the wage determination; and

(ii) The classification is used in the area by the construction industry; and

(iii) The proposed wage rate, including any bona fide fringe benefits, bears a reasonable relationship to the wage rates contained in the wage determination.

(2) The conformance process may not be used to split, subdivide, or otherwise avoid application of classifications listed in the wage determination.

(3) If the contractor and the laborers and mechanics to be employed in the classification (if known), or their representatives, and the contracting officer agree on the classification and wage rate (including the amount designated for fringe benefits where appropriate), a report of the action taken will be sent by the contracting officer by email to DBAconformance@dol.gov. The Administrator, or an authorized representative, will approve, modify, or disapprove every additional classification action within 30 days of receipt and so advise the contracting officer or will notify the contracting officer within the 30-day period that additional time is necessary.

(4) In the event the contractor, the laborers or mechanics to be employed in the classification or their representatives, and the contracting officer do not agree on the proposed classification and wage rate (including the amount designated for fringe benefits, where appropriate), the contracting officer will, by email to DBAconformance@dol.gov, refer the questions, including the views of all interested parties and the recommendation of the contracting officer, to the Administrator for determination. The Administrator, or an authorized representative, will issue a determination within 30 days of receipt and so advise the contracting officer or will notify the contracting officer within the 30-day period that additional time is necessary.

(5) The contracting officer must promptly notify the contractor of the action taken by the Wage and Hour Division

under paragraphs 1.c.(3) and (4) of this section. The contractor must furnish a written copy of such determination to each affected worker or it must be posted as a part of the wage determination. The wage rate (including fringe benefits where appropriate) determined pursuant to paragraph 1.c.(3) or (4) of this section must be paid to all workers performing work in the classification under this contract from the first day on which work is performed in the classification.

d. *Fringe benefits not expressed as an hourly rate.* Whenever the minimum wage rate prescribed in the contract for a class of laborers or mechanics includes a fringe benefit which is not expressed as an hourly rate, the contractor may either pay the benefit as stated in the wage determination or may pay another bona fide fringe benefit or an hourly cash equivalent thereof.

e. *Unfunded plans.* If the contractor does not make payments to a trustee or other third person, the contractor may consider as part of the wages of any laborer or mechanic the amount of any costs reasonably anticipated in providing bona fide fringe benefits under a plan or program, *Provided*, That the Secretary of Labor has found, upon the written request of the contractor, in accordance with the criteria set forth in § 5.28, that the applicable standards of the Davis-Bacon Act have been met. The Secretary of Labor may require the contractor to set aside in a separate account assets for the meeting of obligations under the plan or program.

f. *Interest.* In the event of a failure to pay all or part of the wages required by the contract, the contractor will be required to pay interest on any underpayment of wages.

2. Withholding (29 CFR 5.5)

a. *Withholding requirements.* The contracting agency may, upon its own action, or must, upon written request of an authorized representative of the Department of Labor, withhold or cause to be withheld from the contractor so much of the accrued payments or advances as may be considered necessary to satisfy the liabilities of the prime contractor or any subcontractor for the full amount of wages and monetary relief, including interest, required by the clauses set forth in this section for violations of this contract, or to satisfy any such liabilities required by any other Federal contract, or federally assisted contract subject to Davis-Bacon labor standards, that is held by the same prime contractor (as defined in § 5.2). The necessary funds may be withheld from the contractor under this contract, any other Federal contract with the same prime contractor, or any other federally assisted contract that is subject to Davis-Bacon labor standards requirements and is held by the same prime contractor, regardless of whether the other contract was awarded or assisted by the same agency, and such funds may be used to satisfy the contractor liability for which the funds were withheld. In the event of a contractor's failure to pay any laborer or mechanic, including any apprentice or helper working on the site of the work all or part of the wages required by the contract, or upon the contractor's failure to submit the required records as discussed in paragraph 3.d. of this section, the contracting agency may on its own initiative and after written notice to the contractor, take such action as may be necessary to cause the suspension of any further payment, advance, or guarantee of funds until such violations have ceased.

b. *Priority to withheld funds.* The Department has priority to funds withheld or to be withheld in accordance with paragraph

2.a. of this section or Section V, paragraph 3.a., or both, over claims to those funds by:

- (1) A contractor's surety(ies), including without limitation performance bond sureties and payment bond sureties;
- (2) A contracting agency for its procurement costs;
- (3) A trustee(s) (either a court-appointed trustee or a U.S. trustee, or both) in bankruptcy of a contractor, or a contractor's bankruptcy estate;
- (4) A contractor's assignee(s);
- (5) A contractor's successor(s); or
- (6) A claim asserted under the Prompt Payment Act, [31 U.S.C. 3901–3907](#).

3. Records and certified payrolls (29 CFR 5.5)

a. *Basic record requirements (1) Length of record retention.* All regular payrolls and other basic records must be maintained by the contractor and any subcontractor during the course of the work and preserved for all laborers and mechanics working at the site of the work (or otherwise working in construction or development of the project under a development statute) for a period of at least 3 years after all the work on the prime contract is completed.

(2) *Information required.* Such records must contain the name; Social Security number; last known address, telephone number, and email address of each such worker; each worker's correct classification(s) of work actually performed; hourly rates of wages paid (including rates of contributions or costs anticipated for bona fide fringe benefits or cash equivalents thereof of the types described in [40 U.S.C. 3141\(2\)\(B\)](#) of the Davis-Bacon Act); daily and weekly number of hours actually worked in total and on each covered contract; deductions made; and actual wages paid.

(3) *Additional records relating to fringe benefits.* Whenever the Secretary of Labor has found under paragraph 1.e. of this section that the wages of any laborer or mechanic include the amount of any costs reasonably anticipated in providing benefits under a plan or program described in [40 U.S.C. 3141\(2\)\(B\)](#) of the Davis-Bacon Act, the contractor must maintain records which show that the commitment to provide such benefits is enforceable, that the plan or program is financially responsible, and that the plan or program has been communicated in writing to the laborers or mechanics affected, and records which show the costs anticipated or the actual cost incurred in providing such benefits.

(4) *Additional records relating to apprenticeship.* Contractors with apprentices working under approved programs must maintain written evidence of the registration of apprenticeship programs, the registration of the apprentices, and the ratios and wage rates prescribed in the applicable programs.

b. *Certified payroll requirements (1) Frequency and method of submission.* The contractor or subcontractor must submit weekly, for each week in which any DBA- or Related Acts-covered work is performed, certified payrolls to the contracting

agency. The prime contractor is responsible for the submission of all certified payrolls by all subcontractors. A contracting agency or prime contractor may permit or require contractors to submit certified payrolls through an electronic system, as long as the electronic system requires a legally valid electronic signature; the system allows the contractor, the contracting agency, and the Department of Labor to access the certified payrolls upon request for at least 3 years after the work on the prime contract has been completed; and the contracting agency or prime contractor permits other methods of submission in situations where the contractor is unable or limited in its ability to use or access the electronic system.

(2) *Information required.* The certified payrolls submitted must set out accurately and completely all of the information required to be maintained under paragraph 3.a.(2) of this section, except that full Social Security numbers and last known addresses, telephone numbers, and email addresses must not be included on weekly transmittals. Instead, the certified payrolls need only include an individually identifying number for each worker (e.g., the last four digits of the worker's Social Security number). The required weekly certified payroll information may be submitted using Optional Form WH-347 or in any other format desired. Optional Form WH-347 is available for this purpose from the Wage and Hour Division website at <https://www.dol.gov/sites/dolgov/files/WHD/legacy/files/wh347.pdf> or its successor website. It is not a violation of this section for a prime contractor to require a subcontractor to provide full Social Security numbers and last known addresses, telephone numbers, and email addresses to the prime contractor for its own records, without weekly submission by the subcontractor to the contracting agency.

(3) *Statement of Compliance.* Each certified payroll submitted must be accompanied by a "Statement of Compliance," signed by the contractor or subcontractor, or the contractor's or subcontractor's agent who pays or supervises the payment of the persons working on the contract, and must certify the following:

(i) That the certified payroll for the payroll period contains the information required to be provided under paragraph 3.b. of this section, the appropriate information and basic records are being maintained under paragraph 3.a. of this section, and such information and records are correct and complete;

(ii) That each laborer or mechanic (including each helper and apprentice) working on the contract during the payroll period has been paid the full weekly wages earned, without rebate, either directly or indirectly, and that no deductions have been made either directly or indirectly from the full wages earned, other than permissible deductions as set forth in [29 CFR part 3](#); and

(iii) That each laborer or mechanic has been paid not less than the applicable wage rates and fringe benefits or cash equivalents for the classification(s) of work actually performed, as specified in the applicable wage determination incorporated into the contract.

(4) *Use of Optional Form WH-347.* The weekly submission of a properly executed certification set forth on the reverse side of Optional Form WH-347 will satisfy the requirement for submission of the "Statement of Compliance" required by paragraph 3.b.(3) of this section.

(5) *Signature.* The signature by the contractor, subcontractor, or the contractor's or subcontractor's agent must be an original handwritten signature or a legally valid electronic signature.

(6) *Falsification.* The falsification of any of the above certifications may subject the contractor or subcontractor to civil or criminal prosecution under [18 U.S.C. 1001](#) and [31 U.S.C. 3729](#).

(7) *Length of certified payroll retention.* The contractor or subcontractor must preserve all certified payrolls during the course of the work and for a period of 3 years after all the work on the prime contract is completed.

c. *Contracts, subcontracts, and related documents.* The contractor or subcontractor must maintain this contract or subcontract and related documents including, without limitation, bids, proposals, amendments, modifications, and extensions. The contractor or subcontractor must preserve these contracts, subcontracts, and related documents during the course of the work and for a period of 3 years after all the work on the prime contract is completed.

d. *Required disclosures and access (1) Required record disclosures and access to workers.* The contractor or subcontractor must make the records required under paragraphs 3.a. through 3.c. of this section, and any other documents that the contracting agency, the State DOT, the FHWA, or the Department of Labor deems necessary to determine compliance with the labor standards provisions of any of the applicable statutes referenced by § 5.1, available for inspection, copying, or transcription by authorized representatives of the contracting agency, the State DOT, the FHWA, or the Department of Labor, and must permit such representatives to interview workers during working hours on the job.

(2) *Sanctions for non-compliance with records and worker access requirements.* If the contractor or subcontractor fails to submit the required records or to make them available, or refuses to permit worker interviews during working hours on the job, the Federal agency may, after written notice to the contractor, sponsor, applicant, owner, or other entity, as the case may be, that maintains such records or that employs such workers, take such action as may be necessary to cause the suspension of any further payment, advance, or guarantee of funds. Furthermore, failure to submit the required records upon request or to make such records available, or to permit worker interviews during working hours on the job, may be grounds for debarment action pursuant to § 5.12. In addition, any contractor or other person that fails to submit the required records or make those records available to WHD within the time WHD requests that the records be produced will be precluded from introducing as evidence in an administrative proceeding under [29 CFR part 6](#) any of the required records that were not provided or made available to WHD. WHD will take into consideration a reasonable request from the contractor or person for an extension of the time for submission of records. WHD will determine the reasonableness of the request and may consider, among other things, the location of the records and the volume of production.

(3) *Required information disclosures.* Contractors and subcontractors must maintain the full Social Security number and last known address, telephone number, and email address

of each covered worker, and must provide them upon request to the contracting agency, the State DOT, the FHWA, the contractor, or the Wage and Hour Division of the Department of Labor for purposes of an investigation or other compliance action.

4. Apprentices and equal employment opportunity (29 CFR 5.5)

a. *Apprentices (1) Rate of pay.* Apprentices will be permitted to work at less than the predetermined rate for the work they perform when they are employed pursuant to and individually registered in a bona fide apprenticeship program registered with the U.S. Department of Labor, Employment and Training Administration, Office of Apprenticeship (OA), or with a State Apprenticeship Agency recognized by the OA. A person who is not individually registered in the program, but who has been certified by the OA or a State Apprenticeship Agency (where appropriate) to be eligible for probationary employment as an apprentice, will be permitted to work at less than the predetermined rate for the work they perform in the first 90 days of probationary employment as an apprentice in such a program. In the event the OA or a State Apprenticeship Agency recognized by the OA withdraws approval of an apprenticeship program, the contractor will no longer be permitted to use apprentices at less than the applicable predetermined rate for the work performed until an acceptable program is approved.

(2) *Fringe benefits.* Apprentices must be paid fringe benefits in accordance with the provisions of the apprenticeship program. If the apprenticeship program does not specify fringe benefits, apprentices must be paid the full amount of fringe benefits listed on the wage determination for the applicable classification. If the Administrator determines that a different practice prevails for the applicable apprentice classification, fringe benefits must be paid in accordance with that determination.

(3) *Apprenticeship ratio.* The allowable ratio of apprentices to journeyworkers on the job site in any craft classification must not be greater than the ratio permitted to the contractor as to the entire work force under the registered program or the ratio applicable to the locality of the project pursuant to paragraph 4.a.(4) of this section. Any worker listed on a payroll at an apprentice wage rate, who is not registered or otherwise employed as stated in paragraph 4.a.(1) of this section, must be paid not less than the applicable wage rate on the wage determination for the classification of work actually performed. In addition, any apprentice performing work on the job site in excess of the ratio permitted under this section must be paid not less than the applicable wage rate on the wage determination for the work actually performed.

(4) *Reciprocity of ratios and wage rates.* Where a contractor is performing construction on a project in a locality other than the locality in which its program is registered, the ratios and wage rates (expressed in percentages of the journeyworker's hourly rate) applicable within the locality in which the construction is being performed must be observed. If there is no applicable ratio or wage rate for the locality of the project, the ratio and wage rate specified in the contractor's registered program must be observed.

b. *Equal employment opportunity.* The use of apprentices and journeyworkers under this part must be in conformity with

the equal employment opportunity requirements of Executive Order 11246, as amended, and [29 CFR part 30](#).

c. Apprentices and Trainees (programs of the U.S. DOT).

Apprentices and trainees working under apprenticeship and skill training programs which have been certified by the Secretary of Transportation as promoting EEO in connection with Federal-aid highway construction programs are not subject to the requirements of paragraph 4 of this Section IV. 23 CFR 230.111(e)(2). The straight time hourly wage rates for apprentices and trainees under such programs will be established by the particular programs. The ratio of apprentices and trainees to journeyworkers shall not be greater than permitted by the terms of the particular program.

5. Compliance with Copeland Act requirements. The contractor shall comply with the requirements of 29 CFR part 3, which are incorporated by reference in this contract as provided in 29 CFR 5.5.

6. Subcontracts. The contractor or subcontractor must insert FHWA-1273 in any subcontracts, along with the applicable wage determination(s) and such other clauses or contract modifications as the contracting agency may by appropriate instructions require, and a clause requiring the subcontractors to include these clauses and wage determination(s) in any lower tier subcontracts. The prime contractor is responsible for the compliance by any subcontractor or lower tier subcontractor with all the contract clauses in this section. In the event of any violations of these clauses, the prime contractor and any subcontractor(s) responsible will be liable for any unpaid wages and monetary relief, including interest from the date of the underpayment or loss, due to any workers of lower-tier subcontractors, and may be subject to debarment, as appropriate. 29 CFR 5.5.

7. Contract termination: debarment. A breach of the contract clauses in 29 CFR 5.5 may be grounds for termination of the contract, and for debarment as a contractor and a subcontractor as provided in 29 CFR 5.12.

8. Compliance with Davis-Bacon and Related Act requirements. All rulings and interpretations of the Davis-Bacon and Related Acts contained in 29 CFR parts 1, 3, and 5 are herein incorporated by reference in this contract as provided in 29 CFR 5.5.

9. Disputes concerning labor standards. As provided in 29 CFR 5.5, disputes arising out of the labor standards provisions of this contract shall not be subject to the general disputes clause of this contract. Such disputes shall be resolved in accordance with the procedures of the Department of Labor set forth in 29 CFR parts 5, 6, and 7. Disputes within the meaning of this clause include disputes between the contractor (or any of its subcontractors) and the contracting agency, the U.S. Department of Labor, or the employees or their representatives.

10. Certification of eligibility. a. By entering into this contract, the contractor certifies that neither it nor any person or firm who has an interest in the contractor's firm is a person or firm ineligible to be awarded Government contracts by virtue of [40 U.S.C. 3144\(b\)](#) or § 5.12(a).

b. No part of this contract shall be subcontracted to any person or firm ineligible for award of a Government contract by virtue of [40 U.S.C. 3144\(b\)](#) or § 5.12(a).

c. The penalty for making false statements is prescribed in the U.S. Code, Title 18 Crimes and Criminal Procedure, [18 U.S.C. 1001](#).

11. Anti-retaliation. It is unlawful for any person to discharge, demote, intimidate, threaten, restrain, coerce, blacklist, harass, or in any other manner discriminate against, or to cause any person to discharge, demote, intimidate, threaten, restrain, coerce, blacklist, harass, or in any other manner discriminate against, any worker or job applicant for:

a. Notifying any contractor of any conduct which the worker reasonably believes constitutes a violation of the DBA, Related Acts, this part, or [29 CFR part 1](#) or [3](#);

b. Filing any complaint, initiating or causing to be initiated any proceeding, or otherwise asserting or seeking to assert on behalf of themselves or others any right or protection under the DBA, Related Acts, this part, or [29 CFR part 1](#) or [3](#);

c. Cooperating in any investigation or other compliance action, or testifying in any proceeding under the DBA, Related Acts, this part, or [29 CFR part 1](#) or [3](#); or

d. Informing any other person about their rights under the DBA, Related Acts, this part, or [29 CFR part 1](#) or [3](#).

V. CONTRACT WORK HOURS AND SAFETY STANDARDS ACT

Pursuant to 29 CFR 5.5(b), the following clauses apply to any Federal-aid construction contract in an amount in excess of \$100,000 and subject to the overtime provisions of the Contract Work Hours and Safety Standards Act. These clauses shall be inserted in addition to the clauses required by 29 CFR 5.5(a) or 29 CFR 4.6. As used in this paragraph, the terms laborers and mechanics include watchpersons and guards.

1. Overtime requirements. No contractor or subcontractor contracting for any part of the contract work which may require or involve the employment of laborers or mechanics shall require or permit any such laborer or mechanic in any workweek in which he or she is employed on such work to work in excess of forty hours in such workweek unless such laborer or mechanic receives compensation at a rate not less than one and one-half times the basic rate of pay for all hours worked in excess of forty hours in such workweek. 29 CFR 5.5.

2. Violation; liability for unpaid wages; liquidated damages. In the event of any violation of the clause set forth in paragraph 1. of this section the contractor and any subcontractor responsible therefor shall be liable for the unpaid wages and interest from the date of the underpayment. In addition, such contractor and subcontractor shall be liable to the United States (in the case of work done under contract for the District of Columbia or a territory, to such District or to such territory), for liquidated damages. Such liquidated damages shall be computed with respect to each individual laborer or

mechanic, including watchpersons and guards, employed in violation of the clause set forth in paragraph 1. of this section, in the sum currently provided in 29 CFR 5.5(b)(2)* for each calendar day on which such individual was required or permitted to work in excess of the standard workweek of forty hours without payment of the overtime wages required by the clause set forth in paragraph 1. of this section.

* \$31 as of January 15, 2023 (See 88 FR 88 FR 2210) as may be adjusted annually by the Department of Labor, pursuant to the Federal Civil Penalties Inflation Adjustment Act of 1990.

3. Withholding for unpaid wages and liquidated damages

a. *Withholding process.* The FHWA or the contracting agency may, upon its own action, or must, upon written request of an authorized representative of the Department of Labor, withhold or cause to be withheld from the contractor so much of the accrued payments or advances as may be considered necessary to satisfy the liabilities of the prime contractor or any subcontractor for any unpaid wages; monetary relief, including interest; and liquidated damages required by the clauses set forth in this section on this contract, any other Federal contract with the same prime contractor, or any other federally assisted contract subject to the Contract Work Hours and Safety Standards Act that is held by the same prime contractor (as defined in § 5.2). The necessary funds may be withheld from the contractor under this contract, any other Federal contract with the same prime contractor, or any other federally assisted contract that is subject to the Contract Work Hours and Safety Standards Act and is held by the same prime contractor, regardless of whether the other contract was awarded or assisted by the same agency, and such funds may be used to satisfy the contractor liability for which the funds were withheld.

b. *Priority to withheld funds.* The Department has priority to funds withheld or to be withheld in accordance with Section IV paragraph 2.a. or paragraph 3.a. of this section, or both, over claims to those funds by:

- (1) A contractor's surety(ies), including without limitation performance bond sureties and payment bond sureties;
- (2) A contracting agency for its procurement costs;
- (3) A trustee(s) (either a court-appointed trustee or a U.S. trustee, or both) in bankruptcy of a contractor, or a contractor's bankruptcy estate;
- (4) A contractor's assignee(s);
- (5) A contractor's successor(s); or
- (6) A claim asserted under the Prompt Payment Act, [31 U.S.C. 3901](#)–3907.

4. Subcontracts. The contractor or subcontractor must insert in any subcontracts the clauses set forth in paragraphs 1. through 5. of this section and a clause requiring the subcontractors to include these clauses in any lower tier subcontracts. The prime contractor is responsible for compliance by any subcontractor or lower tier subcontractor with the clauses set forth in paragraphs 1. through 5. In the

event of any violations of these clauses, the prime contractor and any subcontractor(s) responsible will be liable for any unpaid wages and monetary relief, including interest from the date of the underpayment or loss, due to any workers of lower-tier subcontractors, and associated liquidated damages and may be subject to debarment, as appropriate.

5. Anti-retaliation. It is unlawful for any person to discharge, demote, intimidate, threaten, restrain, coerce, blacklist, harass, or in any other manner discriminate against, or to cause any person to discharge, demote, intimidate, threaten, restrain, coerce, blacklist, harass, or in any other manner discriminate against, any worker or job applicant for:

a. Notifying any contractor of any conduct which the worker reasonably believes constitutes a violation of the Contract Work Hours and Safety Standards Act (CWHSSA) or its implementing regulations in this part;

b. Filing any complaint, initiating or causing to be initiated any proceeding, or otherwise asserting or seeking to assert on behalf of themselves or others any right or protection under CWHSSA or this part;

c. Cooperating in any investigation or other compliance action, or testifying in any proceeding under CWHSSA or this part; or

d. Informing any other person about their rights under CWHSSA or this part.

VI. SUBLETTING OR ASSIGNING THE CONTRACT

This provision is applicable to all Federal-aid construction contracts on the National Highway System pursuant to 23 CFR 635.116.

1. The contractor shall perform with its own organization contract work amounting to not less than 30 percent (or a greater percentage if specified elsewhere in the contract) of the total original contract price, excluding any specialty items designated by the contracting agency. Specialty items may be performed by subcontract and the amount of any such specialty items performed may be deducted from the total original contract price before computing the amount of work required to be performed by the contractor's own organization (23 CFR 635.116).

a. The term "perform work with its own organization" in paragraph 1 of Section VI refers to workers employed or leased by the prime contractor, and equipment owned or rented by the prime contractor, with or without operators. Such term does not include employees or equipment of a subcontractor or lower tier subcontractor, agents of the prime contractor, or any other assignees. The term may include payments for the costs of hiring leased employees from an employee leasing firm meeting all relevant Federal and State regulatory requirements. Leased employees may only be included in this term if the prime contractor meets all of the following conditions: (based on longstanding interpretation)

- (1) the prime contractor maintains control over the supervision of the day-to-day activities of the leased employees;
- (2) the prime contractor remains responsible for the quality of the work of the leased employees;

- (3) the prime contractor retains all power to accept or exclude individual employees from work on the project; and
- (4) the prime contractor remains ultimately responsible for the payment of predetermined minimum wages, the submission of payrolls, statements of compliance and all other Federal regulatory requirements.

b. "Specialty Items" shall be construed to be limited to work that requires highly specialized knowledge, abilities, or equipment not ordinarily available in the type of contracting organizations qualified and expected to bid or propose on the contract as a whole and in general are to be limited to minor components of the overall contract. 23 CFR 635.102.

2. Pursuant to 23 CFR 635.116(a), the contract amount upon which the requirements set forth in paragraph (1) of Section VI is computed includes the cost of material and manufactured products which are to be purchased or produced by the contractor under the contract provisions.

3. Pursuant to 23 CFR 635.116(c), the contractor shall furnish (a) a competent superintendent or supervisor who is employed by the firm, has full authority to direct performance of the work in accordance with the contract requirements, and is in charge of all construction operations (regardless of who performs the work) and (b) such other of its own organizational resources (supervision, management, and engineering services) as the contracting officer determines is necessary to assure the performance of the contract.

4. No portion of the contract shall be sublet, assigned or otherwise disposed of except with the written consent of the contracting officer, or authorized representative, and such consent when given shall not be construed to relieve the contractor of any responsibility for the fulfillment of the contract. Written consent will be given only after the contracting agency has assured that each subcontract is evidenced in writing and that it contains all pertinent provisions and requirements of the prime contract. (based on long-standing interpretation of 23 CFR 635.116).

5. The 30-percent self-performance requirement of paragraph (1) is not applicable to design-build contracts; however, contracting agencies may establish their own self-performance requirements. 23 CFR 635.116(d).

VII. SAFETY: ACCIDENT PREVENTION

This provision is applicable to all Federal-aid construction contracts and to all related subcontracts.

1. In the performance of this contract the contractor shall comply with all applicable Federal, State, and local laws governing safety, health, and sanitation (23 CFR Part 635). The contractor shall provide all safeguards, safety devices and protective equipment and take any other needed actions as it determines, or as the contracting officer may determine, to be reasonably necessary to protect the life and health of employees on the job and the safety of the public and to protect property in connection with the performance of the work covered by the contract. 23 CFR 635.108.

2. It is a condition of this contract, and shall be made a condition of each subcontract, which the contractor enters into pursuant to this contract, that the contractor and any subcontractor shall not permit any employee, in performance of the contract, to work in surroundings or under conditions which are unsanitary, hazardous or dangerous to his/her health or safety, as determined under construction safety and

health standards (29 CFR Part 1926) promulgated by the Secretary of Labor, in accordance with Section 107 of the Contract Work Hours and Safety Standards Act (40 U.S.C. 3704). 29 CFR 1926.10.

3. Pursuant to 29 CFR 1926.3, it is a condition of this contract that the Secretary of Labor or authorized representative thereof, shall have right of entry to any site of contract performance to inspect or investigate the matter of compliance with the construction safety and health standards and to carry out the duties of the Secretary under Section 107 of the Contract Work Hours and Safety Standards Act (40 U.S.C. 3704).

VIII. FALSE STATEMENTS CONCERNING HIGHWAY PROJECTS

This provision is applicable to all Federal-aid construction contracts and to all related subcontracts.

In order to assure high quality and durable construction in conformity with approved plans and specifications and a high degree of reliability on statements and representations made by engineers, contractors, suppliers, and workers on Federal-aid highway projects, it is essential that all persons concerned with the project perform their functions as carefully, thoroughly, and honestly as possible. Willful falsification, distortion, or misrepresentation with respect to any facts related to the project is a violation of Federal law. To prevent any misunderstanding regarding the seriousness of these and similar acts, Form FHWA-1022 shall be posted on each Federal-aid highway project (23 CFR Part 635) in one or more places where it is readily available to all persons concerned with the project:

18 U.S.C. 1020 reads as follows:

"Whoever, being an officer, agent, or employee of the United States, or of any State or Territory, or whoever, whether a person, association, firm, or corporation, knowingly makes any false statement, false representation, or false report as to the character, quality, quantity, or cost of the material used or to be used, or the quantity or quality of the work performed or to be performed, or the cost thereof in connection with the submission of plans, maps, specifications, contracts, or costs of construction on any highway or related project submitted for approval to the Secretary of Transportation; or

Whoever knowingly makes any false statement, false representation, false report or false claim with respect to the character, quality, quantity, or cost of any work performed or to be performed, or materials furnished or to be furnished, in connection with the construction of any highway or related project approved by the Secretary of Transportation; or

Whoever knowingly makes any false statement or false representation as to material fact in any statement, certificate, or report submitted pursuant to provisions of the Federal-aid Roads Act approved July 11, 1916, (39 Stat. 355), as amended and supplemented;

Shall be fined under this title or imprisoned not more than 5 years or both."

IX. IMPLEMENTATION OF CLEAN AIR ACT AND FEDERAL WATER POLLUTION CONTROL ACT (42 U.S.C. 7606; 2 CFR 200.88; EO 11738)

This provision is applicable to all Federal-aid construction contracts in excess of \$150,000 and to all related subcontracts. 48 CFR 2.101; 2 CFR 200.327.

By submission of this bid/proposal or the execution of this contract or subcontract, as appropriate, the bidder, proposer, Federal-aid construction contractor, subcontractor, supplier, or vendor agrees to comply with all applicable standards, orders or regulations issued pursuant to the Clean Air Act (42 U.S.C. 7401-7671q) and the Federal Water Pollution Control Act, as amended (33 U.S.C. 1251-1387). Violations must be reported to the Federal Highway Administration and the Regional Office of the Environmental Protection Agency. 2 CFR Part 200, Appendix II.

The contractor agrees to include or cause to be included the requirements of this Section in every subcontract, and further agrees to take such action as the contracting agency may direct as a means of enforcing such requirements. 2 CFR 200.327.

X. CERTIFICATION REGARDING DEBARMENT, SUSPENSION, INELIGIBILITY AND VOLUNTARY EXCLUSION

This provision is applicable to all Federal-aid construction contracts, design-build contracts, subcontracts, lower-tier subcontracts, purchase orders, lease agreements, consultant contracts or any other covered transaction requiring FHWA approval or that is estimated to cost \$25,000 or more – as defined in 2 CFR Parts 180 and 1200. 2 CFR 180.220 and 1200.220.

1. Instructions for Certification – First Tier Participants:

- a. By signing and submitting this proposal, the prospective first tier participant is providing the certification set out below.
- b. The inability of a person to provide the certification set out below will not necessarily result in denial of participation in this covered transaction. The prospective first tier participant shall submit an explanation of why it cannot provide the certification set out below. The certification or explanation will be considered in connection with the department or agency's determination whether to enter into this transaction. However, failure of the prospective first tier participant to furnish a certification or an explanation shall disqualify such a person from participation in this transaction. 2 CFR 180.320.
- c. The certification in this clause is a material representation of fact upon which reliance was placed when the contracting agency determined to enter into this transaction. If it is later determined that the prospective participant knowingly rendered an erroneous certification, in addition to other remedies available to the Federal Government, the contracting agency may terminate this transaction for cause of default. 2 CFR 180.325.
- d. The prospective first tier participant shall provide immediate written notice to the contracting agency to whom this proposal is submitted if any time the prospective first tier participant learns that its certification was erroneous when submitted or has become erroneous by reason of changed circumstances. 2 CFR 180.345 and 180.350.

e. The terms "covered transaction," "debarred," "suspended," "ineligible," "participant," "person," "principal," and "voluntarily excluded," as used in this clause, are defined in 2 CFR Parts 180, Subpart I, 180.900-180.1020, and 1200. "First Tier Covered Transactions" refers to any covered transaction between a recipient or subrecipient of Federal funds and a participant (such as the prime or general contract). "Lower Tier Covered Transactions" refers to any covered transaction under a First Tier Covered Transaction (such as subcontracts). "First Tier Participant" refers to the participant who has entered into a covered transaction with a recipient or subrecipient of Federal funds (such as the prime or general contractor). "Lower Tier Participant" refers any participant who has entered into a covered transaction with a First Tier Participant or other Lower Tier Participants (such as subcontractors and suppliers).

f. The prospective first tier participant agrees by submitting this proposal that, should the proposed covered transaction be entered into, it shall not knowingly enter into any lower tier covered transaction with a person who is debarred, suspended, declared ineligible, or voluntarily excluded from participation in this covered transaction, unless authorized by the department or agency entering into this transaction. 2 CFR 180.330.

g. The prospective first tier participant further agrees by submitting this proposal that it will include the clause titled "Certification Regarding Debarment, Suspension, Ineligibility and Voluntary Exclusion-Lower Tier Covered Transactions," provided by the department or contracting agency, entering into this covered transaction, without modification, in all lower tier covered transactions and in all solicitations for lower tier covered transactions exceeding the \$25,000 threshold. 2 CFR 180.220 and 180.300.

h. A participant in a covered transaction may rely upon a certification of a prospective participant in a lower tier covered transaction that is not debarred, suspended, ineligible, or voluntarily excluded from the covered transaction, unless it knows that the certification is erroneous. 2 CFR 180.300; 180.320, and 180.325. A participant is responsible for ensuring that its principals are not suspended, debarred, or otherwise ineligible to participate in covered transactions. 2 CFR 180.335. To verify the eligibility of its principals, as well as the eligibility of any lower tier prospective participants, each participant may, but is not required to, check the System for Award Management website (<https://www.sam.gov/>). 2 CFR 180.300, 180.320, and 180.325.

i. Nothing contained in the foregoing shall be construed to require the establishment of a system of records in order to render in good faith the certification required by this clause. The knowledge and information of the prospective participant is not required to exceed that which is normally possessed by a prudent person in the ordinary course of business dealings.

j. Except for transactions authorized under paragraph (f) of these instructions, if a participant in a covered transaction knowingly enters into a lower tier covered transaction with a person who is suspended, debarred, ineligible, or voluntarily excluded from participation in this transaction, in addition to other remedies available to the Federal Government, the department or agency may terminate this transaction for cause or default. 2 CFR 180.325.

2. Certification Regarding Debarment, Suspension, Ineligibility and Voluntary Exclusion – First Tier Participants:

a. The prospective first tier participant certifies to the best of its knowledge and belief, that it and its principals:

(1) Are not presently debarred, suspended, proposed for debarment, declared ineligible, or voluntarily excluded from participating in covered transactions by any Federal department or agency, 2 CFR 180.335;

(2) Have not within a three-year period preceding this proposal been convicted of or had a civil judgment rendered against them for commission of fraud or a criminal offense in connection with obtaining, attempting to obtain, or performing a public (Federal, State, or local) transaction or contract under a public transaction; violation of Federal or State antitrust statutes or commission of embezzlement, theft, forgery, bribery, falsification or destruction of records, making false statements, or receiving stolen property, 2 CFR 180.800;

(3) Are not presently indicted for or otherwise criminally or civilly charged by a governmental entity (Federal, State or local) with commission of any of the offenses enumerated in paragraph (a)(2) of this certification, 2 CFR 180.700 and 180.800; and

(4) Have not within a three-year period preceding this application/proposal had one or more public transactions (Federal, State or local) terminated for cause or default. 2 CFR 180.335(d).

(5) Are not a corporation that has been convicted of a felony violation under any Federal law within the two-year period preceding this proposal (USDOT Order 4200.6 implementing appropriations act requirements); and

(6) Are not a corporation with any unpaid Federal tax liability that has been assessed, for which all judicial and administrative remedies have been exhausted, or have lapsed, and that is not being paid in a timely manner pursuant to an agreement with the authority responsible for collecting the tax liability (USDOT Order 4200.6 implementing appropriations act requirements).

b. Where the prospective participant is unable to certify to any of the statements in this certification, such prospective participant should attach an explanation to this proposal. 2 CFR 180.335 and 180.340.

3. Instructions for Certification - Lower Tier Participants:

(Applicable to all subcontracts, purchase orders, and other lower tier transactions requiring prior FHWA approval or estimated to cost \$25,000 or more - 2 CFR Parts 180 and 1200). 2 CFR 180.220 and 1200.220.

a. By signing and submitting this proposal, the prospective lower tier participant is providing the certification set out below.

b. The certification in this clause is a material representation of fact upon which reliance was placed when this transaction was entered into. If it is later determined that the prospective lower tier participant knowingly rendered an erroneous certification, in addition to other remedies available to the Federal Government, the department, or agency with which

this transaction originated may pursue available remedies, including suspension and/or debarment.

c. The prospective lower tier participant shall provide immediate written notice to the person to which this proposal is submitted if at any time the prospective lower tier participant learns that its certification was erroneous by reason of changed circumstances. 2 CFR 180.365.

d. The terms "covered transaction," "debarred," "suspended," "ineligible," "participant," "person," "principal," and "voluntarily excluded," as used in this clause, are defined in 2 CFR Parts 180, Subpart I, 180.900 – 180.1020, and 1200. You may contact the person to which this proposal is submitted for assistance in obtaining a copy of those regulations. "First Tier Covered Transactions" refers to any covered transaction between a recipient or subrecipient of Federal funds and a participant (such as the prime or general contract). "Lower Tier Covered Transactions" refers to any covered transaction under a First Tier Covered Transaction (such as subcontracts). "First Tier Participant" refers to the participant who has entered into a covered transaction with a recipient or subrecipient of Federal funds (such as the prime or general contractor). "Lower Tier Participant" refers any participant who has entered into a covered transaction with a First Tier Participant or other Lower Tier Participants (such as subcontractors and suppliers).

e. The prospective lower tier participant agrees by submitting this proposal that, should the proposed covered transaction be entered into, it shall not knowingly enter into any lower tier covered transaction with a person who is debarred, suspended, declared ineligible, or voluntarily excluded from participation in this covered transaction, unless authorized by the department or agency with which this transaction originated. 2 CFR 1200.220 and 1200.332.

f. The prospective lower tier participant further agrees by submitting this proposal that it will include this clause titled "Certification Regarding Debarment, Suspension, Ineligibility and Voluntary Exclusion-Lower Tier Covered Transaction," without modification, in all lower tier covered transactions and in all solicitations for lower tier covered transactions exceeding the \$25,000 threshold. 2 CFR 180.220 and 1200.220.

g. A participant in a covered transaction may rely upon a certification of a prospective participant in a lower tier covered transaction that is not debarred, suspended, ineligible, or voluntarily excluded from the covered transaction, unless it knows that the certification is erroneous. A participant is responsible for ensuring that its principals are not suspended, debarred, or otherwise ineligible to participate in covered transactions. To verify the eligibility of its principals, as well as the eligibility of any lower tier prospective participants, each participant may, but is not required to, check the System for Award Management website (<https://www.sam.gov/>), which is compiled by the General Services Administration. 2 CFR 180.300, 180.320, 180.330, and 180.335.

h. Nothing contained in the foregoing shall be construed to require establishment of a system of records in order to render in good faith the certification required by this clause. The knowledge and information of participant is not required to exceed that which is normally possessed by a prudent person in the ordinary course of business dealings.

i. Except for transactions authorized under paragraph e of these instructions, if a participant in a covered transaction knowingly enters into a lower tier covered transaction with a person who is suspended, debarred, ineligible, or voluntarily

excluded from participation in this transaction, in addition to other remedies available to the Federal Government, the department or agency with which this transaction originated may pursue available remedies, including suspension and/or debarment. 2 CFR 180.325.

* * * * *

4. Certification Regarding Debarment, Suspension, Ineligibility and Voluntary Exclusion--Lower Tier Participants:

a. The prospective lower tier participant certifies, by submission of this proposal, that neither it nor its principals:

(1) is presently debarred, suspended, proposed for debarment, declared ineligible, or voluntarily excluded from participating in covered transactions by any Federal department or agency, 2 CFR 180.355;

(2) is a corporation that has been convicted of a felony violation under any Federal law within the two-year period preceding this proposal (USDOT Order 4200.6 implementing appropriations act requirements); and

(3) is a corporation with any unpaid Federal tax liability that has been assessed, for which all judicial and administrative remedies have been exhausted, or have lapsed, and that is not being paid in a timely manner pursuant to an agreement with the authority responsible for collecting the tax liability. (USDOT Order 4200.6 implementing appropriations act requirements)

b. Where the prospective lower tier participant is unable to certify to any of the statements in this certification, such prospective participant should attach an explanation to this proposal.

* * * * *

XI. CERTIFICATION REGARDING USE OF CONTRACT FUNDS FOR LOBBYING

This provision is applicable to all Federal-aid construction contracts and to all related subcontracts which exceed \$100,000. 49 CFR Part 20, App. A.

1. The prospective participant certifies, by signing and submitting this bid or proposal, to the best of his or her knowledge and belief, that:

a. No Federal appropriated funds have been paid or will be paid, by or on behalf of the undersigned, to any person for influencing or attempting to influence an officer or employee of any Federal agency, a Member of Congress, an officer or employee of Congress, or an employee of a Member of Congress in connection with the awarding of any Federal contract, the making of any Federal grant, the making of any Federal loan, the entering into of any cooperative agreement, and the extension, continuation, renewal, amendment, or modification of any Federal contract, grant, loan, or cooperative agreement.

b. If any funds other than Federal appropriated funds have been paid or will be paid to any person for influencing or attempting to influence an officer or employee of any Federal agency, a Member of Congress, an officer or employee of Congress, or an employee of a Member of Congress in connection with this Federal contract, grant, loan, or

cooperative agreement, the undersigned shall complete and submit Standard Form-LLL, "Disclosure Form to Report Lobbying," in accordance with its instructions.

2. This certification is a material representation of fact upon which reliance was placed when this transaction was made or entered into. Submission of this certification is a prerequisite for making or entering into this transaction imposed by 31 U.S.C. 1352. Any person who fails to file the required certification shall be subject to a civil penalty of not less than \$10,000 and not more than \$100,000 for each such failure.

3. The prospective participant also agrees by submitting its bid or proposal that the participant shall require that the language of this certification be included in all lower tier subcontracts, which exceed \$100,000 and that all such recipients shall certify and disclose accordingly.

XII. USE OF UNITED STATES-FLAG VESSELS:

This provision is applicable to all Federal-aid construction contracts, design-build contracts, subcontracts, lower-tier subcontracts, purchase orders, lease agreements, or any other covered transaction. 46 CFR Part 381.

This requirement applies to material or equipment that is acquired for a specific Federal-aid highway project. 46 CFR 381.7. It is not applicable to goods or materials that come into inventories independent of an FHWA funded-contract.

When oceanic shipments (or shipments across the Great Lakes) are necessary for materials or equipment acquired for a specific Federal-aid construction project, the bidder, proposer, contractor, subcontractor, or vendor agrees:

1. To utilize privately owned United States-flag commercial vessels to ship at least 50 percent of the gross tonnage (computed separately for dry bulk carriers, dry cargo liners, and tankers) involved, whenever shipping any equipment, material, or commodities pursuant to this contract, to the extent such vessels are available at fair and reasonable rates for United States-flag commercial vessels. 46 CFR 381.7.

2. To furnish within 20 days following the date of loading for shipments originating within the United States or within 30 working days following the date of loading for shipments originating outside the United States, a legible copy of a rated, 'on-board' commercial ocean bill-of-lading in English for each shipment of cargo described in paragraph (b)(1) of this section to both the Contracting Officer (through the prime contractor in the case of subcontractor bills-of-lading) and to the Office of Cargo and Commercial Sealift (MAR-620), Maritime Administration, Washington, DC 20590. (MARAD requires copies of the ocean carrier's (master) bills of lading, certified onboard, dated, with rates and charges. These bills of lading may contain business sensitive information and therefore may be submitted directly to MARAD by the Ocean Transportation Intermediary on behalf of the contractor). 46 CFR 381.7.

**ATTACHMENT A - EMPLOYMENT AND MATERIALS
PREFERENCE FOR APPALACHIAN DEVELOPMENT
HIGHWAY SYSTEM OR APPALACHIAN LOCAL ACCESS
ROAD CONTRACTS (23 CFR 633, Subpart B, Appendix B)**

This provision is applicable to all Federal-aid projects funded under the Appalachian Regional Development Act of 1965.

1. During the performance of this contract, the contractor undertaking to do work which is, or reasonably may be, done as on-site work, shall give preference to qualified persons who regularly reside in the labor area as designated by the DOL wherein the contract work is situated, or the subregion, or the Appalachian counties of the State wherein the contract work is situated, except:

a. To the extent that qualified persons regularly residing in the area are not available.

b. For the reasonable needs of the contractor to employ supervisory or specially experienced personnel necessary to assure an efficient execution of the contract work.

c. For the obligation of the contractor to offer employment to present or former employees as the result of a lawful collective bargaining contract, provided that the number of nonresident persons employed under this subparagraph (1c) shall not exceed 20 percent of the total number of employees employed by the contractor on the contract work, except as provided in subparagraph (4) below.

2. The contractor shall place a job order with the State Employment Service indicating (a) the classifications of the laborers, mechanics and other employees required to perform the contract work, (b) the number of employees required in each classification, (c) the date on which the participant estimates such employees will be required, and (d) any other pertinent information required by the State Employment Service to complete the job order form. The job order may be placed with the State Employment Service in writing or by telephone. If during the course of the contract work, the information submitted by the contractor in the original job order is substantially modified, the participant shall promptly notify the State Employment Service.

3. The contractor shall give full consideration to all qualified job applicants referred to him by the State Employment Service. The contractor is not required to grant employment to any job applicants who, in his opinion, are not qualified to perform the classification of work required.

4. If, within one week following the placing of a job order by the contractor with the State Employment Service, the State Employment Service is unable to refer any qualified job applicants to the contractor, or less than the number requested, the State Employment Service will forward a certificate to the contractor indicating the unavailability of applicants. Such certificate shall be made a part of the contractor's permanent project records. Upon receipt of this certificate, the contractor may employ persons who do not normally reside in the labor area to fill positions covered by the certificate, notwithstanding the provisions of subparagraph (1c) above.

5. The provisions of 23 CFR 633.207(e) allow the contracting agency to provide a contractual preference for the use of mineral resource materials native to the Appalachian region.

6. The contractor shall include the provisions of Sections 1 through 4 of this Attachment A in every subcontract for work which is, or reasonably may be, done as on-site work.

ARKANSAS DEPARTMENT OF TRANSPORTATION

SUPPLEMENTAL SPECIFICATION

EQUAL EMPLOYMENT OPPORTUNITY - NOTICE TO CONTRACTORS

Elsewhere in this contract are three Supplemental Specifications on Equal Employment Opportunity designated as PR-1273 Supplements. They are (1) Specific Equal Employment Opportunity Responsibilities (23 U.S.C. 140), (2) Equal Employment Opportunity - Goals and Timetables, and (3) Equal Employment Opportunity - Federal Standards. This notice is to clarify the responsibilities for review of compliance and enforcement for these separate supplemental specification requirements.

The first of the Supplemental Specifications cited above covers the requirements for the equal employment opportunity program under Title 23 for which the Arkansas Department of Transportation (ARDOT) is responsible. The ARDOT performs the necessary compliance review and enforcement of this Supplemental Specification which is applicable to all contractors holding Federal-aid highway contracts.

The latter two Supplemental Specifications are for the specific equal opportunity requirements for Executive Order 11246 which is the sole responsibility of the Office of Federal Contract Compliance Programs (OFCCP), Department of Labor. Review and enforcement under these Supplemental Specifications is performed by OFCCP.

OFCCP has, under Paragraph 8 of the EEO Federal Standards Supplemental Specification, recognized the Arkansas AGC Heavy Highway Affirmative Action Plan as meeting the provisions of that Supplemental Specification and Supplemental Specification (2) cited above. With this recognition, those contractors signatory to the AGC Plan have been waived from individual review by OFCCP. However, OFCCP retains the right to review any such contractors whenever circumstances warrant. Also, contractors non-signatory to the AGC Plan are subject to OFCCP review under EO 11246.

ARDOT and OFCCP have agreed to work towards eliminating duplicative reviews on individual contractors; however, each agency may make reviews at any time notwithstanding the cited agreement.

ARKANSAS DEPARTMENT OF TRANSPORTATION

SPECIAL PROVISION

SPECIFIC EQUAL EMPLOYMENT OPPORTUNITY RESPONSIBILITIES
(23 U.S.C. 140)**1. General.**

a. Equal employment opportunity requirements not to discriminate and to take affirmative action to assure equal employment opportunity as required by Executive Order 11246 and Executive Order 11375 are set forth in Required Contract Provisions (Form FHWA-1273 and Supplements) and these Special Provisions which are imposed pursuant to Section 140 of Title 23, U.S.C., as established by Section 22 of the Federal-Aid Highway Act of 1968. The requirements set forth in these Special Provisions shall constitute the specific affirmative action requirements for project activities under this contract and supplement the equal employment opportunity requirements set forth in the Required Contract Provisions. The initial measure of the contractor's good faith efforts to comply with these Special Provisions shall be its efforts to meet the goals set forth in the "Notice of Requirement for Affirmative Action to Ensure Equal Employment Opportunity (Executive Order 11246)" for minority and female participation expressed in percentage terms for the contractor's work force in each trade on this project.

b. The contractor will work with the Department and the Federal Government in carrying out equal employment opportunity obligations and in their review of his/her activities under the contract.

c. The contractor and all his/her subcontractors holding subcontracts not including material suppliers, of \$10,000 or more, will comply with the following minimum specific requirement activities of equal employment opportunity: (The equal employment opportunity requirements of Executive Order 11246, as set forth in Volume 6, Chapter 4, Section 1, Subsection 1 of the Federal-Aid Highway Program Manual, are applicable to material suppliers as well as contractors and subcontractors.) The contractor will include these requirements in every subcontract of \$10,000 or more with such modification of language as is necessary to make them binding on the subcontractor.

2. Equal Employment Opportunity Policy.

The contractor will accept as his operating policy the following statement which is designed to further the provision of equal employment opportunity to all persons without regard to their race, color, religion, sex, age, disability, or national origin, and to promote the full realization of equal employment opportunity through a positive continuing program:

It is the policy of this Company to assure that applicants are employed, and that employees are treated during employment without regard to their race, color, religion, sex, age, disability, or national origin. Such action shall include: employment, upgrading, demotion, or transfer; recruitment or recruitment advertising; layoff or termination; rates of pay or other forms of compensation; and selection for training, including apprenticeship, preapprenticeship, and/or on-the-job training.

3. Equal Employment Opportunity Officer.

The contractor will designate and make known to the Department contracting officers an equal employment opportunity officer (hereinafter referred to as the EEO Officer) who will have the responsibility for and must be capable of effectively administering and promoting an active contractor program of equal employment opportunity and who must be assigned adequate authority and responsibility to do so.

4. Dissemination of Policy.

a. All members of the contractor's staff who are authorized to hire, supervise, promote, and discharge employees, or who recommend such action, or who are substantially involved in such action, will be made fully cognizant of, and will implement, the contractor's equal employment opportunity policy and contractual responsibilities to provide equal employment opportunity in each grade and classification of employment. To ensure that the above agreement will be met, the following actions will be taken as a minimum:

(1) Periodic meetings of supervisory and personnel office employees will be conducted before the start of work and then not less often than once every six months, at which time the contractor's equal employment opportunity policy and its implementation will be reviewed and explained. The meetings will be conducted by the EEO Officer or other knowledgeable company official.

(2) All new supervisory or personnel office employees will be given a thorough indoctrination by the EEO Officer or other knowledgeable company official covering all major aspects of the contractor's equal employment opportunity obligations within thirty days following their reporting for duty with the contractor.

(3) All personnel who are engaged in direct recruitment for the project will be instructed by the EEO Officer or appropriate company official in the contractor's procedures for locating and hiring minority and female employees.

b. In order to make the contractor's equal employment opportunity policy known to all employees, prospective employees and potential sources of employees, i.e., schools, employment agencies, labor unions (where appropriate), college placement officers, etc., the contractor will take the following actions:

(1) Notices and posters setting forth the contractor's equal employment opportunity policy will be placed in areas readily accessible to employees, applicants for employment, and potential employees.

(2) The contractor's equal employment opportunity policy and the procedures to implement such policy will be brought to the attention of employees by means of meetings, employee handbooks, or other appropriate means.

5. Recruitment.

a. When advertising for employees, the contractor will include in all advertisements for employees the notation: "An Equal Opportunity Employer." All such advertisements will be published in newspapers or other publications having a large circulation among minority groups in the area from which the project work force would normally be derived.

b. The contractor will, unless precluded by a valid bargaining agreement, conduct systematic and direct recruitment through public and private employee referral sources likely to yield qualified minority and female applicants, including, but not limited to, State employment agencies, schools, colleges, and minority group organizations. To meet this requirement, the contractor will, through his EEO Officer, identify sources of potential minority and female employees, and establish with such identified sources procedures whereby minority and female applicants may be referred to the contractor for employment consideration.

In the event the contractor has a valid bargaining agreement providing for exclusive hiring hall referrals, he is expected to observe the provisions of that agreement to the extent that the system permits the contractor's compliance with equal employment opportunity contract provisions. (The U.S. Department of Labor has held that where implementation of such agreements has the effect of discriminating against minorities or women, or obligates the contractor to do the same, such implementation violates Executive Order 11246, as amended.)

c. The contractor will encourage his present employees to refer minority and female applicants for employment by posting appropriate notices or bulletins in areas accessible to all such employees. In addition, information and procedures with regard to referring minority and female applicants will be discussed with employees.

6. Personnel Actions.

Wages, working conditions, and employee benefits shall be established and administered, and personnel actions of every type, including hiring, upgrading, promotion, transfer, demotion, layoff, and termination, shall be taken without regard to race, color, religion, sex, age, disability, or national origin. The following procedures shall be followed:

a. The contractor will conduct periodic inspections of project sites to insure that working conditions and employee facilities do not indicate discriminatory treatment of project site personnel

b. The contractor will periodically evaluate the spread of wages paid within each classification to determine any evidence of discriminatory wage practices.

c. The contractor will periodically review selected personnel actions in depth to determine whether there is evidence of discrimination. Where evidence is found, the contractor will promptly take corrective action. If the review indicates that the discrimination may extend beyond the actions reviewed, such corrective action shall include all affected persons.

d. The contractor will promptly investigate all complaints of alleged discrimination made to the contractor in connection with his obligations under this contract, will attempt to resolve such complaints, and will take appropriate corrective action within a reasonable time. If the investigation indicates that the discrimination may affect persons other than the complainant, such corrective action shall include such other persons. Upon completion of each investigation, the contractor will inform every complainant of all of his avenues of appeal.

7. Training and Promotion.

a. The contractor will assist in locating, qualifying, and increasing the skills of minority group and women employees and applicants for employment.

b. Consistent with the contractor's work force requirements and as permissible under Federal and State regulations, the contractor shall make full use of training programs, i.e., apprenticeship and on-the-job training programs for the geographical area of contract performance. Where feasible, 25 percent of apprentices or trainees in each occupation shall be in their first year of apprenticeship or training. In the event the Optional Training Special Provision is provided under this contract, this subparagraph will be superseded by that Special Provision.

c. The contractor will advise employees and applicants for employment of available training programs and entrance requirements for each.

d. The contractor will periodically review the training and promotion potential of minority group and women employees and will encourage eligible employees to apply for such training and promotion.

8. Unions.

If the contractor relies in whole or in part upon unions as a source of employees, the contractor will use his/her best efforts to obtain the cooperation of such unions to increase opportunities for minority groups and women within the unions, and to effect referrals by such unions of minority and female employees. Actions by the contractor either directly or through a contractor's association acting as agent will include the procedures set forth below:

a. The contractor will use best efforts to develop, in cooperation with the unions, joint training programs aimed toward qualifying more minority group members and women for membership in the unions and increasing the skills of minority group employees and women so that they may qualify for higher paying employment.

b. The contractor will use best efforts to incorporate an equal employment opportunity clause into each union agreement to the end that such union will be contractually bound to refer applicants without regard to their race, color, religion, sex, age, disability, or national origin.

c. The contractor is to obtain information as to the referral practices and policies of the labor union, except that to the extent such information is within the exclusive possession of the labor union and such labor union refuses to furnish such information to the contractor, the contractor shall so certify to the State Highway Department and shall set forth what efforts have been made to obtain such information.

d. In the event the union is unable to provide the contractor with a reasonable flow of minority and women referrals within the time limit set forth in the collective bargaining agreement, the contractor will, through independent recruitment efforts, fill the employment vacancies without regard to race, color, religion, sex, age, disability, or national origin, making full efforts to obtain qualified and/or qualifiable minority group persons and women. (The U.S. Department of Labor has held that it shall be no excuse that the union with which the contractor has a collective bargaining agreement providing for exclusive referral failed to refer minority employees.) In the event the union referral practice prevents the contractor from meeting the obligations pursuant to Executive Order 11246, as amended, and these special provisions, such contractor shall immediately notify the Department.

9. Subcontracting.

a. The contractor's attention is called to the Special Provision on Disadvantaged Business Enterprises in Federal-Aid Highway Construction.

b. The contractor will use his best efforts to ensure subcontractor compliance with their equal employment opportunity obligations.

10. Records and Reports.

a. The contractor will keep such records as are necessary to determine compliance with the contractor's equal employment opportunity obligations. The records kept by the contractor will be designed to indicate:

(1) the number of minority and non-minority group members and women employed in each work classification on the project,

(2) the progress and efforts being made in cooperation with unions to increase employment opportunities for minorities and women (applicable only to contractors who rely in whole or in part on unions as a source of their work force),

(3) the progress and efforts being made in locating, hiring, training, qualifying, and upgrading minority and female employees, and

(4) the progress and efforts being made in securing the services of Disadvantaged Business Enterprises or subcontractors or subcontractors with meaningful minority and female representation among their employees.

b. All such records must be retained for a period of three years following completion of the contract work and shall be available at reasonable times and places for inspection by authorized representatives of the Department and the Federal Highway Administration.

c. The contractors will submit an annual report to the State Highway agency each July for the duration of the project, indicating the number of minority, women, and non-minority group employees currently engaged in each work classification required by the contract work. This information is to be reported on Form PR 1391.

11. Corrective Action Plans.

The contractor understands that a designated representative of the Department will periodically review compliance by the contractor with all contractual provisions incorporated pursuant to Executive Order 11246, as amended, and Federal Highway Administration Equal Employment Opportunity Special Provisions implementing the Federal-Aid Highway Act of 1968, where applicable.

In the event that the designated representative of the Department finds that the contractor has failed to comply with any of the aforementioned contractual provisions, he will notify the contractor of this finding in writing. A declaration of default will result in the suspension of all future payments. No declaration of default will be made if the Department and the contractor formally agree to enter into a corrective action plan setting out the specified steps and timetables the contractor will be contractually obligated to perform in order to re-establish his compliance. This corrective action plan, in order to be accepted by the Department, shall include the following mandatory enforcement language:

"If, at any time in the future, the Office of Federal Contract Compliance Programs or the Federal Highway Administration or the Arkansas State Highway Commission or their successor(s) believe that (name of contractor) has violated any portion of this agreement, (name of contractor) shall be promptly notified of the fact in writing. This notification shall include a statement of the facts and circumstances relied upon in forming that belief. In addition, the notification shall provide (name of contractor) with 15 days to respond in writing to the notification except where the Office of Federal Contract Compliance Programs, the Federal Highway Administration or the Arkansas State Highway Commission alleges that such delay would result in irreparable injury. It is understood that enforcement proceedings for violation of this agreement may be initiated at any time after the 15-day period has elapsed (or sooner if irreparable injury is alleged) without issuance of a show cause notice."

"It is recognized that where the Office of Federal Contract Compliance Programs and/or the Federal Highway Administration and/or the Arkansas State Highway Commission believes that (name of contractor) has breached this agreement, evidence regarding the entire scope of (name of contractor) alleged noncompliance from which this agreement resulted, in addition to evidence regarding (name of contractor) alleged violation of this agreement, may be introduced at the enforcement proceeding."

"Violation of this agreement may subject (name of contractor) to sanctions pursuant to the Arkansas State Highway Commission contract administration procedures. It is further recognized that liability for violation of this agreement may also subject (name of contractor) to sanctions set forth in Section 209 of Executive Order 11246, as amended, and/or appropriate relief."

The contractor will submit quarterly reports to the Department as a result of any deficiencies cited during an equal employment opportunity compliance review. The reports will indicate the affirmative action steps taken to correct the deficiencies. Instructions for submission of the reports will be furnished by the Equal Employment Opportunity Section.

ARKANSAS DEPARTMENT OF TRANSPORTATION

SUPPLEMENTAL SPECIFICATION

EQUAL EMPLOYMENT OPPORTUNITY - GOALS AND TIMETABLES

NOTICE OF REQUIREMENT FOR AFFIRMATIVE
ACTION TO ENSURE EQUAL EMPLOYMENT
OPPORTUNITY (EXECUTIVE ORDER 11246)

1. The Bidder's attention is called to the "Equal Opportunity Clause" and the "Standard Federal Equal Employment Specifications" set forth herein.

2. The goals and timetables for minority and female participation, expressed in percentage terms for the Contractor's aggregate workforce in each trade on all construction work in the covered area, are as follows:

MINORITIESCOUNTY

Arkansas	16.4%	Lee	26.5%
Ashley	16.4%	Lincoln	16.4%
Baxter	3.3%	Little River	19.7%
Benton	3.3%	Logan	6.6%
Boone	3.3%	Lonoke	16.4%
Bradley	16.4%	Madison	3.3%
Calhoun	16.4%	Marion	3.3%
Carroll	3.3%	Miller	19.7%
Chicot	16.4%	Mississippi	26.5%
Clark	16.4%	Monroe	16.4%
Clay	26.5%	Montgomery	16.4%
Cleburne	16.4%	Nevada	20.2%
Cleveland	16.4%	Newton	3.3%
Columbia	20.2%	Ouachita	16.4%
Conway	16.4%	Perry	16.4%
Craighead	26.5%	Phillips	26.5%
Crawford	5.6%	Pike	20.2%
Crittenden	32.3%	Poinsett	26.5%
Cross	26.5%	Polk	6.6%
Dallas	16.4%	Pope	16.4%
Desha	16.4%	Präirie	16.4%
Drew	16.4%	Pulaski	15.7%
Faulkner	16.4%	Randolph	26.5%
Franklin	6.6%	Saline	15.7%
Fulton	16.4%	Scott	6.6%
Garland	16.4%	Searcy	3.3%
Grant	16.4%	Sebastian	5.6%
Greene	26.5%	Sevier	20.2%
Hempstead	20.2%	Sharp	16.4%
Hot Spring	16.4%	Stone	16.4%
Howard	20.2%	St. Francis	26.5%
Independence	16.4%	Union	16.4%
Izard	16.4%	Van Buren	16.4%
Jackson	16.4%	Washington	3.3%
Jefferson	31.2%	White	16.4%
Johnson	16.4%	Woodruff	16.4%
Lafayette	20.2%	Yell	16.4%
Lawrence	26.5%		

FEMALES

Statewide - 6.9%

These goals are applicable to all the Contractor's construction work (whether or not it is Federal or federally assisted) performed in the covered area. If the Contractor performs construction work in a geographical area located outside of the covered area, it shall apply the goals established for such geographical area where the work is actually performed. With regard to this second area, the Contractor also is subject to the goals for both its federally involved and nonfederally involved construction.

The Contractor's compliance with the Executive Order and the regulations in 41 CFR Part 60-4 shall be based on its implementation of the Equal Opportunity Clause, specific affirmative action obligations required by the specifications set forth in 41 CFR 60-4.3(a), and its efforts to meet the goals. The hours of minority and female employment and training must be substantially uniform throughout the length of the contract, and in each trade, and the Contractor shall make a good faith effort to employ minorities and women evenly on each of its projects. The transfer of minority or female employees or trainees from Contractor to Contractor or from project to project for the sole purpose of meeting the Contractor's goals shall be a violation of the contract, the Executive Order and the regulations in 41 CFR Part 60-4. Compliance with the goals will be measured against the total work hours performed.

3. The Contractor shall provide written notification to the Director of the Office of Federal Contract Compliance Programs within 10 working days of award of any construction subcontract in excess of \$10,000 at any tier for construction work under the contract resulting from this solicitation. The notification shall list the name, address and telephone number of the subcontractor; employer identification number of the subcontractor; estimated dollar amount of the subcontract; estimated starting and completion dates of the subcontract; and the geographical area in which the subcontract is to be performed.

4. As used in this Notice, and in the contract resulting from this solicitation, the "covered area" is as described in the Proposal Form for this report.

ARKANSAS DEPARTMENT OF TRANSPORTATION

SUPPLEMENTAL SPECIFICATION

EQUAL EMPLOYMENT OPPORTUNITY - FEDERAL STANDARDS

STANDARD FEDERAL EQUAL EMPLOYMENT OPPORTUNITY
CONSTRUCTION CONTRACT SPECIFICATIONS
(EXECUTIVE ORDER 11246)

1. As used in these specifications:

a. "Covered area" means the geographical area described in the solicitation from which this contract resulted;

b. "Director" means Director, Office of Federal Contract Compliance Programs, United States Department of Labor, or any person to whom the Director delegates authority;

c. "Employer identification number" means the Federal Social Security number used on the Employer's Quarterly Federal Tax Return, U.S. Treasury Department Form 941.

d. "Minority" includes:

- i. Black (all persons having origins in any of the Black African racial groups not of Hispanic origin);
- ii. Hispanic (all persons of Mexican, Puerto Rican, Cuban, Central or South American or other Spanish Culture or origin, regardless of race);
- iii. Asian and Pacific Islander (all persons having origins in any of the original peoples of the Far East, Southeast Asia, the Indian Subcontinent, or the Pacific Islands); and
- iv. American Indian or Alaskan Native (all persons having origins in any of the original peoples of North American and maintaining identifiable tribal affiliations through membership and participation or community identification).

2. Whenever the Contractor, or any Subcontractor at any tier, subcontracts a portion of the work involving any construction trade, it shall physically include in each subcontract in excess of \$10,000 the provisions of these specifications and the Notice which contains the applicable goals for minority and female participation and which is set forth in the solicitations from which this contract resulted.

3. If the Contractor is participating (pursuant to 41 CFR 60-4.5) in a Hometown Plan approved by the U.S. Department of Labor in the covered area either individually or through an association, its affirmative action obligations on all work in the Plan area (including goals and timetables) shall be in accordance with that Plan for those trades which have unions participating in the Plan. Contractors must be able to demonstrate their participation in and compliance with the provisions of any such Hometown Plan. Each Contractor or Subcontractor participating in an approved

Plan is individually required to comply with its obligations under the EEO clause, and to make a good faith effort to achieve each goal under the Plan in each trade in which it has employees. The overall good faith performance by other Contractors or Subcontractors toward a goal in an approved Plan does not excuse any covered Contractor's or Subcontractor's failure to take good faith efforts to achieve the Plan goals and timetables.

4. The Contractor shall implement the specific affirmative action standards provided in paragraphs 7a through p of these specifications. The goals set forth in the solicitation from which this contract resulted are expressed as percentages of the total hours of employment and training of minority and female utilization the Contractor should reasonably be able to achieve in each construction trade in which it has employees in the covered area. Covered construction contractors performing construction work in geographical areas where they do not have a Federal or federally assisted construction contract shall apply the minority and female goals established for the geographical area where the work is being performed. Goals are published periodically in the Federal Register in notice form, and such notices may be obtained from any Office of Federal Contract Compliance Programs office or from Federal procurement contracting officers. The Contractor is expected to make substantially uniform progress in meeting its goals in each craft during the period specified.

5. Neither the provisions of any collective bargaining agreement, nor the failure by a union with whom the Contractor has a collective bargaining agreement, to refer either minorities or women shall excuse the Contractor's obligations under these specifications, Executive Order 11246, or the regulations promulgated pursuant thereto.

6. In order for the nonworking training hours of apprentices and trainees to be counted in meeting the goals, such apprentices and trainees must be employed by the Contractor during the training period, and the Contractor must have made a commitment to employ the apprentices and trainees at the completion of their training, subject to the availability of employment opportunities. Trainees must be trained pursuant to training programs approved by the U.S. Department of Labor.

7. The Contractor shall take specific affirmative actions to ensure equal employment opportunity. The evaluation of the Contractor's compliance with these specifications shall be based upon its effort to achieve maximum results from its actions. The

Contractor shall document these efforts fully, and shall implement affirmative action steps at least as extensive as the following:

a. Ensure and maintain a working environment free of harassment, intimidation, and coercion at all sites, and in all facilities at which the Contractor's employees are assigned to work. The Contractor, where possible, will assign two or more women to each construction project. The Contractor shall specifically ensure that all foremen, superintendents, and other on-site supervisory personnel are aware of and carry out the Contractor's obligation to maintain such a working environment, with specific attention to minority or female individuals working at such sites or in such facilities.

b. Establish and maintain a current list of minority and female recruitment sources, provide written notification to minority and female recruitment sources and to community organizations when the Contractor or its unions have employment opportunities available, and maintain a record of the organizations' responses.

c. Maintain a current file of the names, addresses and telephone numbers of each minority and female off-the-street applicant and minority or female referral from a union, a recruitment source or community organization and of what action was taken with respect to each such individual. If such individual was sent to the union hiring hall for referral and was not referred back to the Contractor by the union or, if referred, not employed by the Contractor, this shall be documented in the file with the reason therefor, along with whatever additional actions the Contractor may have taken.

d. Provide immediate written notification to the Director when the union or unions with which the Contractor has a collective bargaining agreement has not referred to the Contractor a minority person or woman sent by the Contractor, or when the Contractor has other information that the union referral process has impeded the Contractor's efforts to meet its obligations.

e. Develop on-the-job training opportunities and/or participate in training programs for the area which expressly include minorities and women, including upgrading programs and apprenticeship and trainee programs relevant to the Contractor's employment needs, especially those programs funded or approved by the Department of Labor. The Contractor shall provide notice of these programs to the sources compiled under 7b above.

f. Disseminate the Contractor's EEO policy by providing notice of the policy to unions and training programs and requesting their cooperation in assisting the Contractor in meeting its EEO obligations; by including it in any policy manual and collective bargaining agreement; by publicizing it in the company newspaper, annual report, etc.; by specific review of the policy with all management personnel and with all minority and female employees before the start of work and then not less often than once every six months; and by posting the company EEO policy on bulletin boards accessible to all employees at each location where construction work is performed.

g. Review the company's EEO policy and affirmative action obligations under these specifications with all employees having any responsibility for hiring, assignment, layoff, termination or other employment decisions including specific review of these items with on-site supervisory personnel such as Superintendents, General Foreman, etc., prior to the initiation of construction work at any job site and then not less often than once every six months. A written record shall be made and maintained identifying the time and place of these meetings, persons attending, subject matter discussed, and disposition of the subject matter.

h. Disseminate the Contractor's EEO policy externally by including it in any advertising in the news media, specifically including minority and female news media, and providing written notification to and discussing the Contractor's EEO policy with other Contractors and Subcontractors with whom the Contractor does or anticipates doing business.

i. Direct its recruitment efforts, both oral and written, to minority, female and community organizations, to schools with minority and female students and to minority and female recruitment and training organizations serving the Contractor's recruitment area and employment needs. Not later than one month prior to the date for the acceptance of applications for apprenticeship or other training by any recruitment source, the Contractor shall send written notification to organizations such as the above describing the openings, screening procedures, and test to be used in the selection process.

j. Encourage present minority and female employees to recruit other minority persons and women and, where reasonable, provide after school, summer and vacation employment to minority and female youth both on the site and in other areas of a Contractor's workforce.

k. Validate all tests and other selection requirements where there is an obligation to do so under 41 CFR Part 60-3.

l. Conduct, at least annually, an inventory and evaluation at least of all minority and female personnel for promotional opportunities and encourage these employees to seek or to prepare for, through appropriate training, etc., such opportunities.

m. Ensure that seniority practices, job classifications, work assignments and other personnel practices, do not have a discriminatory effect by continually monitoring all personnel and employment related activities to ensure that the EEO policy and the Contractor's obligations under these specifications are being carried out.

n. Ensure that all facilities and company activities are non-segregated except that separate or single-user toilet and necessary changing facilities shall be provided to assure privacy between sexes.

o. Document and maintain a record of all solicitations of offers for subcontractors for disadvantaged business

enterprise construction contractors and suppliers, including circulation of solicitations to minority and female contractor associations and other business associations.

p. Conduct a review, at least annually, of all supervisors' adherence to and performance under the Contractor's EEO policies and affirmative action obligations.

8. Contractors are encouraged to participate in voluntary associations which assist in fulfilling one or more of their affirmative action obligations (7a through p). The efforts of a contractor association, joint contractor-union, contractor-community, or other similar group of which the contractor is a member and participant, may be asserted as fulfilling any one or more of its obligations under 7a through p of these Specifications provided that the contractor actively participates in the group, makes every effort to assure that the group has a positive impact on the employment of minorities and women in the industry, ensures that the concrete benefits of the program are reflected in the Contractor's minority and female workforce participation, makes a good faith effort to meet its individual goals and timetables, and can provide access to documentation which demonstrates the effectiveness of actions taken on behalf of the Contractor. The obligation to comply, however, is the Contractor's and failure of such a group to fulfill an obligation shall not be a defense for the Contractor's non-compliance.

9. A single goal for minorities and a separate single goal for women have been established. The Contractor, however, is required to provide equal employment opportunity and to take affirmative action for all minority groups, both male and female, and all women, both minority and non-minority. Consequently, the Contractor may be in violation of the Executive Order if a particular group is employed in a substantially disparate manner (for example, even though the Contractor has achieved its goals for women generally, the Contractor may be in violation of the Executive Order if a specific minority group of women is underutilized).

10. The Contractor shall not use the goals and timetables or affirmative action standards to discriminate against any person because of race, color, religion, sex, national origin, age or disability.

11. The Contractor shall not enter into any Subcontract with any person or firm debarred from Government contracts pursuant to Executive Order 11246.

12. The Contractor shall carry out such sanctions and penalties for violation of these specifications and of the Equal Employment Opportunity Clause, including suspension, termination and cancellation of existing subcontracts as may be imposed or ordered pursuant to Executive Order 11246, as amended, and its implementing regulations, by the Office of Federal Contract Compliance Programs. Any Contractor who fails to carry out such sanctions and penalties shall be in violation of these specifications and Executive Order 11246, as amended.

13. The Contractor, in fulfilling its obligations under these specifications, shall implement specific affirmative action steps, at least as extensive as those standards prescribed in paragraph 7 of

these specifications, so as to achieve maximum results from its efforts to ensure equal employment opportunity. If the Contractor fails to comply with the requirements of the Executive Order, the implementing regulations, or these specifications, the Director shall proceed in accordance with 41CFR60-4.8.

14. The Contractor shall designate a responsible official to monitor all employment related activity to ensure that the company EEO policy is being carried out, to submit reports relating to the provisions hereof as may be required by the Government and to keep records. Records shall at least include for each employee the name, address, telephone numbers, construction trade, union affiliation if any, employee identification number when assigned, social security number, race, sex, status (e.g., mechanic, apprentice, trainee, helper, or laborer), dates of changes in status, hours worked per week in the indicated trade, rate of pay, and locations at which the work was performed. Records shall be maintained in an easily understandable and retrievable form; however, to the degree that existing records satisfy this requirement, contractors shall not be required to maintain separate records.

15. Nothing herein provided shall be construed as a limitation upon the application of other laws which establish different standards of compliance or upon the application of requirements for the hiring of local or other area residents (e.g., those under the Public Works Employment Act of 1977 and the Community Development Block Grant Program).

16. In addition to the reporting requirements set forth elsewhere in this contract, the contractor and the subcontractors holding subcontracts not including material suppliers, of \$10,000 or more, shall submit for every month of July during which work is performed employment data as contained under Form PR-1391 (Appendix C to 23 CFR, Part 230), and in accordance with the instructions included thereon.

7/26/96
Rev. 2/11/98
Rev. 2/20/03
Rev. 7/27/06
Rev. 10/24/06
Rev. 9/16/13
Rev. 8/22/17
Rev. 12/13/23

FHWA-1273 SUPPLEMENTAL SPECIFICATION
POSTERS AND NOTICES REQUIRED FOR FEDERAL-AID PROJECTS

POSTER OR DOCUMENT REQUIRED	REQUIRED BY	WHERE TO OBTAIN
1. Equal Employment Opportunity – Know Your Rights	U.S. Department of Labor (OFCCP)	ARDOT Resident Engineer
2. Company EEO Policy (prepared by the Contractor on the Company's letterhead)	U. S. Department of Labor (OFCCP)	Contractor to Prepare: <ul style="list-style-type: none"> a. EEO policy statement. b. Notice encouraging employees to refer minority and female applicants for employment. c. Notice informing employees of an available training program and the entrance requirements. d. Complaint procedures. e. Notice identifying company EEO officer by name, including address and telephone number where EEO officer can be located. f. Work environment statement. g. Certification of nonsegregated facilities. *h. Notice to unions disseminating EEO commitments and responsibilities and requesting their cooperation.
3. Current Wage Rates (PR-1273 Supplement) or SS Revisions of PR-1273 for Off-System Projects	*Union Contractors Only U. S. Department of Labor	Contained in contract. Extra copies may be obtained from Program Management - ARDOT

7/26/96
Rev. 2/11/98
Rev. 2/20/03
Rev. 7/27/06
Rev. 10/24/06
Rev. 9/16/13
Rev. 8/22/17
Rev. 12/13/23

**FHWA-1273 SUPPLEMENTAL SPECIFICATION
POSTERS AND NOTICES REQUIRED FOR FEDERAL-AID PROJECTS**

POSTER OR DOCUMENT REQUIRED	REQUIRED BY	WHERE TO OBTAIN
4. "Employee Rights Under the Davis-Bacon Act" (WH 1321)	U. S. Department of Labor	ARDOT Resident Engineer
5. "Employee Rights Under the Davis-Bacon Act" (WH 1321 SPA)	U. S. Department of Labor	ARDOT Resident Engineer
6. Minimum Wage Rate (WH 1088)	U. S. Department of Labor	ARDOT Resident Engineer
7. "NOTICE" Federal Aid Projects (PR-1022)	U. S. Department of Transportation (FHWA)	ARDOT Resident Engineer
8. Job Safety and Health Protection OSHA 3165	U. S. Department of Labor (OSHA)	ARDOT Resident Engineer
9. Job Safety and Health Protection OSHA 3167 SPA	U. S. Department of Labor (OSHA)	ARDOT Resident Engineer
10. Emergency Phone Numbers of Doctors, Hospital and Ambulance near Job Site for referring injured employees.	U. S. Department of Labor (OSHA)	ARDOT Resident Engineer
11. WCC Form AR-P Workers Compensation Notice and Instructions to Employers and Employees	State of Arkansas	Insurance Carrier
Self-Insurer	State of Arkansas	Administrator - Self-Insured Group

7/26/96
Rev. 2/11/98
Rev. 2/20/03
Rev. 7/27/06
Rev. 10/24/06
Rev. 9/16/13
Rev. 8/22/17
Rev. 12/13/23

**FHWA-1273 SUPPLEMENTAL SPECIFICATION
POSTERS AND NOTICES REQUIRED FOR FEDERAL-AID PROJECTS**

POSTER OR DOCUMENT REQUIRED	REQUIRED BY	WHERE TO OBTAIN
12. Log and Summary of Occupational Injuries and Illnesses (OSHA Form 300) The Summary portion must be posted from February 1 to April 30, of the year following the year covered by the form.	U. S. Department of Labor (OSHA) Public Law 91-596	ARDOT Resident Engineer
13. Family and Medical Leave Act of 1993 (WH-1420) Employers who employ 50 or more employees for at least 20 workweeks in the current or preceding calendar year.	U. S. Department of Labor	ARDOT Resident Engineer
14. Employee Polygraph Protection Act (WH-1462)	U. S. Department of Labor	ARDOT Resident Engineer
15. Your Rights Under USERRA (The Uniformed Services Employment and Reemployment Rights Act)	U. S. Department of Labor	ARDOT Resident Engineer
16. Arkansas Department of Labor Notice to Employer & Employee	Arkansas Department of Labor	ARDOT Resident Engineer
17. Pay Transparency Nondiscrimination Provision	U. S. Department of Labor (OFCCP)	ARDOT Resident Engineer

ARKANSAS DEPARTMENT OF TRANSPORTATION
SUPPLEMENTAL SPECIFICATION
WAGE RATE DETERMINATION

"General Decision Number: AR20240175 01/05/2024

Superseded General Decision Number: AR20230175

State: Arkansas

Construction Type: Highway

Counties: Perry and Saline Counties in Arkansas.

HIGHWAY CONSTRUCTION PROJECTS

Note: Contracts subject to the Davis-Bacon Act are generally required to pay at least the applicable minimum wage rate required under Executive Order 14026 or Executive Order 13658. Please note that these Executive Orders apply to covered contracts entered into by the federal government that are subject to the Davis-Bacon Act itself, but do not apply to contracts subject only to the Davis-Bacon Related Acts, including those set forth at 29 CFR 5.1(a)(1).

If the contract is entered into on or after January 30, 2022, or the contract is renewed or extended (e.g., an option is exercised) on or after January 30, 2022:	. Executive Order 14026 generally applies to the contract. . The contractor must pay all covered workers at least \$17.20 per hour (or the applicable wage rate listed on this wage determination, if it is higher) for all hours spent performing on the contract in 2024.
If the contract was awarded on or between January 1, 2015 and January 29, 2022, and the contract is not renewed or extended on or after January 30, 2022:	. Executive Order 13658 generally applies to the contract. . The contractor must pay all covered workers at least \$12.90 per hour (or the applicable wage rate listed on this wage determination, if it is higher) for all hours spent performing on that contract in 2024.

The applicable Executive Order minimum wage rate will be adjusted annually. If this contract is covered by one of the Executive Orders and a classification considered necessary for performance of work on the contract does not appear on this wage determination, the contractor must still submit a conformance request.

Additional information on contractor requirements and worker protections under the Executive Orders is available at <http://www.dol.gov/whd/govcontracts>.

ARKANSAS DEPARTMENT OF TRANSPORTATION
 SUPPLEMENTAL SPECIFICATION
 WAGE RATE DETERMINATION

Modification Number Publication Date
 0 01/05/2024

SUAR2014-047 07/21/2014

	Rates	Fringes
CARPENTER, Includes Form Work....	\$ 14.09 **	0.00
CEMENT MASON/CONCRETE FINISHER...	\$ 15.11 **	0.00
FENCE ERECTOR.....	\$ 12.69 **	0.00
HIGHWAY/PARKING LOT STRIPING: Operator (Striping Machine)....	\$ 13.25 **	0.00
HIGHWAY/PARKING LOT STRIPING: Painter.....	\$ 21.75	0.00
IRONWORKER, REINFORCING.....	\$ 14.22 **	0.00
IRONWORKER, STRUCTURAL.....	\$ 15.36 **	0.00
LABORER: Asphalt, Includes Raker, Shoveler, Spreader and Distributor.....	\$ 14.45 **	0.00
LABORER: Common or General.....	\$ 11.94 **	0.00
LABORER: Mason Tender - Cement/Concrete.....	\$ 15.23 **	0.00
LABORER: Pipelayer.....	\$ 14.33 **	0.00
OPERATOR: Asphalt Spreader.....	\$ 15.80 **	0.00
OPERATOR: Backhoe/Excavator/Trackhoe.....	\$ 17.24	0.00
OPERATOR: Bobcat/Skid Steer/Skid Loader.....	\$ 16.06 **	0.00
OPERATOR: Broom/Sweeper.....	\$ 12.00 **	0.00
OPERATOR: Bulldozer.....	\$ 16.74 **	0.00
OPERATOR: Crane.....	\$ 20.63	0.00
OPERATOR: Distributor.....	\$ 14.52 **	0.00
OPERATOR: Drill.....	\$ 14.85 **	0.00
OPERATOR: Grade Checker.....	\$ 16.24 **	0.00
OPERATOR: Grader/Blade.....	\$ 20.04	0.00
OPERATOR: Hydroseeder.....	\$ 10.79 **	0.00
OPERATOR: Loader.....	\$ 17.05 **	0.00

ARKANSAS DEPARTMENT OF TRANSPORTATION
 SUPPLEMENTAL SPECIFICATION
 WAGE RATE DETERMINATION

OPERATOR: Mechanic.....	\$ 22.19	0.00
OPERATOR: Milling Machine.....	\$ 17.52	0.00
OPERATOR: Oiler.....	\$ 18.46	0.00
OPERATOR: Paver (Asphalt, Aggregate, and Concrete).....	\$ 17.89	0.00
OPERATOR: Post Driver (Guardrail/Fences).....	\$ 16.97 **	0.00
OPERATOR: Roller.....	\$ 15.69 **	0.00
OPERATOR: Scraper.....	\$ 19.31	0.00
OPERATOR: Screed.....	\$ 15.01 **	0.00
TRAFFIC CONTROL: Flagger.....	\$ 12.67 **	0.00
TRAFFIC CONTROL: Laborer-Cones/ Barricades/Barrels - Setter/Mover/Sweeper.....	\$ 12.95 **	0.00
TRUCK DRIVER: Dump Truck.....	\$ 14.81 **	0.00
TRUCK DRIVER: Flatbed Truck.....	\$ 21.03	0.00
TRUCK DRIVER: Lowboy Truck.....	\$ 17.49	0.00
TRUCK DRIVER: Servicer.....	\$ 15.90 **	0.00
TRUCK DRIVER: Water Truck.....	\$ 14.73 **	0.00
TRUCK DRIVER: Semi/Trailer Truck.....	\$ 12.50 **	0.00

WELDERS - Receive rate prescribed for craft performing operation to which welding is incidental.

=====

** Workers in this classification may be entitled to a higher minimum wage under Executive Order 14026 (\$17.20) or 13658 (\$12.90). Please see the Note at the top of the wage determination for more information. Please also note that the minimum wage requirements of Executive Order 14026 are not currently being enforced as to any contract or subcontract to which the states of Texas, Louisiana, or Mississippi, including their agencies, are a party.

Note: Executive Order (EO) 13706, Establishing Paid Sick Leave for Federal Contractors applies to all contracts subject to the Davis-Bacon Act for which the contract is awarded (and any solicitation was issued) on or after January 1, 2017. If this contract is covered by the EO, the contractor must provide employees with 1 hour of paid sick leave for every 30 hours they work, up to 56 hours of paid sick leave each year.

Employees must be permitted to use paid sick leave for their own illness, injury or other health-related needs, including preventive care; to assist a family member (or person who is like family to the employee) who is ill, injured, or has other health-related needs, including preventive care; or for reasons resulting from, or to assist a family member (or person who is like family to the employee) who is a victim of, domestic violence, sexual assault, or stalking. Additional information on contractor requirements and worker protections under the EO is available at <https://www.dol.gov/agencies/whd/government-contracts>.

Unlisted classifications needed for work not included within the scope of the classifications listed may be added after award only as provided in the labor standards contract clauses (29CFR 5.5 (a) (1) (iii)).

The body of each wage determination lists the classification and wage rates that have been found to be prevailing for the cited type(s) of construction in the area covered by the wage determination. The classifications are listed in alphabetical order of ""identifiers"" that indicate whether the particular rate is a union rate (current union negotiated rate for local), a survey rate (weighted average rate) or a union average rate (weighted union average rate).

Union Rate Identifiers

A four letter classification abbreviation identifier enclosed in dotted lines beginning with characters other than ""SU"" or ""UAVG"" denotes that the union classification and rate were prevailing for that classification in the survey. Example: PLUM0198-005 07/01/2014. PLUM is an abbreviation identifier of the union which prevailed in the survey for this classification, which in this example would be Plumbers. 0198 indicates the local union number or district council number where applicable, i.e., Plumbers Local 0198. The next number, 005 in the example, is an internal number used in processing the wage determination. 07/01/2014 is the effective date of the most current negotiated rate, which in this example is July 1, 2014.

Union prevailing wage rates are updated to reflect all rate changes in the collective bargaining agreement (CBA) governing this classification and rate.

Survey Rate Identifiers

Classifications listed under the ""SU"" identifier indicate that no one rate prevailed for this classification in the survey and the published rate is derived by computing a weighted average rate based on all the rates reported in the survey for that classification. As this weighted average rate includes all rates reported in the survey, it may include both union and non-union rates. Example: SULA2012-007 5/13/2014. SU indicates the rates are survey rates based on a weighted average

calculation of rates and are not majority rates. LA indicates the State of Louisiana. 2012 is the year of survey on which these classifications and rates are based. The next number, 007 in the example, is an internal number used in producing the wage determination. 5/13/2014 indicates the survey completion date for the classifications and rates under that identifier.

Survey wage rates are not updated and remain in effect until a new survey is conducted.

Union Average Rate Identifiers

Classification(s) listed under the UAVG identifier indicate that no single majority rate prevailed for those classifications; however, 100% of the data reported for the classifications was union data. EXAMPLE: UAVG-OH-0010 08/29/2014. UAVG indicates that the rate is a weighted union average rate. OH indicates the state. The next number, 0010 in the example, is an internal number used in producing the wage determination. 08/29/2014 indicates the survey completion date for the classifications and rates under that identifier.

A UAVG rate will be updated once a year, usually in January of each year, to reflect a weighted average of the current negotiated/CBA rate of the union locals from which the rate is based.

WAGE DETERMINATION APPEALS PROCESS

1.) Has there been an initial decision in the matter? This can be:

- * an existing published wage determination
- * a survey underlying a wage determination
- * a Wage and Hour Division letter setting forth a position on a wage determination matter
- * a conformance (additional classification and rate) ruling

On survey related matters, initial contact, including requests for summaries of surveys, should be with the Wage and Hour National Office because National Office has responsibility for the Davis-Bacon survey program. If the response from this initial contact is not satisfactory, then the process described in 2.) and 3.) should be followed.

With regard to any other matter not yet ripe for the formal process described here, initial contact should be with the Branch of Construction Wage Determinations. Write to:

Branch of Construction Wage Determinations
Wage and Hour Division
U.S. Department of Labor
200 Constitution Avenue, N.W.
Washington, DC 20210

2.) If the answer to the question in 1.) is yes, then an

ARKANSAS DEPARTMENT OF TRANSPORTATION
SUPPLEMENTAL SPECIFICATION
WAGE RATE DETERMINATION

interested party (those affected by the action) can request review and reconsideration from the Wage and Hour Administrator (See 29 CFR Part 1.8 and 29 CFR Part 7). Write to:

Wage and Hour Administrator
U.S. Department of Labor
200 Constitution Avenue, N.W.
Washington, DC 20210

The request should be accompanied by a full statement of the interested party's position and by any information (wage payment data, project description, area practice material, etc.) that the requestor considers relevant to the issue.

3.) If the decision of the Administrator is not favorable, an interested party may appeal directly to the Administrative Review Board (formerly the Wage Appeals Board). Write to:

Administrative Review Board
U.S. Department of Labor
200 Constitution Avenue, N.W.
Washington, DC 20210

4.) All decisions by the Administrative Review Board are final.

=====
END OF GENERAL DECISION"

ARKANSAS DEPARTMENT OF TRANSPORTATION

SPECIAL PROVISION

JOB NO. A80035

CARGO PREFERENCE ACT REQUIREMENTS

The requirements of the Cargo Preference Act (CPA) and implementing regulations (46 CFR 381.7(a)-(b)) are applicable to this contract. For additional information, see the FHWA's web page:

<https://www.fhwa.dot.gov/construction/cqit/cargo.cfm>

ARKANSAS DEPARTMENT OF TRANSPORTATION
SPECIAL PROVISION
JOB A80035

GOALS FOR DISADVANTAGED BUSINESS ENTERPRISE PARTICIPATION

A Disadvantaged Business Enterprise (DBE) goal of 5.0% has been established for this contract. Therefore, the provisions of subsection 103.08 of the Standard Specifications for Highway Construction, Edition of 2014, as revised, apply.

Requirements of Subsection 103.08 apply to successful bidders that are certified by the Department as a DBE. The Prime Contractor must meet the DBE goal. If the Prime Contractor is a Department certified DBE, then the work the Prime Contractor performs with its own forces, as well as work committed to be performed by DBE subcontractors and suppliers will count toward the goal. Therefore, DBE bidders should list work to be performed with its own forces on the DBE Participation form, along with DBE subcontractors to be utilized in achieving the goal.

All payments made to DBE Contractors, suppliers, manufacturers, and/or non-construction service firms must be reported by the Prime Contractor. This includes all payments made to DBE firms utilized in achieving the project goal and DBE firms that perform work that is not listed in the Disadvantaged Business Enterprise Participation form submitted with the executed Contract.

As required by Subsection 103.08(h), the Prime Contractor must use the appropriate DBE Payment Log form included in this Special Provision during the progress of the Contract. Listed below are the instructions on when each form is required to be submitted.

- The Prime DBE Payment Log (page 4) must be submitted by the Prime Contractor when he/she is a certified DBE Contractor and work was performed by their own forces or money was earned by the DBE Prime Contractor for work performed by a Subcontractor during the estimate period.
- The DBE Subcontractor Payment Log (page 3) must be submitted by the Prime Contractor when a Subcontractor is a certified DBE Contractor and work was performed by a Subcontractor or money was earned by a Subcontractor for work performed by a Second-tier Subcontractor during the estimate period.
- The 2nd Tier DBE Payment Log (page 5) must be submitted by the Prime Contractor when a 2nd Tier Subcontractor is a certified DBE Contractor and work was performed by a 2nd Tier Subcontractor during the estimate period.
- The 2nd Tier DBE Payment Log (page 5) must be submitted by the Prime Contractor when payments are made to a Department Certified DBE supplier, manufacturer, and/or non-construction service firm by the Prime Contractor or any Subcontractor or 2nd Tier Subcontractor during the estimate period.

ARKANSAS DEPARTMENT OF TRANSPORTATION
SPECIAL PROVISION
JOB A80035

GOALS FOR DISADVANTAGED BUSINESS ENTERPRISE PARTICIPATION

A separate DBE Payment Log form is required for each DBE firm receiving payments for work completed or services provided during each estimate period. The DBE Payment Log forms, along with instructions for their use, are available on the Department's website at:

https://www.ardot.gov/wp-content/uploads/2021/01/DBE_Log.xlsx

All certifications of payments must be received by the Resident Engineer within thirty-five (35) calendar days following the end of each estimate period. Facsimile or scanned copies of the completed original payment log forms are acceptable to fulfill this requirement.

Upon completion of the contract, a final certificate of payments to all DBE firms -- page 6 of this Special Provision -- is required by Subsection 103.08 (h). The final amount paid to each DBE firm shall match the total to date reported on the last DBE payment log submitted for each firm. If necessary, an additional DBE payment log shall be submitted with the certificate of payment itemizing all payments made to DBE firms since the last estimate period. A signed, original of the Final Certificate of Payment must be furnished to the Resident Engineer.

**Arkansas Department of Transportation
DBE Subcontractor Payment Log**

Job Number _____ Prime Contractor _____

Estimate No. _____ DBE Subcontractor _____

Estimate Ending Date _____ Date Payment Made to DBE _____

Item Code*	Item Description	Subcontract Unit Price	2 nd Tier Unit Price	Quantity	Value Earned By Subcontractor

* Item Codes for pay items are shown on the estimate voucher

Total This Estimate

Retainage Withheld This Estimate

Net Total This Estimate

____% Retainage

Previous Total

Total To Date

DBE Payment Log must be received
within 35 calendar days of the ending
date of the estimate.

The Prime Contractor certifies that the payment listed has been made to the DBE Subcontractor and that the documentation of this payment is available for inspection upon request.

Authorized Signature _____ Title _____

Typed or Printed Name _____ Date _____

Department
Use Only

Received

Verified

By _____

By _____

Date _____

Date _____ RE Initials

**Arkansas Department of Transportation
DBE Prime Contractor Payment Log**

Job Number _____ DBE Prime Contractor _____

Estimate No. _____

Estimate Ending Date _____

Item Code*	Item Description	Contract Unit Price	Sub Unit Price	Quantity	Value Earned By DBE Prime

* Item Codes for pay items are shown on the estimate voucher

Total This Estimate

Previous Total

Total To Date

DBE Payment Log must be received within 35 calendar days of the ending date of the estimate.

The Prime Contractor certifies that the information shown above is correct and represents the value earned by the DBE Prime Contractor during the above estimate period.

Authorized Signature _____ Title _____

Typed or Printed Name _____ Date _____

Department Use Only

Received	Verified
By _____	By _____
Date _____	Date _____
	RE Initials _____

**Arkansas Department of Transportation
DBE 2nd Tier Payment Log**

Job Number _____ Prime Contractor _____
 Estimate No. _____ Subcontractor _____
 Estimate Ending Date _____ DBE 2nd Tier Subcontractor _____
 Date Payment Made to DBE _____

Item Code*	Item Description	2nd Tier Unit Price	Quantity	Value Earned by 2nd Tier

* Item Codes for pay items are shown on the estimate voucher

Total This Estimate

Retainage Withheld This Estimate

Net Total This Estimate

DBE Payment Log must be received within 35 calendar days of the ending date of the estimate.

____% Retainage

Previous Total

Total To Date

The Prime Contractor certifies that the payment listed has been made to the DBE 2nd Tier Subcontractor and that the documentation of this payment is available for inspection upon request.

Authorized Signature _____ Title _____
 Typed or Printed Name _____ Date _____

Department Use Only

Received	Verified
By _____	By _____
Date _____	Date _____

RE Initials _____

ARKANSAS DEPARTMENT OF TRANSPORTATION CERTIFICATE OF PAYMENT

JOB _____ F.A.P. _____

JOB NAME _____

ORIGINAL CONTRACT AMOUNT \$ _____ DBE GOAL \$ _____*

(Contract Commitment)

DBE CONTRACT GOAL ___%

FINAL PAYMENT TO DBEs

The undersigned Contractor on the above mentioned project hereby certifies that the following amount(s) were paid to:

<u>DBE Subcontractor(s)</u>	<u>Amount Paid</u>
	\$
	\$
	\$
	\$
	\$
	\$
	\$
	\$
	\$
	\$
	\$
	\$
	\$
Total Paid to DBEs	\$

Only payments related to work, services, or material actually provided by DBE firms should be shown. Payments under second tier subcontracts from DBE firms to non-DBE firms should not be included. **DBE prime Contractors should include the value of work performed by its own forces.**

Contractor:			
Signature:			
Typed or Printed Name:			
Title:		Date:	

THIS "CERTIFICATE OF PAYMENT" IS TO BE SUBMITTED TO THE RESIDENT ENGINEER PRIOR TO PROJECT ACCEPTANCE.

* If goal not met, brief explanation: _____

Rev. 12-13-16
Rev. 11-07-19
Rev. 3-8-24

ARKANSAS DEPARTMENT OF TRANSPORTATION

CERTIFICATION TO SUBMIT DBE PARTICIPATION

JOB A80035

By submitting an internet proposal, the bidder irrevocably certifies that an amount equal to or greater than the Disadvantaged Business Enterprise (DBE) Goal established for this project will be performed by certified Disadvantaged Business Enterprise firms and the required DBE participation information will be submitted within 5 calendar days of the date of the bid opening.

Within five (5) calendar days of the date of the bid letting, all bidders shall furnish the required DBE Participation information to the Department on the forms provided to be considered a responsive bid. If a conditional award has been made and the successful bidder has not furnished the required information, the proposal will be rejected and their proposal guaranty forfeited. The proposal guaranty shall become property of the Commission, not as a penalty, but in liquidation of damages, sustained to the DBE Program. Award may then be made to the next lowest, responsive bidder or the work may be re-advertised as the Commission may decide.

Only work, materials, or services that will actually be provided by DBE firms will be credited toward the goal. The DBE firm's certification must be fully in effect at the letting date.

As an alternative, documentation of Good Faith Efforts to meet the DBE goal may be submitted to the Program Management Division prior to the deadline for proposals to be received.

ARKANSAS DEPARTMENT OF TRANSPORTATION

SPECIAL PROVISION

JOB NO. A80035

**DISADVANTAGED BUSINESS ENTERPRISE
BIDDER'S RESPONSIBILITIES**

Section 103 of the Standard Specifications for Highway Construction, Edition of 2014, is hereby amended as follows:

Subsection 103.08(d)(2) is hereby deleted and the following substituted therefore:

(2) Within five (5) calendar days of the date of the bid letting, all bidders shall furnish the required DBE Participation information to the Department on the forms provided to be considered a responsive bid. If a conditional award has been made and the successful bidder has not furnished the required information, the proposal will be rejected and their proposal guaranty forfeited. The proposal guaranty shall become property of the Commission, not as a penalty, but in liquidation of damages, sustained to the DBE Program. Award may then be made to the next lowest, responsive bidder or the work may be re-advertised as the Commission may decide. Furthermore, any subsequent bidder's proposal will be considered non-responsive if their required DBE participation information was not submitted within the required five day period.

ARKANSAS DEPARTMENT OF TRANSPORTATION

SPECIAL PROVISION

JOB NO. A80035

**PROHIBITION OF CERTAIN TELECOMMUNICATIONS AND
VIDEO SURVEILLANCE SERVICES OR EQUIPMENT**

In accordance with the requirements of 2 CFR 200.216, equipment utilized on this project for telecommunications and video surveillance services or equipment shall not be produced by:

- 1) Huawei Technologies Company or ZTE Corporation (or any subsidiary or affiliate of such entities).
- 2) Hytera Communications Corporation, Hangzhou Hikvision Digital Technology Company, or Dahua Technology Company (or any subsidiary or affiliate of such entities).

ARKANSAS DEPARTMENT OF TRANSPORTATION**SPECIAL PROVISION****JOB NO. A80035****BUY AMERICA - CONSTRUCTION MATERIALS**

Description: Section 106, Control of Material, of the Standard Specifications for Highway Construction, Edition of 2014, is hereby amended as follows:

The following is added as **Subsection 106.01(c) Construction Materials**

Buy America – Construction Materials. (1) General. The Bipartisan Infrastructure Law (BIL) was enacted on November 15, 2021 (BIL Build America, Buy America Act Publication L. No. 117-58). This provision expands the Buy America requirements beyond what was only required for steel and iron products. The steel and iron provisions have not changed with the new law. Buy America requirements are in effect only on Federal-Aid contracts and all construction materials shall be produced/manufactured in the United States. Items specifically excluded from this requirement are cement and cementitious materials; aggregates such as stone, sand, or gravel; aggregate binding agents or additives (including asphalt binders). All other materials permanently incorporated into the project will be subject to Buy America requirements.

(2) Definitions. A construction material includes an article, material, or supply that is or consists primarily of:

- non-ferrous metals;
- plastic and polymer-based products (including polyvinylchloride, composite building materials, and polymers used in fiber optic cable);
- glass (including optic glass);
- lumber; or
- drywall.

Items manufactured through a combination of either two or more materials listed above, or at least one of the materials listed above and a material not listed shall be considered as a manufactured product, rather than as a construction material.

Build America, Buy America provisions specified for manufactured products in Section 70912(6)(B) of the Infrastructure Investment and Job Act (IIJA) do not apply to federal-aid construction projects per FHWA's existing statutory requirement applicable to manufactured products. A "manufactured product" is considered to be an item that undergoes one or more manufacturing processes before the item can be used on a construction project.

All construction materials shall be produced in the United States. This means all manufacturing processes to produce the construction materials shall occur in the United States. All manufacturing processes for construction materials shall mean the final manufacturing process and the immediately preceding manufacturing stage for the construction material.

(3) Compliance. The Contractor shall ensure that all manufacturing processes for each covered product comply with this Buy America Provision. Non-conforming products shall be replaced at no expense to the Department. It is the contractor's responsibility to assure all submittals required for Buy America are submitted to the Engineer prior to the products and or materials being incorporated into the project.

Buy America requirements do not apply to temporary elements not permanently incorporated into a project. This includes falsework, temporary sheet piling, detour bridges, temporary elements left in place at the contractor's convenience, unless the contract plans and specifications require steel or iron components or imply that the item be left in place, or items that are simply moved from one place to another within the same project. Buy America only applies to construction

ARKANSAS DEPARTMENT OF TRANSPORTATION

SPECIAL PROVISION

JOB NO. A80035

BUY AMERICA - CONSTRUCTION MATERIALS

materials that are consumed in, incorporated into, or affixed to an infrastructure project. As such, it does not apply to tools, equipment, and supplies, such as temporary scaffolding, removed at or before completion of the project.

(4). Certification. The contractor shall provide a certification from the supplier for each construction material, stating that it meets the provisions of this specification or the Build America/Buy America act, prior to incorporating any construction material into the project. The supplier certifying may be the original manufacturer, fabricator, or vendor provided the supplier has sufficient control and knowledge of the manufacturing process to accept responsibility and certify full and complete conformance with the certification.

(5). Examples of Pay Items Affected. The following are items from the Standard Specifications that must meet the requirements of this specification. This list is provided for bidders' information and is not to be considered as all-inclusive as other items covered by the standard specifications, supplemental specifications, and special provisions may also fall under these requirements:

Non-Ferrous Metals	
Item	Specification Section
Aluminum Pipe Culverts	606
Aluminum Chain Link Fence	619
Aluminum Gates	619
Mailboxes	637
Electrical Conductors	700, 708
Ground Rods	701, 712, 714, 715
Loop Wiring	704
Feeder Wire	704
Traffic Signal Cable	708
Sign Supports	724, 730
Sign Panels	723, 725, 726, 727, 728
Video Cable	733
Metal Bridge Railing	806
Bridge Name Plates	812

Plastic/Polymer Based Products	
Item	Specification Section
Polyethylene Pipe Culverts	606
PVC Pipe Culverts	606
RC Pipe Culvert Gaskets	606
Drop Inlet Steps	609, 610, 640
ABS or Polyethylene Pipe for Underdrains	611
PVC Pipe for Underdrain Laterals	611
Filter Fabrics	611, 625, 629, 816
Geotextile Fabrics	625
Tactile Panels for Wheelchair Ramps	641
Non-Metallic Conduit (PE & PVC)	710
Sand Barrels/Lids for Impact Attenuation Barriers	731

ARKANSAS DEPARTMENT OF TRANSPORTATION

SPECIAL PROVISION

JOB NO. A80035

BUY AMERICA - CONSTRUCTION MATERIALS

Glass	
Item	Specification Section
Glass Beads (drop on application)	718, 719
Fiber Optic Cable	Job SP
Windows in Building Construction	Job SP

Lumber	
Item	Specification Section
Wood Guard Rail Posts	617, 639
Wood Block Outs for Guardrail	617,639
Wood Posts for Guard Cable	618
Fence Posts and Braces (Type A, B, C and D)	619
Mailbox Supports	637
Treated Wood Poles	716
Treated Lumber	817
Treated Bridge Timbers	817
Timber Piling	818
Framing Lumber, Plywood, Trim Lumber in Building Construction	Job SP

Drywall	
Item	Specification Section
Drywall in Building Construction	Job SP

ARKANSAS DEPARTMENT OF TRANSPORTATION

SPECIAL PROVISION

JOB NO. A80035

BIDDING REQUIREMENTS AND CONDITIONS

Section 102 of the Standard Specifications for Highway Construction, Edition of 2014, is hereby amended as follows:

The fourth sentence of the second paragraph of **Subsection 102.01** is hereby deleted, and the following substituted therefore:

Prospective bidders may file a questionnaire at any time; however, prospective bidders will not be given authorization to submit a proposal unless a rating has been extended based on an acceptable questionnaire.

The last paragraph of **Subsection 102.01** is hereby deleted.

The second sentence of **Subsection 102.02** is hereby deleted, and the following substituted therefore:

The Notice to Contractors will contain a description of the proposed work, and information regarding access to proposal documents, plans, specifications, and the amount and nature of the proposal guaranty.

Subsection 102.03 is hereby deleted, renamed **Contents of Proposal Documents**, and the following substituted therefore:

The proposal documents will state the location and description of the contemplated construction and will show the estimate of the various quantities and kinds of work to be performed or materials to be furnished, and will have a schedule of items. The proposal documents will state the time in which the work must be completed, the amount of the proposal guaranty, and the date and time of the letting of work. The documents will also include any special provisions or requirements that vary from or are not contained in the standard specifications.

All forms included in the proposal documents are considered a part thereof. The plans, specifications, and other documents designated in the proposal documents will be considered a part of the proposal whether included or not.

The first through fourth paragraphs of **Subsection 102.04** are hereby deleted, and the following substituted therefore:

To become an eligible bidder, prospective bidders must be registered to bid in Arkansas with Bid Express. Prospective bidders must also contact the Program Management Division at (501) 569-2261 during regular business hours between the date the project is advertised and 4:30 p.m. on the day prior to the scheduled bid opening to request to become eligible to bid specific projects. Only prequalified contractors or their authorized representative may request to become an eligible bidder.

ARKANSAS DEPARTMENT OF TRANSPORTATION

SPECIAL PROVISION

JOB NO. A80035

BIDDING REQUIREMENTS AND CONDITIONS

If the prospective bidder's prequalification rating is not "unlimited", the bidder shall file a certification with the Department citing all contracts in force and the unfinished value of such work. A prospective bidder will not be allowed to submit a proposal until a certification for the current bidding period is on file and the amount of work the contractor may be allowed to undertake is determined. The contractor's prequalification rating, less the unfinished value of all contracts in force, will determine the amount of additional work that the contractor may be allowed to undertake. A contractor will not be allowed to submit a proposal on an individual project for which the estimated cost is more than the amount that the contractor may be allowed to undertake, but the contractor will be allowed to submit a proposal on more than one project, providing that the estimated cost of each project is not more than the amount that the contractor may be allowed to undertake. In the event a contractor submits a low bid on more than one project and the aggregate amount is greater than the amount the contractor may be allowed to undertake, the Commission will exercise its discretion in the award of a particular project or projects.

A charge will be assessed for authorization to submit a proposal, paper copies of the proposal documents, and plans issued. These services are provided during regular business hours until 4:30 p.m. on the day prior to the scheduled bid opening at the Arkansas Department of Transportation, 10324 Interstate 30, Little Rock, Arkansas 72209, (501) 569-2261. Payment shall be made at the time services are provided or upon receipt of statement therefore. No refund will be allowed for bids not submitted or for plans or proposal documents returned.

The second sentence of the first paragraph of **Subsection 102.06** is hereby deleted, and the following substituted therefore:

The bidder is expected to examine carefully the site of the proposed work, the proposal documents, plans, specifications, supplemental specifications, and special provisions before submitting a proposal.

The first paragraph of **Subsection 102.07** is hereby deleted, and the following substituted therefore:

The proposal shall only be submitted through the internet bidding service, Bid Express. The bidder shall specify a unit price in figures for each pay item for which a quantity is given. A unit price of "zero" (\$0.00) is a valid price and will be considered. A blank unit price is not considered valid. The unit bid price should not be carried beyond 1 cent (\$0.01). Any figures on the unit bid price beyond 1 cent will be dropped.

The second and third paragraphs of **Subsection 102.07** are hereby deleted.

ARKANSAS DEPARTMENT OF TRANSPORTATION

SPECIAL PROVISION

JOB NO. A80035

BIDDING REQUIREMENTS AND CONDITIONS

The fifth paragraph of **Subsection 102.07** is hereby deleted, and the following substituted therefore:

The bidder's proposal must be submitted with a digital signature containing the name of the individual, one or more members of the partnership, one or more members or officers of each firm representing a joint venture, or one or more officers of a corporation, or by an agent of the Contractor legally qualified and acceptable to the Department.

The sixth paragraph of **Subsection 102.07** is hereby deleted, and the following substituted therefore:

If the proposal is submitted with a digital signature of any person who is not listed in the bidder's Prequalification Questionnaire (Questionnaire Form) as the individual, as a partner of a partnership, or as an officer of a corporation, authorization for such submittal should be on file with the Department prior to the download of bids. This authorization shall be made before the downloading of bids and be in the form of a Power of Attorney duly executed and signed by an official with power to constitute such authority.

The last sentence of the seventh paragraph of **Subsection 102.07** is hereby deleted, and the following substituted therefore:

Those items of Asphalt Binder that are subject to a minimum bid price will bear the note "(Minimum bid price is \$120.00 per ton)" within the Schedule of Items of the proposal documents.

The first sentence of the ninth paragraph of **Subsection 102.07** is hereby deleted, and the following substituted therefore:

The proposal documents for all federal aid projects will contain a bidders list.

The last sentence of the ninth paragraph of **Subsection 102.07** is hereby deleted, and the following substituted therefore:

The information provided will not be used for contract awarding purposes but must be provided before the Contractor will be given authorization to submit proposals for future lettings.

Subsection 102.08 Irregular Proposals is hereby deleted, and the following substituted therefore:

- (a) Proposals will be considered irregular and will be rejected for the following reasons:
- (1) If the proposal does not contain a unit price for each pay item listed except in the case of authorized alternate pay items.
 - (2) If the proposal is not digitally signed by an authorized representative of the firm.

ARKANSAS DEPARTMENT OF TRANSPORTATION

SPECIAL PROVISION

JOB NO. A80035

BIDDING REQUIREMENTS AND CONDITIONS

- (3) If the proposal is not accompanied by the proper proposal guaranty.
- (4) If a proposal is received from an individual, firm, partnership, or corporation with an interest, as principal, in another proposal for the same project.
- (5) If the proposal is not accompanied by the Certification to Submit DBE Participation.
- (b) Proposals will be considered irregular and may be rejected for the following reasons:
 - (1) If the proposal is not accompanied by a bid schedule and bid schedule narrative as required in the proposal documents.
 - (2) Unbalanced proposals in which the prices for some items are out of proportion to the reasonable costs representative of those items.
 - (3) If there are irregularities of any kind that may tend to make the proposal incomplete, indefinite, or ambiguous as to its meaning.

The first sentence of **Subsection 102.09** is hereby deleted and the following substituted therefore:

No proposal will be considered by the Commission unless a guaranty in the form of a bank draft, certified check, or cashier's check drawn on a solvent bank or trust company, or a bidder's paper bond executed by an approved surety company has been received by the Program Management Division prior to the download of bids.

The following paragraph is hereby added after the first paragraph of **Subsection 102.09**:

Electronic bid bonds are allowed. The prospective bidder should verify their bid bond in their proposal prior to submission.

Subsection 102.10 is hereby deleted and the following substituted therefore:

The proposal shall only be submitted through the internet bidding service, Bid Express.

Subsection 102.11 is hereby deleted, and the following substituted therefore:

A bidder may withdraw or modify a proposal after it has been submitted to Bid Express, up to the time set for the deadline for proposals to be received. A proposal may also be withdrawn if the Commission fails to make an award within 40 calendar days after the date of downloading.

ARKANSAS DEPARTMENT OF TRANSPORTATION

SPECIAL PROVISION

JOB NO. A80035

BIDDING REQUIREMENTS AND CONDITIONS

Subsection 102.12 is hereby deleted, renamed **Downloading of Proposals**, and the following substituted therefore:

Proposals will be downloaded and then posted on the Department's website at the time and place indicated in the Notice to Contractors.

The last sentence of **Subsection 102.15** is hereby deleted, and the following substituted therefore:

In any case, the prospective bidders will be contacted prior to the download of bids.

ARKANSAS DEPARTMENT OF TRANSPORTATION

SPECIAL PROVISION

JOB NO. A80035

MANDATORY ELECTRONIC CONTRACT

Paper Contract Documents and Forms will not be accepted.

The Department will only accept and execute an electronic contract for this project through Doc Express, a paperless contracting system. Prospective bidders will need to contact Doc Express to set up an account prior to the bid opening date. The toll-free phone number for Doc Express is 1-888-352-2439 and their website address is www.docexpress.com.

Section 103 of the Standard Specifications for Highway Construction, Edition of 2014, is hereby amended as follows.

The first sentence of **Subsection 103.06(a)** is hereby deleted, and the following substituted therefore:

The Contract shall be electronically signed by the successful bidder and electronically submitted to the Program Management Division, Construction Contract Procurement Section, together with the required bonds and proof of liability insurance, within 10 business days after the notice of award has been issued.

Subsection 103.08(d)(3)d. is hereby deleted, and the following substituted therefore:

Documentation of the bidder's commitment to use a DBE subcontractor whose participation it submits to meet a contract goal; and

Subsection 103.08(d)(3)e. is hereby deleted, and the following substituted therefore:

Document confirmation from the DBE that it is participating in the contract as provided in the Contractor's commitment.

Subsection 103.08(d)(5) is hereby deleted, and the following substituted therefore:

The preceding information shall be submitted directly to the Arkansas Department of Transportation, Program Management Division, via Doc Express.

ARKANSAS DEPARTMENT OF TRANSPORTATION

SPECIAL PROVISION

JOB NO. A80035

MANDATORY ELECTRONIC DOCUMENT SUBMITTAL

Paper Document Submittals will not be accepted.

The Department will only accept electronically-submitted documents for consideration on this project. All correspondence and submittals to the Department shall be submitted through Doc Express, a paperless contracting system. When signed originals are required, the original shall be the document uploaded to Doc Express and the signature shall be the electronic signature applied through Doc Express. The Contractor shall use the same organizational account for project documentation as used to fulfill the requirements of the Mandatory Electronic Contract Special Provision. The toll-free phone number for Doc Express is 1-888-352-2439 and their website address is www.docexpress.com.

Any reference in the Standard Specifications to document submittal in writing or by U.S. Mail, facsimile, or in person is hereby amended to require that such documents be submitted using Doc Express with the following exceptions:

- Material delivery tickets which are used for payment or for field verification shall be submitted on paper as required by the Standard Specifications for Highway Construction, Edition of 2014.
- Any document with specific submittal requirements in state and/or federal law or federal regulations that conflict with the requirements of this Special Provision shall be submitted in accordance with such state and/or federal law or federal regulations.

A user guide is available on the Department's web page to assist Contractors with the use of Doc Express. The "Contractor Guide to Using Doc Express" is available on the Department's web page at <https://ardot.gov/divisions/construction/doc-express/>.

The Contractor may provide access for subcontractors to view and submit items in Doc Express by following the instructions provided in the "Contractor Guide to Using Doc Express". Once an organizational account is activated and the Contractor provides access to the contract, a subcontractor may submit documents to the Contractor in Doc Express by uploading the electronic documents as directed in the User Guide. Any documents uploaded by the subcontractor must be then retrieved and published by the Contractor within Doc Express for further action by the Engineer. The Engineer will not review or take any actions on any documents submitted by the subcontractor until the document has been appropriately submitted by the Contractor.

Any submittals, documents, subcontracts, proposals, working drawings, or any other items submitted by the Contractor within Doc Express are not considered approved by the Engineer until written notification of the approval is published by the Engineer in the "CON-Correspondence-From Department to Contractor" drawer in Doc Express. Any action taken by the Contractor prior to this notification is taken at the Contractor's own risk.

The Department's System Administration team has no authority to take action on any documents submitted to the system. Access for this team is for management of the application only. Knowledge of any document submitted is not imputed to the Department by the knowledge of Systems Administration.

The requirements of this Special Provision shall supersede the requirements of all other Special Provisions unless such Special Provision includes a stated exception to this Special Provision.

ARKANSAS DEPARTMENT OF TRANSPORTATION**SPECIAL PROVISION****JOB NO. A80035****LIQUIDATED DAMAGES PROCEDURE FOR BID LETTINGS**

Department Standard Specification **Section 102.04** and **Supplemental Specification 102-2** state that the Department reserves the right to refuse to issue, accept, or consider a proposal:

“If the prospective bidder is the Contractor on a current Contract with the Commission on which Liquidated Damages are being assessed, and there are no pending time extensions warranted to remove the project from Liquidated Damages.”

If the prospective bidder goes into liquidated damages on a current Contract with the Commission during the advertisement period for a letting, the Contractor will be notified seven business days prior to the letting that they will not be allowed to bid in the upcoming letting. This notification will be officially transmitted through Doc Express for the project in liquidated damages and via email.

Upon notification that they will not be allowed to bid in the upcoming letting, the Contractor will be provided an opportunity to request a reconsideration of this decision. This request must be transmitted in the form of a letter through Doc Express and via email to the Department for review within two (2) business days of receipt. The Department will review the reconsideration request and render a decision no later than the Friday prior to the letting.

Please note, a bid may be withdrawn at any time prior to the time specified for the bid letting. If a Contractor has been notified that they will not be allowed to bid, and they do not withdraw their bid, the bid will be considered invalid and rejected.

ARKANSAS DEPARTMENT OF TRANSPORTATION

SPECIAL PROVISION

JOB NO. A80035

AGGREGATE SURFACE COURSE

DESCRIPTION: This item shall consist of furnishing and placing Aggregate Surface Course (Class D-8) to be placed as shoulder gravel as shown on the plans or as directed by the Engineer.

MATERIALS: This material shall consist of a natural or manufactured mixture of gravel and soil mortar uniformly well graded from coarse to fine and so proportioned as to meet all the requirements hereinafter specified. The aggregate shall consist of crushed or uncrushed hard gravel or crushed stone or a combination of crushed and uncrushed material. The material furnished shall not contain more than 15% by weight of shale, slate, and other objectionable, deleterious or other injurious matters.

GRADING REQUIREMENTS

Class D-8

<u>Sieve</u>	<u>Percent Passing</u>
2"	100
3/4"	50 to 100
#4	25 to 65
#40	10 to 40
#200	3 to 30
Maximum Plasticity Index	20

The removal of oversize aggregate by hand methods, such as raking or forking, will not be permitted. Quality control and acceptance sampling shall be performed in accordance with Section 306 of the 2014 Standard Specifications, except that no density testing will be required.

CONSTRUCTION REQUIREMENTS: Construction shall conform to subsection 303.03 of the 2014 Standard Specifications except as noted in the plans.

METHOD OF MEASUREMENT: Work performed and material accepted under this item will be measured by the ton in vehicles, in accordance with Section 109.

BASIS OF PAYMENT: Work performed under this item and measured as provided above will be paid for at the contract unit price bid per ton which price shall be full compensation for preparing the subgrade; furnishing material; for loading, hauling, and the delivery to the work site; for spreading, finishing, watering, manipulating, and compacting; for performing quality control and acceptance sampling and testing; and for all labor, tools, equipment, and incidentals necessary to complete the work.

Payment will be made under:

PAY ITEM	PAY UNIT
Aggregate Surface Course (Class D-8)	Ton

ARKANSAS DEPARTMENT OF TRANSPORTATION

SPECIAL PROVISION

JOB NO. A80035

DESIGN AND QUALITY CONTROL OF ASPHALT MIXTURES

Section 400 of the Standard Specifications for Highway Construction, Edition of 2014, is hereby amended as follows:

The eighth (8th) and tenth (10th) bullet within the first paragraph of **Subsection 404.01, Design of Asphalt Mixtures. (a) General** is hereby deleted and the following added:

- A one-gallon sample of performance grade asphalt binder to be used in all Section 405 Asphalt Concrete Hot Mix Base Course and Section 406 Asphalt Concrete Hot Mix Binder Course mix designs.
- Nine (9) blended aggregate samples for all Section 405 Asphalt Concrete Hot Mix Base Course and Section 406 Asphalt Concrete Hot Mix Binder Course mix designs.
- A two-gallon sample of performance grade asphalt binder to be used in all Section 407 Asphalt Concrete Hot Mix Surface Course mix designs.
- Fourteen (14) blended aggregate samples for all Section 407 Asphalt Concrete Hot Mix Surface Course mix designs.

The last sentence of the last paragraph of **Subsection 404.01 Design of Asphalt Mixtures. (a) General** is hereby deleted and the following substituted therefor:

At least fifteen (15) business days shall be allowed for the review of the mix design.

ARKANSAS DEPARTMENT OF TRANSPORTATION**SPECIAL PROVISION****JOB NO. A80035****PERCENT AIR VOIDS AND NDESIGN FOR ACHM SURFACE MIX DESIGNS**

Supplemental Specification 400-5, Percent Air Voids for ACHM Mix Designs, is hereby amended as follows:

The fourth sentence of the first paragraph of **Subsection 404.01(b), Design Requirements**, is hereby deleted and the following substituted therefor:

The optimum asphalt content is the asphalt binder content at 4.0% air voids for ACHM Base and ACHM Binder Courses. The optimum asphalt content is the asphalt binder content at 3.5% air voids for ACHM Surface Courses.

The first bullet of the first paragraph of **Subsection 404.01(b), Design Requirements**, is hereby deleted and the following substituted therefor:

- All binder grades for ACHM Base and Binder Courses will be designed using 4.0% air voids and all binder grades for ACHM Surface Courses will be designed using 3.5% air voids.

The second paragraph of **Subsection 404.01(b), Design Requirements**, of the Standard Specifications, is hereby amended and the following added:

All ACHM Surface Courses will be designed at N_{des} of 60 gyrations.

The second sentence of the second paragraph of **Subsection 404.04, Quality Control of Asphalt Mixtures**, is hereby deleted and the following substituted therefor:

Adjustments to the accepted mix design to conform to actual production values without redesign of the mixture shall be based on production of the mixture at a target value of 4.0% air voids in ACHM Base and Binder Courses specimens and an asphalt binder content not less than that specified in the accepted mix design.

Adjustments to the accepted mix design to conform to actual production values without redesign of the mixture shall be based on production of the mixture at a target value of 3.5% air voids in ACHM Surface Course specimens and an asphalt binder content not less than that specified in the accepted mix design.

ARKANSAS DEPARTMENT OF TRANSPORTATION

SPECIAL PROVISION

JOB NO. A80035

PERCENT AIR VOIDS AND NDESIGN FOR ACHM SURFACE MIX DESIGNS

Table 407--1 and Table 407--2 of **Subsection 407.04, Construction Requirements and Acceptance**, are hereby deleted and the following substituted therefor:

Table 407-1

Design Requirements for Asphalt Concrete Hot/Warm Mix Surface Course
(1/2" [12.5 mm])

Control Points	
Sieve (mm)	Percent Passing (%)
3/4" (19.0)	100
1/2" (12.5)	90 - 100
3/8" (9.5)	90 max.
No. 8 (2.36)	28 - 58
No. 16 (1.18)	-
No. 30 (0.60)	-
No. 50 (0.30)	-
No. 200 (0.075)	3 - 7

Asphalt Binder Content	Design Value	
% Air Voids	3.5	
% VMA	14.5 – 16.0	
Minimum Water Sensitivity Ratio	80.0	
% Anti-strip	As Required	
Fines to Asphalt Ratio*	0.6 – 1.2	
Wheel Tracking Test	<u>Design PG Grade</u>	<u>Maximum Rut</u>
(8000 Cycles, 100 psi, 64° C)	64-22 or 67-22	0.315 in. (8.000 mm)
	70-22 or 76-22	0.197 in. (5.000 mm)

*Fines to asphalt ratio shall be defined as the percent materials passing the No. 200 (0.075 mm) sieve (expressed as a percent of total aggregate weight) divided by the effective asphalt binder content.

ARKANSAS DEPARTMENT OF TRANSPORTATION

SPECIAL PROVISION

JOB NO. A80035

PERCENT AIR VOIDS AND NDESIGN FOR ACHM SURFACE MIX DESIGNS

Table 407-2

Design Requirements for Asphalt Concrete Hot/Warm Mix Surface Course
(3/8" [9.5 mm])

	Control Points	
Sieve (mm)	Percent Passing (%)	
½" (12.5)	100	
3/8" (9.5)	90 - 100	
No. 4 (4.75)	90 max.	
No. 8 (2.36)	32 - 67	
No. 16 (1.18)	-	
No. 30 (0.60)	-	
No. 50 (0.30)	-	
No. 200 (0.075)	3 - 7	
Asphalt Binder Content	Design Value	
% Air Voids	3.5	
% VMA	15.5 – 17.0	
Minimum Water Sensitivity Ratio	80.0	
% Anti-strip	As Required	
Fines to Asphalt Ratio*	0.6 – 1.2	
Wheel Tracking Test	<u>Design PG Grade</u>	<u>Maximum Rut</u>
(8000 Cycles, 100 psi, 64° C)	64-22 or 67-22	0.315 in. (8.000 mm)
	70-22 or 76-22	0.197 in. (5.000 mm)

*Fines to asphalt ratio shall be defined as the percent materials passing the No. 200 (0.075 mm) sieve (expressed as a percent of total aggregate weight) divided by the effective asphalt binder content.

ARKANSAS DEPARTMENT OF TRANSPORTATION

SPECIAL PROVISION

JOB NO. A80035

PERCENT AIR VOIDS AND NDESIGN FOR ACHM SURFACE MIX DESIGNS

The Table 410-1 in **Subsection 410.09(b)**, **Acceptance of the Pavement**, of the Standard Specifications, is hereby amended as follows for ACHM Surface Courses:

**TABLE 410-1
COMPLIANCE, PRICE REDUCTION AND REJECTION LIMITS FOR ACHM SURFACE COURSES**

Property	Compliance Limits	Price Reduction Limits	Lot Rejection Limits	Sublot Rejection Limits
Asphalt Binder Content	±0.3 from mix design value	more than ±0.3 from mix design value	more than ±0.6 from mix design value	±0.8 from mix design value
Air voids (AV)	2.5% to 4.5%	1.9% to 2.4% 4.6% to 5.0%	1.8% or less 5.1% or more	1.4% or less 5.6% or more
Voids in Mineral Aggregate (VMA)* ACHM Surface Course (1/2" [12.5 mm]) ACHM Surface Course (3/8" [9.5 mm])	14.0% to 16.5% 15.0% to 17.5%	13.5% to 13.9% 16.6% to 17.0%	13.4% or less 17.1% or more	12.9% or less 17.6% or more
Density (% of theoretical)	94.0% ± 2.0%	91.0% to 91.9% 96.1 to 97.0%	14.4% or less 18.1% or more	13.9% or less 18.6% or more
Density (% of theoretical) where minimum specified is 90.0%	90.0% to 96.0%	89.0% to 89.9% 96.1% to 97.0%	90.9% or less 97.1% or more	89.9% or less** 98.1% or more

*The values for VMA_(actual) shall be determined by calculating the VMA_(effective) and reducing it by the correction factor shown on the mix design.
**Subject to further evaluation, see text.

ARKANSAS DEPARTMENT OF TRANSPORTATION

SPECIAL PROVISION

JOB NO. A80035

LONGITUDINAL JOINT DENSITIES FOR ACHM SURFACE COURSES

DIVISION 400 ASPHALT PAVEMENTS of the Standard Specifications, Edition of 2014, is hereby amended as follows:

The following is added after the first paragraph of **Subsection 407.04 Construction**:

Joint densities shall be measured directly on, and centered over, the visible joint for butt joints or centered over the wedge for joints constructed using a notched wedge paver attachment. The joint density core samples shall be 6" diameter and should be cut while the lane closure for the paving operation is still in place in order to provide proper traffic control for the coring operation. If the Contractor is unable to cut the cores while the lane closure is still in place, the coring operation must be performed using either a static or moving lane closure as detailed in the plans or MUTCD, and in accordance with any limitations contained in the Contract. The required joint density shall be 89% to 96% of the maximum theoretical density.

The third paragraph of **Subsection 410.07, Spreading and Finishing**, is hereby deleted and the following is substituted therefor:

The longitudinal joint in one layer shall offset that in the layer immediately below by approximately 6" (150 mm), if possible; however, in general, the joint in the top layer shall be at the centerline of the pavement if the roadway comprises two lanes in width, or at lane lines if the roadway is more than two lanes in width. On roadways with a center turn lane, the Contractor may, at his option, elect to place a joint at the crown (i.e., middle of the center turn lane) of the roadway and eliminate the joints on the lane lines of that lane. The slight excess of asphalt at a longitudinal joint, generated by overlapping during placement of an adjacent mat to a previous mat, shall not be scattered across the mat.

The following is added after the last paragraph of **Subsection 410.08 Rolling and Density Requirements and Joints**:

When the material forming the two sides of a longitudinal joint comes from two different sublots, the theoretical maximum density used as a basis for density calculations shall be the average of the theoretical maximum density for the two sublots.

The following is added after the second sentence of the second paragraph of **Subsection 410.09 Acceptance of the Pavement and Adjustments in Payment, (a) General** is expanded to include the following:

For longitudinal joint density testing, the standard lot size for acceptance and adjustment in payment will be 12,000 linear feet (3600 meters), with each standard lot divided into four sublots of 3,000 linear feet (900 meters) each. These lengths will apply only to ACHM Final Surface Course areas in which both sides of the longitudinal joint have been formed, including the joints between the travel lanes and acceleration or deceleration lanes, but excluding the longitudinal joint between a shoulder and travel lane which will not be subject to this testing. For longitudinal joint density tests, partial

ARKANSAS DEPARTMENT OF TRANSPORTATION

SPECIAL PROVISION

JOB NO. A80035

LONGITUDINAL JOINT DENSITIES FOR ACHM SURFACE COURSES

lots normally will be not less than 1,200 linear feet (360 meters) nor more than 13,200 linear feet (4000 meters). Cores for ACHM Intermediate Surface shall be cut and tested for density at locations where acceptance cores have been sampled. Results will not be used for Acceptance and Adjustments in Payment but shall be submitted to Department for informational purposes only.

The following is added after the last sentence of the second paragraph of **Subsection 410.09, Acceptance of the Pavement and Adjustments in Payment, (a) General**:

Field density tests on longitudinal joints shall be performed directly on the joint as soon as possible after placement of the hot lane. The core should be cut while the lane closure for the paving operation is still in place in order to provide proper traffic control for the coring operation. If the Contractor is unable to cut the cores while the lane closure is still in place, the coring operation must be performed using either a static or moving lane closure as detailed in the plans or MUTCD, and in accordance with any limitations contained in the Contract.

The first and second sentences of the third paragraph of **Subsection 410.09, Acceptance of the Pavement and Adjustments in Payment, (a) General** is hereby deleted and the following substituted therefor:

The Contractor shall obtain and test one sample taken at random from each subplot, including for longitudinal joint density testing. The Department will determine the location for each sample in the subplot by ARDOT Test Method 465.

Subsection 410.09 Acceptance of the Pavement and Adjustments in Payment, (b) Acceptance of the Pavement is hereby modified as follows:

The following is added as the second bullet following the first paragraph:

- The results of tests for the longitudinal joint density in Table 410-2

The following is added after the last paragraph of **Subsection 410.09(b)(1)**:

Acceptance for Longitudinal Joint Density as shown in Table 410-2 will be by lot. Acceptance of a standard longitudinal joint density lot will be based on the average of the five (5) tests performed on the lot. Acceptance of a partial lot will be based on the average of the actual number of tests made on that partial lot.

Incentives or disincentives will be added or deducted from the payment made for each acceptance lot for Longitudinal Joint Density according to Table 410-2.

In addition to the disincentives provided within the table, any lot with density results which average below 88% shall be sealed at no cost to the Department. The entire length of the longitudinal joint within the lot shall be sealed with PG 64-22 asphalt cement. The asphalt cement sealant shall be heated and maintained between 265°F and

ARKANSAS DEPARTMENT OF TRANSPORTATION

SPECIAL PROVISION

JOB NO. A80035

LONGITUDINAL JOINT DENSITIES FOR ACHM SURFACE COURSES

320°F. The sealant shall not be placed if the air temperature is below 40°F, unless otherwise permitted by the Engineer. The joint area of the pavement surface must be clean, dry, and free of any loose material and debris. Cleaning with a power broom may be required. Utilize a pressure applicator with a wand or nozzle capable of applying hot asphalt sealant in a straight and consistent width of 4 inches ±1 inch and thickness of 1/16 inch ± 1/32 inch at specified temperature range and at a minimum rate of 0.013 gallons/linear foot. The center of the sealant band should be placed within 1 inch of the joint. Immediately level high spots with a squeegee or wand. Remove and dispose of excess sealant at no cost to the Department. Re-seal areas of the joint that are inconsistently or not completely covered. Any pavement markings marred by the sealing operation will be replaced at no additional cost to the Department.

TABLE 410-2
LONGITUDINAL JOINT DENSITY DISINCENTIVE

% Gmm		
Min.	Max.	\$/L.F./Lot
98.0	100	-1.00
97.0	<98	-0.70
96.0	<97	-0.42
95.0	<96	+1.00
94.0	<95	+0.98
93.0	<94	+0.77
92.0	<93	+0.42
91.0	<92	0.00
90.0	<91	0.00
89.0	<90	0.00
88.0	<89	-0.42
87.0	<88	-0.77
86.0	<87	-0.98
	<86	-1.00

ARKANSAS DEPARTMENT OF TRANSPORTATION

SPECIAL PROVISION

JOB NO. A80035

SUBMISSION OF ASPHALT CONCRETE HOT MIX ACCEPTANCE TEST RESULTS

Division 106 of the Standard Specifications for Highway Construction, Edition of 2014, is hereby amended as follows:

The following is hereby added to **Subsection 106.04, Acceptance of Materials**:

All ACHM Contractor Acceptance Tests shall be submitted electronically by use of the ACHM Microsoft Excel Spreadsheet for Contractors/Suppliers and on paper.

The ACHM Microsoft Excel Spreadsheet for Contractors/Suppliers can be downloaded from the following website:

<https://www.ardot.gov/divisions/construction/construction-information/contractor-achm-workbook/>.

To download this file and the supporting documentation, follow the instructions on the page linked above.

Use of this file requires Microsoft Excel 2000, 2003, or 2007.

The preferred method of transmitting the file is to e-mail the completed ACHM Microsoft Excel Spreadsheet for Contractors/Suppliers to the Department's ACHM Plant Inspector assigned to the project. It is also acceptable to transmit the file by Compact Disk (CD) or other electronic device. Regardless of the method of transmission used, the signed paper acceptance tests must be provided to the Resident Engineer via the required Document Submission system required by the Contract (Doc Express or eBuilder).

Any questions or issues arising from the use of this file should be referred to the Resident Engineer.

ARKANSAS DEPARTMENT OF TRANSPORTATION

SPECIAL PROVISION

JOB NO. A80035

PRICE ADJUSTMENT FOR ASPHALT BINDER

A price adjustment clause is included in this Contract to provide additional compensation to the Contractor or a credit to the Department for fluctuations in asphalt binder prices. This price adjustment is dependent upon a change in the average price of asphalt binder which results in an increase or decrease in the price of products utilized on this project.

Payment. Payment will be made to the Contractor for monthly fluctuation in the price of asphalt binder used in performing the applicable items of Asphalt Concrete Hot Mix and Ultrathin Bonded Wearing Course work as listed in the table below when the asphalt binder price fluctuates from the base price defined below. Payment may be positive, negative, or nonexistent depending on the circumstances. Payments or deductions for the asphalt binder price adjustment will be included in the Contractors current estimates, and the payment or deduction authorized for each estimate will be based upon the quantities for applicable items of work.

The Asphalt Binder Price Adjustment will be a dollar amount paid as compensation to the Contractor, or as a credit to the Department as reflected on the Current (or Final) Estimate Summary Report as Payment Adjustments.

Asphalt Binder Price Adjustment (ABPA). The Asphalt Binder Price Adjustment (ABPA) for the current estimate will be computed according to the following formula:

$$ABPA = Q \times D \times (IQP / 100)$$

Where

- ABPA = Asphalt binder price adjustment, in dollars;
- Q = Quantities paid for the applicable items on the current estimate; tons of mix for ACHM items or square yards for Ultrathin Bonded Wearing Course
- D = Allowable price differential, in dollars;
- IQP = Item Quantity Percent, Quantity of Indexed Material per unit of the applicable item on the current estimate.

The above formula will be applied to each individual payment of the applicable item. When the Current (or Final) estimate is generated, the sum of these individual adjustments will be included as a Payment Adjustment.

Applicable Items of Work		
ITEM OF WORK	SPECIFICATION NUMBER	ITEM QUANTITY PERCENT
Asphalt Binder in ACHM Base Course	405	100
Asphalt Binder in ACHM Binder Course	406	100
Asphalt Binder in ACHM Surface Course	407	100
Ultrathin Bonded Wearing Course (Type B)	SP	5.5
Ultrathin Bonded Wearing Course (Type C)	SP	5.4

ARKANSAS DEPARTMENT OF TRANSPORTATION

SPECIAL PROVISION

JOB NO. A80035

PRICE ADJUSTMENT FOR ASPHALT BINDER

The terms of this Special Provision will apply only to the items listed in this Special Provision table above. No other items on the contract will be subject to the terms of this Special Provision.

The allowable price differential, "D", for the current estimate will be computed according to the following formula, using the appropriate binder grades:

$$D = P - P(b)$$

P, the asphalt binder current price in dollars per ton, is the Monthly Asphalt Binder Price Index for the month in which the payment entry is entered.

P(b), the asphalt binder base price in dollars per ton, is the Monthly Asphalt Binder Price Index for the month in which the bids for the work were received.

Asphalt Binder Index Determination.

PG64-22 Binders. The Monthly Asphalt Binder Price Index for PG64-22 binders will be determined by calculating the average for performance-graded binder using the Selling Price of PG 64-22 paving grade. The monthly asphalt binder price will be an average of five asphalt binder prices. The prices will be furnished by the four largest asphalt binder suppliers in the State of Arkansas as determined by the previous calendar year. For an asphalt supplier to be included in the asphalt binder price index they must supply at least ten percent of the asphalt binder in Arkansas. The final component in the asphalt binder price index will be the Asphalt Weekly Monitor® furnished by Poten & Partners, Inc. The issue of the Asphalt Weekly Monitor® used will be for the last full week in the previous month received by the Department prior to the first day of the index month. The four largest suppliers included in the asphalt binder price index shall furnish the Department with their average price on the Thursday before the Friday of the last full week of the month. If any supplier fails to submit a price by this deadline, that supplier's price will not be included in the asphalt binder price index for that month.

PG70-22 and PG76-22 Binders (including Asphalt Binder in Ultrathin Bonded Wearing Course). The monthly Asphalt Binder Price Index for PG70-22 and PG76-22 binders (including asphalt binder in Ultrathin Bonded Wearing Course) will be determined by the same method above, except that the price from the Asphalt Weekly Monitor® will not be used in the calculation of the monthly average binder price. The monthly asphalt binder price for PG70-22 and PG76-22 binders will be calculated using the average of the prices supplied by the four largest binder suppliers in the State for those grades.

Supplemental Items Subject to Adjustment. Items included in the contract that are listed in the table above are subject to adjustment in accordance with this provision, regardless of any amount of overrun to the plan quantity. Any new items of work added to the Contract by supplemental agreement that are listed in the table above will be subject to the asphalt binder price adjustments in accordance with this provision. The base asphalt binder price, P(b), for any newly added eligible items will be the same P(b) as the eligible items in the Contract, and the new unit price established by supplemental agreement will be determined accordingly.

06-03-2015
10-02-2015 Rev.,11-16-2017 Rev.,
12-06-2018 Rev.,02-25-2021 Rev.,
04-13-2022 Rev.,01-12-2023 Rev.,
02-29-2024 Rev.

Page 3 of 3

ARKANSAS DEPARTMENT OF TRANSPORTATION

SPECIAL PROVISION

JOB NO. A80035

PRICE ADJUSTMENT FOR ASPHALT BINDER

Viewing Asphalt Binder Price Index. Historical asphalt binder price index values will be available in the "Asphalt Binder Index Report" document located on the ARDOT website at <https://ardot.gov/divisions/construction/construction-information/> under Asphalt Binder Information.

08/14/2020

ARKANSAS DEPARTMENT OF TRANSPORTATION

SPECIAL PROVISION

JOB NO. A80035

HIGH PERFORMANCE COLD MIX

Description: This item shall consist of an asphalt concrete material composed of mineral aggregate, asphalt binder, and additives for use in patching to maintain traffic.

Materials: Materials furnished must meet the requirements of Specifications for QPR Pavement Repair, UPM, ProLine All Weather Mix, Ergon RM-90, or equal.

Materials supplied under this specification will be accepted on receipt and approval of a certification prepared and signed by the Contractor indicating the material complies with the requirements of this specification.

The mixture shall be capable of stockpiling for not less than one year, and when taken from a stockpile, shall be capable of being shoveled, raked, spread and compacted.

The Department reserves the right to sample and test any materials produced under this specification and to reject any material which does not meet the requirements of the specification. Rejected material shall be replaced or otherwise removed at the expense of the Contractor.

The Contractor will be responsible for manufacturing the High Performance Cold Mix in a hot mix asphalt plant, furnishing the aggregate, liquid asphalt and mix design.

Construction Requirements: Construction requirements shall conform, insofar as possible, to Section 415 of the ARDOT's Standard Specifications for Highway Construction, Edition of 2014.

METHOD OF MEASUREMENT: High Performance Cold Mix will be measured by the ton of mix based upon truck scale weights.

The Contractor's scale printout will be used to certify the weight of mix produced. Final weights of mix may be subject to verification.

BASIS OF PAYMENT: Work completed and accepted and measured as provided above, will be paid for at the contract unit price bid per ton for High Performance Cold Mix, which price shall be full compensation for liquid asphalt; for asphalt hot plant mixing; and for all labor, equipment, tools and incidentals necessary to complete the work.

Payment will be made under:

PAY ITEM	PAY UNIT
Asphalt Concrete Patching For Maintenance of Traffic	Ton

ARKANSAS DEPARTMENT OF TRANSPORTATION

SPECIAL PROVISION

JOB NO. A80035

DESIGN OF ASPHALT MIXTURES-AGGREGATES

Section 400 of the Standard Specifications for Highway Construction, Edition of 2014, is hereby amended as follows:

The following is added to the fifth sentence of the first paragraph in the bulleted section of **Subsection 404.01 Design of Asphalt Mixtures. (b) Design Requirements:**

- Limestone aggregate will be required as a part of the mix design for this project. The minimum requirement for limestone in the coarse aggregate shall be 20% by weight of the overall amount of the cold feed.

ARKANSAS DEPARTMENT OF TRANSPORTATION

SPECIAL PROVISION

JOB NO. A80035

PRICE ADJUSTMENT FOR FUEL

A price adjustment clause is included in this Contract to provide additional compensation to the Contractor or a credit to the Department for fluctuations in diesel fuel prices. This price adjustment is dependent upon a change in the average price of fuel which results in an increase or decrease in the price of products utilized on this project. For the purposes of this specification, it is assumed that all fuel used is diesel fuel and that the fuel use factors shown in the table below cover all fuel used in delivery to the plant, production, hauling to the job site, placement, and finishing of the items of work shown.

Payment. Payment will be made to the Contractor for monthly fluctuation in the price of diesel fuel used in performing the applicable items as listed in the table below when the diesel fuel price fluctuates from the base price defined below. Payments may be positive, negative, or nonexistent depending on the circumstances. Payments or deductions for the fuel price adjustment will be included in the Contractor's current estimates, and the payment or deduction authorized for each estimate will be based upon the quantities for applicable items of work. Subcontracts should include the payment or deduction of fuel price adjustments on pay items listed in the table below when those items are included in a subcontract.

The Fuel Price Adjustment will be a dollar amount paid as compensation to the Contractor, or as a credit to the Department as reflected on the Current (or Final) Estimate Summary Report as Payment Adjustments.

Fuel Price Adjustment (FPA). The Fuel Price Adjustment (FPA) for the current estimate will be computed according to the following formula:

$$FPA = Q \times F \times D$$

Where

- FPA = Fuel price adjustment, in dollars;
- Q = Quantities paid for the applicable items on the current estimate,
- F = The Fuel Use Factor for the applicable items of work subject to this price adjustment, as listed in the table below,
- D = Allowable price differential, in dollars.

The above formula will be applied to each individual payment of the applicable item. When the Current (or Final) estimate is generated, the sum of these individual adjustments will be included as a Payment Adjustment.

ARKANSAS DEPARTMENT OF TRANSPORTATION

SPECIAL PROVISION

JOB NO. A80035

PRICE ADJUSTMENT FOR FUEL

Fuel Use Factors		
Item of Work	Specification Numbers	Fuel Use Factor Per Unit
Earthwork: (Unclassified Excavation, Compacted Embankment, Selected Material)	210,302	0.34 gal./C.Y.
Soil Stabilization	Special Provision	2.28 gal./ton
Shaping: (Shaping Roadway Section, Subgrade Preparation, Trenching and Shoulder Preparation, Scarifying and Recompactng Shoulders)	213,214,215,216	2.52 gal./Station
Base Course and Stone: (Stone Backfill, Aggregate Base Course, Soil Aggregate in Cement Treated Base Course, Aggregate in Cement Stabilized Crushed Stone Base Course, Mineral Aggregate in Asphalt Surface Treatment	207,303,307,308,309,310,402	0.54 gal./ton
ACHM Paving: (ACHM Base Course, ACHM Binder Course, ACHM Surface Course, Open Graded Asphalt Base Course)	405,406,407,417	2.36 gal./ton
Ultra-Thin Bonded Wearing Course (All Types)	Special Provision	2.18 gal./ton
Milling: (Cold Milling Asphalt Pavement, Grinding Portland Cement Concrete Pavement)	412, 510	0.18 gal./S.Y.
PCC Paving: (Portland Cement Concrete Base, Open Graded Portland Cement Concrete Base, Portland Cement Concrete Pavement, High Early Strength Concrete Pavement, Continuously Reinforced Concrete Pavement, Portland Cement Concrete Driveway)	309, 310,501,503,505	0.44 gal./S.Y.
Structural Concrete (Approach Slabs, Approach Gutters, Class B Concrete-Bridge, Class S Concrete-Bridge, Class S(AE) Concrete-Bridge, Seal Concrete-Bridge, Class A Concrete-Roadway, Class S Concrete-Roadway	504, 802	1.75 gal./C.Y.
Flatwork: (Concrete Ditch Paving, Concrete Islands, Concrete Walks, Wheelchair Ramps)	605,632,633,641	0.30 gal./S.Y.

ARKANSAS DEPARTMENT OF TRANSPORTATION

SPECIAL PROVISION

JOB NO. A80035

PRICE ADJUSTMENT FOR FUEL

When the units of measure in this contract for the items of work listed in the table do not correspond with the units shown in the table (i.e. Asphalt Concrete paid by the square yard, etc.), those items will not be subject to the terms of this special provision or any fuel price adjustment.

The allowable price differential, “D”, for the current estimate will be computed according to the following formula:

$$D = P - P(b)$$

P, the current fuel price in dollars per gallon, is the Monthly Fuel Price Index for the month in which the payment entry is entered.

P(b), the fuel base price in dollars per gallon, is the Monthly Fuel Price Index for the month in which the bids for the work were received.

Fuel Price Index Determination. The Monthly Fuel Price Index will be determined by using the On-Highway retail price for No. 2 Diesel Fuel – ULS (Ultra Low Sulfur), as listed for the US Gulf Coast region on the U.S. Energy Information Administration’s website. The value used will be that for either the closest Monday prior to the first calendar day of the index month or the first calendar day of the index month, if that is a Monday.

https://www.eia.gov/opensdata/qb.php?sdid=PET.EMD_EPD2DXL0_PTE_R30_DPG.W

Supplemental Items Subject to Adjustment. Items included in the contract that are listed in the table above are subject to adjustment in accordance with this provision, regardless of any amount of overrun to the plan quantity. Any new items of work added to the Contract by supplemental agreement that are listed in the table above will be subject to the fuel price adjustments in accordance with this provision. The base fuel price, P(b), for any newly added eligible items will be the same P(b) as the eligible items in the Contract, and the new unit price established by supplemental agreement will be determined accordingly.

Viewing Fuel Price Index. Historical fuel price index values will be available in the “Asphalt Binder Index Report” document located on the ARDOT website under Fuel Price Information at <https://ardot.gov/divisions/construction/construction-information/>.

Opt Out Option. The Contractor, at its own discretion, can choose to opt out of the adjustments for fuel prices determined by this special provision. If the Contractor wishes to utilize this option, an authorized representative of the firm must sign the form on Page 4 of this special provision and submit it to the Department at PMD@ardot.gov prior to the time and date of the bid letting for this project. This representative must currently be listed with the Department as an officer approved to sign contracts in the firm’s name.

ARKANSAS DEPARTMENT OF TRANSPORTATION

SPECIAL PROVISION

JOB NO. A80035

PRICE ADJUSTMENT FOR FUEL

OPT OUT OF PRICE ADJUSTMENTS TO FUEL

As an authorized representative of this company, I hereby choose the option to opt out of the price adjustments for fuel for all pay items allowable by this special provision for this contract. By signature of this form, my firm waives all payment adjustments for fuel indexing for the duration of this project and waives any subsequent appeals for additional compensation for fuel price fluctuations.

This action only applies to the construction contract for the job number listed in the header of this document.

Printed Name: _____ Title: _____

Signature: _____ Date: _____

Company Name: _____

NOTE: To opt out, this completed form must be submitted to the Department at PMD@ardot.gov prior to the time and date of the bid letting for this project.

ARKANSAS DEPARTMENT OF TRANSPORTATION

SPECIAL PROVISION

JOB NO. A80035

BROADBAND INTERNET SERVICE FOR ASPHALT CONCRETE PLANT

Section 409.03(h) of the Standard Specifications for Highway Construction, Edition of 2014, is hereby amended as follows:

The following bullet is added under detailed requirements:

- Broadband Internet Service shall be provided.

The Broadband Internet Service shall be provided with an Internet Protocol (IP) address which is reachable on the global Internet (public) and which is permanently assigned (static). The Contractor is not required to provide this service if an IP address which is both static and public is not available.

If this service is not available at the beginning of a project but becomes available during the life of the project, the Contractor shall provide the service immediately from the date of availability.

The data transfer rate shall be 3 megabits per second (Mbps) download and 500 kilobits per second (kbps) upload, or higher, with latency not to exceed 150 milliseconds. If the Broadband Internet Service meets all of the requirements of this specification except for the data transfer rate and/or latency, then the best performing available connection shall be provided.

Prior to the selection of the Broadband Internet Service provider, the Contractor shall submit to the Resident Engineer, in writing, the proposed method for providing Broadband Internet Service. The Resident Engineer shall review this submittal and respond in writing regarding the acceptability of the proposed method.

The Broadband Internet Service shall be provided with equipment providing one Ethernet port.

ARKANSAS DEPARTMENT OF TRANSPORTATION

SPECIAL PROVISION

JOB NO. A80035

WARM MIX ASPHALT

DESCRIPTION: The Department will allow the use of Warm Mix Asphalt (WMA). All provisions for the production and placement of conventional HMA mixtures as stipulated in Section 410 Construction Requirements and Acceptance of Asphalt Concrete Plant Mix Courses of the Standard Specifications for Highway Construction, Edition 2014, are applicable except as noted below.

Section 410 Construction Requirements and Acceptance of Asphalt Concrete Plant Mix Courses of the Standard Specifications for Highway Construction, Edition of 2014, is hereby amended as follows:

Section 410.03: Replace the third sentence with “WMA production temperatures at the plant shall be according to the Contractor’s approved mix design but may be adjusted based on recommendations of the WMA additive/process manufacturer.”

Add the following paragraph: “Implementation of best management practices in the control of aggregate moisture content prior to introduction to the drying or mixing drum is highly recommended in order to achieve the maximum benefit of WMA technology.”

Section 410.07: Replace the last sentence of the first paragraph with “Spreading and finishing temperatures shall be according to the Contractor’s approved mix design, but in no case shall the WMA be placed at a temperature less than 220° F.”

ARKANSAS DEPARTMENT OF TRANSPORTATION

SPECIAL PROVISION

JOB NO. A80035

COLD MILLING - MILL & INLAY

Section 412 of the Standard Specifications for Highway Construction, Edition of 2014, is hereby amended as follows:

The following is added following the last paragraph of **Subsection 412.03 Construction Requirements**:

To promote and maximize future economic and environmental benefits of recycled asphalt materials, when the item "Cold Milling Asphalt Pavement" is included in a project the Contractor may elect to stockpile and retain a portion of the reclaimed asphalt pavement (RAP) material for use or replacement of material used on this project or for other current or future ARDOT projects. Unless the plans designate the Contractor will receive more, the maximum portion available for the Contractor shall not exceed 85% of the millings which will be generated from this project.

At least ten business days prior to beginning the cold milling operations, the Contractor shall submit a written request to retain a portion of the reclaimed pavement when it is to remain the property of the Department. This request shall be in accordance with one of the following options:

1. Prior to beginning cold milling operations, the Contractor shall notify the Engineer when the reclaimed pavement is being hauled to the asphalt plant for stockpiling and of the designated location of the stockpile at the plant. The Contractor shall weigh each load of Department reclaimed pavement hauled to the asphalt plant in accordance with Subsection 109.01(f) of the Standard Specifications and provide copies of the weigh tickets to the Engineer by the next business day. The total tonnage that may be retained by the contractor shall be based on 85% of the calculated weight of the total area and depth of milling shown in the plans. On the day that the total retained tonnage is expected to be reached, the Engineer shall determine the number of loads remaining that may be retained and hauled to the Contractor's stockpile. The Engineer shall determine when the Contractor's portion has been reached, regardless of whether the total weighed tonnage is above or below the 85%.
2. The Engineer may designate a specific area of the roadway where the reclaimed pavement material can be retained by the Contractor. This area shall be approximately 85% of the total plan quantity shown for Cold Milling Asphalt Pavement. The Engineer shall take into account the designated location in relation to the Contractor's stockpile location and shall make every effort, in as much as possible, to minimize haul distances. The Contractor may request consideration of specific locations to be retained; however, the final location will be determined by the Engineer.

Only one option above may be requested per project and will be the method used throughout the project. The quantities for either option may be increased or decreased appropriately as the result of a plan quantity that have been revised by an approved change order. Any pavement material removed as part of corrective work by the Contractor shall remain the property of the Contractor.

ARKANSAS DEPARTMENT OF TRANSPORTATION

SPECIAL PROVISION

JOB NO. A80035

COLD MILLING - MILL & INLAY

The contractor shall stockpile a portion of the millings generated on the project for the county in which the project is located or an adjoining county. The amount of material to be stockpiled for the county will be an equivalent amount to that which would be generated by tapered milling or butt joints for the beginning and end of the project, tapers or butt joints at any bridge structures on the projects, and tapers or butt joints at adjoining county roads, city streets, or other highways. The locations and quantity that will be stockpiled for the county will be designated on the plans or provided by the Engineer. The material designated for the county shall be transported and stockpiled at the location(s) shown in the plans.

Unless otherwise shown on the plans, the remaining material generated from the cold milling operations shall be the property of the Department and shall be transported and stockpiled at the location shown on the plans.

The millings shall be stockpiled in a trapezoidal shape, or as directed by the Engineer, which can be easily measured. No direct payment will be made for loading, hauling, and stockpiling of the milled material. Full payment will be considered included in the unit price bid for Cold Milling Asphalt Pavement.

ARKANSAS DEPARTMENT OF TRANSPORTATION

SPECIAL PROVISION

JOB NO. A80035

RUMBLE STRIPS

Section 642 Rumble Strips of the Standard Specifications for Highway Construction, Edition of 2014, is hereby expanded to include the items Centerline Rumble Stripes in Asphalt Roadways, Rumble Stripes in Asphalt Shoulders, and Rumble Stripes in Portland Cement Concrete Shoulders.

Subsection 642.01 Description is hereby deleted and the following substituted therefore:

642.01 Description. This item shall consist of constructing rumble strips and rumble stripes on the centerline of asphalt roadways, on asphalt shoulders, and on Portland cement concrete shoulders according to these specifications and conforming to the details shown on the plans.

For the purpose of this special provision, rumble strips and rumble stripes will all be referred to as rumble strips.

Permanent pavement markings are not included in the price bid for rumble strips and shall be installed and paid for per the Standard Specifications.

The last sentence of Subsection 642.02 Equipment is hereby deleted and the following substituted therefore:

The cutting head(s) shall be suspended from the power unit in a manner that will allow the tool to self-align itself with the slope of the roadway or shoulder and/or any irregularities in the pavement surface.

Subsection 642.03 Construction Requirements is hereby deleted and the following substituted therefore:

(a) Rumble Strips and Rumble Stripes in Asphalt Shoulders. The rumble strips shall be cut in the existing shoulders at the locations shown on the plans or as designated by the Engineer. Prior to commencement of the work, the Contractor shall demonstrate to the Engineer the ability to achieve the desired results without damaging the existing pavement. The Contractor shall remove existing raised pavement markers as the work progresses.

At the end of each working day, all equipment shall be removed from the roadway or parked no closer than 30' (15 m) from the nearest traveled lane. The pavement shall be thoroughly cleaned by sweeping or flushing. All excess material shall be disposed of in a manner approved by the Engineer.

The pavement markings shall be placed in accordance with Section 604.03(f) of the Standard Specifications. If interim or construction pavement markings are needed, edge lines will be required.

ARKANSAS DEPARTMENT OF TRANSPORTATION

SPECIAL PROVISION

JOB NO. A80035

RUMBLE STRIPS

- (b) Rumble Strips and Rumble Stripes in Portland Cement Concrete Shoulders.** The contractor shall have the option of cutting the rumble strips according to the above requirements or forming the mumble strips in the fresh concrete according to the requirements of Section 506.

The pavement markings shall be placed in accordance with Section 604.03(f) of the Standard Specifications. If interim or construction pavement markings are needed, edge lines will be required.

- (c) Centerline Rumble Stripes in Asphalt Roadways.** The rumble stripes shall be cut on the centerline of existing asphalt roadways at the locations shown on the plans or as designated by the Engineer. Prior to commencement of the work, the Contractor shall demonstrate to the Engineer the ability to achieve the desired results without damaging the existing pavement. The Contractor shall remove existing raised pavement markers as the work progresses.

At the end of each working day, all equipment shall be removed from the roadway or parked no closer than 30' (15 m) from the nearest traveled lane. The pavement shall be thoroughly cleaned by sweeping or flushing. All excess material shall be disposed of in a manner approved by the Engineer.

The pavement markings shall be placed in accordance with Section 604.03(f) of the Standard Specifications. If interim or construction pavement markings are needed, edge lines will be required.

Subsection 642.04 Method of Measurement is hereby deleted and the following substituted therefore:

Rumble strips in asphalt or Portland cement concrete shoulders will be measured by the linear foot (meter) longitudinally along the shoulder on which the rumble strips are constructed. No measurement or payment will be made for gaps, driveways, turnouts, or other public road intersections where the rumble strips have not been constructed.

Centerline rumble stripes will be measured by the linear foot (meter) longitudinally along the centerline of the roadway on which the rumble stripes are constructed. No measurement or payment will be made for turnouts or other public road intersections where rumble stripes have not been constructed.

Subsection 642.05 Basis of Payment is hereby deleted and the following substituted therefore:

Work completed and accepted and measured as provided above will be paid for at the contract unit price bid per linear foot (meter) for Rumble Strips in Asphalt Shoulders, Rumble Strips in Portland Cement Concrete Shoulders, Rumble Stripes in Asphalt Shoulders, or

ARKANSAS DEPARTMENT OF TRANSPORTATION

SPECIAL PROVISION

JOB NO. A80035

RUMBLE STRIPS

Rumble Stripes in Portland Cement Concrete Shoulders, which price shall be full compensation for constructing the rumble strips; for cleaning the pavement; for disposing of excess material; and for all labor, equipment, tools, and incidentals necessary to complete the work. Permanent pavement markings are not included in the price bid for rumble strips and shall be installed and paid for per the Standard Specifications.

Work completed and accepted and measured as provided above will be paid for at the contract unit price bid per linear foot (meter) for Centerline Rumble Stripes in Asphalt Roadways, which price shall be full compensation for removing the existing raised pavement markers; for constructing the rumble stripes; for cleaning the pavement; for disposing of excess material; and for all labor, equipment, tools, and incidentals necessary to complete the work. Permanent pavement markings are not included in the price bid for rumble stripes and shall be installed and paid for per the Standard Specifications.

The following items are added to the list of pay items:

Pay Item	Pay Unit
Centerline Rumble Stripes in Asphalt Roadways	Linear Foot (Meter)
Rumble Stripes in Asphalt Shoulders	Linear Foot (Meter)
Rumble Stripes in Portland Cement Concrete Shoulders	Linear Foot (Meter)

ARKANSAS DEPARTMENT OF TRANSPORTATION
SPECIAL PROVISION
LIQUIDATED DAMAGES

As specified in the Contract, liquidated damages for this project will be as shown in the following table:

WORKING DAY PROJECTS

ORIGINAL CONTRACT AMOUNT		
FROM MORE THAN	TO AND INCLUDING	RATE
\$ 0	\$ 100,000	\$ 140
100,000	500,000	400
500,000	1,000,000	660
1,000,000	2,000,000	800
2,000,000	5,000,000	1,380
5,000,000	10,000,000	1,800
10,000,000	15,000,000	2,620
15,000,000	20,000,000	2,720
20,000,000	30,000,000	2,940
30,000,000	-----	3,500

FIXED DATE PROJECTS

ORIGINAL CONTRACT AMOUNT		
FROM MORE THAN	TO AND INCLUDING	RATE
\$ 0	\$ 100,000	\$ 60
100,000	500,000	80
500,000	1,000,000	220
1,000,000	2,000,000	300
2,000,000	5,000,000	420
5,000,000	10,000,000	1,000
10,000,000	15,000,000	1,200
15,000,000	20,000,000	1,300
20,000,000	30,000,000	1,400
30,000,000	-----	1,520

ARKANSAS DEPARTMENT OF TRANSPORTATION

SUPPLEMENTAL SPECIFICATION

CONTRACTOR'S LICENSE

Section 102 of the Standard Specifications for Highway Construction, Edition of 2014, is hereby amended as follows:

The third paragraph of **Subsection 102.01, Prequalification of Bidders**, is hereby deleted and the following substituted thereof:

The attention of prospective bidders is directed to Ark. Code Ann. §17-25-101 et seq., Act 150 of the 1965 Acts of Arkansas, being an "Act Regulating the Practice of Contracting in the State of Arkansas", and any subsequent amendments made thereto. When the work offered is financed in whole with State funds and is estimated to cost \$50,000 or more, the prospective bidder must show evidence of its license and evidence of registration or license of its subcontractors with the Contractors Licensing Board for the State of Arkansas before being furnished with a proposal form.

The third paragraph of **Subsection 108.01, Subletting of Contract**, is hereby deleted and the following substituted thereof:

It shall be the responsibility of the Contractor to determine that all parties performing work amounting to \$50,000 or more are currently licensed or registered by the Contractors Licensing Board for the State of Arkansas.

ARKANSAS DEPARTMENT OF TRANSPORTATION
SUPPLEMENTAL SPECIFICATION
DEPARTMENT NAME CHANGE

All references to the Arkansas State Highway and Transportation Department contained within the Standard Specifications for Highway Construction (Edition of 2014), the Qualified Products List, the Manual of Field Sampling and Testing Procedures, plan sheets, Supplemental Specifications, and all Special Provisions contained in this proposal are hereby deleted and replaced with the title of Arkansas Department of Transportation.

All references to AHTD contained within the Standard Specifications for Highway Construction (Edition of 2014), the Qualified Products List, the Manual of Field Sampling and Testing Procedures, plan sheets, Supplemental Specifications, and all Special Provisions contained in this proposal are hereby deleted and replaced with the abbreviation ARDOT.

All references to the Arkansas State Highway Commission contained within the Standard Specifications for Highway Construction (Edition of 2014), the Qualified Products List, the Manual of Field Sampling and Testing Procedures, the Standard Drawings, plan sheets, Supplemental Specifications, and all Special Provisions contained in this proposal remain in effect.

ARKANSAS DEPARTMENT OF TRANSPORTATION
SUPPLEMENTAL SPECIFICATION
ISSUANCE OF PROPOSALS

Section 102 of the Standard Specifications for Highway Construction, Edition of 2014, is hereby amended as follows:

Subsection 102.04(j) is hereby deleted and the following is substituted therefore:

(j) If the prospective bidder is the Contractor on a current Contract with the Commission on which Liquidated Damages are being assessed, and there are no pending time extensions warranted to remove the project from Liquidated Damages.

Subsection 102.04(k) is hereby deleted and the following is substituted therefore:

(k) If the prospective bidder has a current Contract in default.

ARKANSAS DEPARTMENT OF TRANSPORTATION

SUPPLEMENTAL SPECIFICATION

CONTACT INFORMATION FOR MOTORIST DAMAGE CLAIMS

Section 103, AWARD AND EXECUTION OF CONTRACT, of the Standard Specifications for Highway Construction, Edition of 2014, is hereby amended as follows:

The following is added as the fourth paragraph of **Subsection 103.05(b), Liability Insurance**:

Prior to beginning construction, the Contractor shall provide the Engineer with the name, phone number and e-mail address for the individual within their organization responsible for submission of claims for damages to motorists' vehicles inside the work zones. This information shall be updated annually or whenever this responsibility changes within the Contractor's organization. The information will be made available to the public on the Department's webpage.

ARKANSAS DEPARTMENT OF TRANSPORTATION
SUPPLEMENTAL SPECIFICATION
MAINTENANCE DURING CONSTRUCTION

Division 100 of the Standard Specifications for Highway Construction, Edition of 2014, is hereby amended as follows:

Subsection 105.15 is hereby modified as follows:

The first paragraph of **Subsection 105.15** is hereby deleted and the following substituted therefor:

105.15 Maintenance During Construction. The Contractor shall maintain the work during construction and until the project is accepted. For contracts containing a Flexible Beginning of Work special provision, the responsibility for maintenance by the Contractor will begin at the earlier date of the following:

- when the Contractor begins work, or
- on the date of the beginning of time charges in accordance with the Work Order if the Contractor has not commenced work.

This maintenance shall constitute continuous and effective work prosecuted day by day, with adequate equipment and forces, to the end that the roadway or structures are kept in satisfactory condition at all times.

ARKANSAS DEPARTMENT OF TRANSPORTATION
SUPPLEMENTAL SPECIFICATION
RESTRAINING CONDITIONS

Section 107 of the Standard Specifications for Highway Construction, Edition of 2014, is hereby amended as follows:

The following is hereby added after the first bullet of the first paragraph of **Subsection 107.10 Restraining Conditions (a), General**:

- Human remains, burials, and/or associated burial artifacts

The following is hereby added after the second paragraph of **Subsection 107.10 (b), Restraining Conditions Within the Right-of-Way**:

When restraining conditions under (1) and (2) below are encountered, the following provisions should be executed.

(1) If archeological sites and/or historically significant cultural resources are unexpectedly impacted or subsequently discovered during construction, the Contractor shall stop work with no ground-disturbing activities occurring within a two hundred (200)-foot radius of the location of the discovery. The Engineer shall be notified immediately, who will then notify the Environmental Division. A Department staff archeologist will inspect the discovery and determine if the established buffer radius is appropriate. The radius may be decreased or increased based on the nature of the discovery at the discretion of the archeologist. Work in the buffer radius shall not resume until the Environmental Division has provided written notification to the Engineer that construction activities can proceed.

(2) If human remains, burials, and/or associated burial artifacts are encountered during construction, the Contractor shall stop work with no ground-disturbing activities occurring within a two hundred (200)-foot radius of the location of the discovery and the location secured and protected by flagging or fencing. The human remains shall be covered with a canvas tarp and shall not be removed or collected. The Engineer shall be notified immediately, who then will notify the Environmental Division. A Department staff archeologist will inspect the remains and determine if the established buffer is appropriate. The radius may be decreased or increased based on the nature of the discovery at the discretion of the archeologist. The local law enforcement and Chief Medical Examiner will be notified by the Environmental Division. Work in the buffer radius shall not resume until the Environmental Division has provided written notification to the Engineer that construction activities can proceed.

ARKANSAS DEPARTMENT OF TRANSPORTATION
SUPPLEMENTAL SPECIFICATION
RESTRAINING CONDITIONS

The following is hereby added after the third sentence of the first paragraph of **Subsection 107.10 (c), Restraining Conditions Outside the Right-of-Way, (2) Non-commercially Operated Site:**

The Contractor shall limit the amount of acres submitted for an off-site location to no more than 10 acres, except for commercial areas, previously approved locations, or where previous ground disturbance exists. If a Contractor requires more than 10 acres for a proposed off-site location, the Contractor may, at no cost to the Department, acquire approval for use of the site from the State Historic Preservation Officer and a qualified archeological consultant.

ARKANSAS DEPARTMENT OF TRANSPORTATION
SUPPLEMENTAL SPECIFICATION
WORK ALLOWED PRIOR TO ISSUANCE OF WORK ORDER

Section 108 of the Standard Specifications for Highway Construction, Edition of 2014, is hereby amended as follows:

Subsection 108.02(b)(2) is hereby deleted and the following is substituted therefore:

(2) The delivery to the Department for execution of the Contract and bonds properly executed on behalf of the Contractor and surety and the minimum 72 hours advance notice as required above shall constitute the Contractor's authority to begin the following items of work:

- Mobilization;
- Preparation of shop drawings and other required submissions;
- Ordering, fabrication, assembly, and/or stockpiling of materials;
- Driving Test Piling; and
- Contract surveying, when Roadway and/or Bridge Construction Control is included in the Contract.
- Erection of advance warning signs.
- Installation of netting on structures to prevent nesting of migratory birds in accordance with applicable Special Provisions (if included in the Contract).
- Set up, installation, and testing of Automated Work Zone Information Systems (if included in the Contract).
- Off-site area approval process per Section 107.10(c).

Such advance work shall be subject to the Contractor's assumption of the risk of cancellation of the award and the following:

- The Contractor shall, on commencing such operations, take all precautions required for public safety and shall observe all the provisions in the Contract;
- In the event of cancellation of the award, the Contractor shall at Contractor expense do such work as necessary to leave the site in a neat condition to the satisfaction of the Engineer;
- In the event of cancellation of the award, all work performed shall be deemed to be at the Contractor's expense; and
- All work done under this subsection in accordance with the Contract before its execution by the Commission will, when the Contract is executed, be considered authorized work and will be paid for as provided in the Contract.

Unless otherwise notified in writing, no time will be assessed for work performed prior to the effective date of a Work Order.

No payments will be made prior to the date established by the Engineer under Subsection 109.07, which date will be after the effective date of a Work Order.

The Contractor shall not be entitled to any additional compensation or an extension of time for any delay, hindrance, or interference caused by or attributable to commencement of work before the effective date of a Work Order.

ARKANSAS DEPARTMENT OF TRANSPORTATION

SUPPLEMENTAL SPECIFICATION

WORK ORDER FOR FIXED COMPLETION DATE CONTRACTS

Section 108, Prosecution and Progress, of the Standard Specifications for Highway Construction, Edition of 2014, is hereby amended as follows:

Subsection 108.02(b)(4) a. is hereby deleted, and the following is substituted therefor:

a. Fixed Completion Date Contract. Unless the Contractor is otherwise advised in writing, the Work Order for a fixed completion date contract shall become effective on the second business day following the execution of the Contract by the Department. (Example: If the contract is executed on Wednesday, March 1, the Work Order will be effective on Friday, March 3.) Should the effective date fall on Saturday, Sunday, legal holiday designated in Subsection 101.01(c), Monday following a holiday on Sunday, or Friday preceding a holiday on Saturday, the effective date shall still be on the second business day. The written Work Order from the Engineer will follow with the effective date being as specified.

ARKANSAS DEPARTMENT OF TRANSPORTATION
SUPPLEMENTAL SPECIFICATION
AGGREGATE BASE COURSE

Section 303 of the Standard Specifications for Highway Construction, Edition 2014, is hereby amended as follows:

The second paragraph of **Subsection 303.02, Materials** is hereby deleted and the following substituted therefor:

The Contractor shall have the option of using any higher numbered class Aggregate Base Course than that specified, provided that payment will be for the class specified. Acceptance criteria shall be for the class specified. Different classes of Aggregate Base Course shall not be mixed in the same location.

ARKANSAS DEPARTMENT OF TRANSPORTATION
SUPPLEMENTAL SPECIFICATION
QUALITY CONTROL AND ACCEPTANCE

Division 300 of the Standard Specifications for Highway Construction, Edition of 2014, is hereby amended as follows:

The first sentence of the third paragraph **Subsection 306.03 Acceptance Testing** is hereby deleted and the following substituted therefor:

If the material being furnished is crushed stone the Department will furnish the PL, LL, and PI for the material, further tests for PL, LL, and PI are waived.

ARKANSAS DEPARTMENT OF TRANSPORTATION
SUPPLEMENTAL SPECIFICATION
TACK COATS

Division 400 of the Standard Specifications for Highway Construction, Edition of 2014, is hereby amended as follows:

Section 401, Prime and Tack Coats and Emulsified Asphalt in Base Course, is hereby modified as follows:

The first sentence of **Subsection 401.03(a)** is hereby deleted and the following substituted therefore:

The surface to be treated with prime or tack coat shall be cleaned of dust, dirt, and loose or foreign material by sweeping with mechanical brooms immediately preceding the application of the prime or tack coat.

Third sentence of **Subsection 401.03(c)** is hereby deleted and the following is substituted therefore:

No dilution beyond that which is part of the emulsification process is permitted. The tack coat shall not be diluted, cut, or otherwise thinned after receipt from the manufacturer's facility.

The fifth sentence of **Subsection 401.03(c)** is hereby deleted and the following substituted therefore:

The rate of application shall be from 0.03 gallon to 0.10 gallon per square yard (0.1 L/sq m to 0.5 L/sq m) of residual asphalt as designated by the Engineer.

Section 410, Construction Requirements and Acceptance of Asphalt Concrete Plant Mix Courses, is hereby modified as follows:

The sixth paragraph of **Subsection 410.05** is hereby deleted and the following substituted therefore:

For foreign material, or when the time lapse between courses is more than 8 hours, the earlier course shall be cleaned and given a tack coat before placing the succeeding course. When directed, the tack coat shall be applied and paid for under Section 401. If directed by the Engineer, a tack coat shall be used even though the elapsed time has been less than 8 hours.

ARKANSAS DEPARTMENT OF TRANSPORTATION
SUPPLEMENTAL SPECIFICATION
DESIGN AND QUALITY CONTROL OF ASPHALT MIXTURES

Division 400 of the Standard Specifications for Highway Construction, Edition of 2014, is hereby amended as follows:

Section 404, QUALITY CONTROL OF ASPHALT MIXTURES, is hereby modified as follows:

The fifth sentence of the second paragraph of **Subsection 404.01, Design of Asphalt Mixtures, (a) General**, is hereby deleted and the following substituted therefor:

A mix design that has not been produced on an ARDOT project in the last two years is inactive. The Contractor may submit a passing field verification test for the inactive asphalt mix design to the Materials Division to be reactivated. Asphalt mix designs with an expiration date may remain in production if they are not inactive.

The third through fifth paragraphs of **Subsection 404.04, Quality Control of Asphalt Mixtures**, are hereby deleted and the following substituted therefor:

The accepted mix design shall be field verified by the Contractor at the start of mix production or after an interruption of more than 120 calendar days. Production of Department approved mix designs for placement on non-ARDOT projects may be used for mix verification. The Contractor shall be allowed two attempts to verify the mix design if being placed on an ARDOT project and three attempts to verify the mix design if being placed on a non-ARDOT project. The Contractor shall notify the Engineer sufficiently in advance for Department personnel to witness all testing of this production and shall provide copies of all test results to the Department.

Verification will begin with testing the plant produced mix using the aggregate proportions and asphalt binder content shown on the accepted mix design. After the first attempt of verification of the initial design, the Contractor may elect to adjust aggregate proportions to vary the accepted mix design gradations and bring the mix properties near the center of the compliance limits. If the mix is in subplot rejection, all future attempts will only be allowed on non-ARDOT projects.

The mix will be verified if the test values for air voids, asphalt binder content, and VMA are within the compliance limits shown in Table 410-1, and when the accepted mix design has been produced within the gradation tolerances according to Subsection 404.04.

The Contractor may request a one-time field mix design be accepted by the Engineer of Materials. The Contractor will be notified in writing if the field mix design is accepted. A field mix design allows the Contractor to use the adjusted aggregate proportions for future verification of the mix design. Cold feed adjustments will be allowed to both the initial mix design and field mix design if they do not exceed more than 10% for any single cold feed or 20% overall from the initial mix design. No individual cold feed will be allowed to be eliminated by such changes. Gradation tolerances will be based off the initial job mix formula. All cold feed adjustments exceeding the limits outlined above will require a new mix design.

Once verified, the asphalt binder content shall be adjusted at the plant to obtain the optimum asphalt binder content shown on the mix design during production based on the lot average. At no time shall the asphalt binder content be adjusted in a manner to produce an asphalt binder content lower

ARKANSAS DEPARTMENT OF TRANSPORTATION
SUPPLEMENTAL SPECIFICATION
DESIGN AND QUALITY CONTROL OF ASPHALT MIXTURES

than the design value. Adjustments to the asphalt binder content are not allowed for control of any volumetric property. All changes to be made to the asphalt binder content must first be reported to the Engineer. If adjustments do not give the intended result, production shall be stopped, and the asphalt plant and equipment shall be recalibrated and adjusted so the asphalt binder content can be successfully obtained.

The test method ARDOT 461, (NOTE 3), and (NOTE 4) in the table of the tenth paragraph of **Subsection 404.04, Quality Control of Asphalt Mixtures**, are hereby deleted.

The thirteenth and fourteenth paragraphs of **Subsection 404.04, Quality Control of Asphalt Mixtures, NOTE 3 and NOTE 4** are hereby deleted.

The eighteenth paragraph of **Subsection 404.04, Quality Control of Asphalt Mixtures**, is hereby deleted.

The fourth and fifth sentences in the nineteenth paragraph of **Subsection 404.04, Quality Control of Asphalt Mixtures**, are hereby deleted and the following substituted therefor:

Individual aggregate cold feeds should be adjusted to bring the mix design properties near the center of compliance limits. If excessive changes are required, production will be suspended, and a new mix design shall be developed according to the applicable specifications. Excessive changes are cold feed adjustments that exceed more than 10% for any single cold feed change or 20% overall from the initial mix design. No individual cold feed will be allowed to be eliminated by such changes. All cold feed adjustments exceeding the limits outlined above will require a new mix design.

Section 410, CONSTRUCTION REQUIREMENTS AND ACCEPTANCE OF ASPHALT CONCRETE PLANT MIX COURSES, is hereby modified as follows:

The first through third sentences in the first paragraph of **Subsection 410.09(a), General**, are hereby deleted and the following is substituted therefor:

The accepted mix design shall be verified by the Contractor at the start of mix production for that design or after an interruption of more than 120 calendar days. A maximum of 200 tons (200 metric tons) of materials may be placed on the roadway during the verification process. If the mix produced does not verify the mix design, the material placed on the roadway shall be declared a partial lot. If all verification attempts have been exhausted, a new mix design shall be required.

Section 411, ASPHALT CONCRETE COLD PLANT MIX, is hereby modified as follows:

The third sentence of **Subsection 411.05 (b), Acceptance**, is hereby amended and the following is substituted therefor:

The accepted mix design shall be field verified by the Contractor at the start of mix production or after an interruption of more than 120 calendar days.

ARKANSAS DEPARTMENT OF TRANSPORTATION
SUPPLEMENTAL SPECIFICATION
PERCENT AIR VOIDS FOR ACHM MIX DESIGNS

Division 400 of the Standard Specifications for Highway Construction, Edition of 2014, is hereby amended as follows:

The fourth sentence of Paragraph 1 of **Subsection 404.01(b), Design Requirements**, is hereby deleted and the following substituted therefor:

The optimum asphalt content is the asphalt binder content at 4% Air Voids (AV).

The first bullet of Paragraph 1 is hereby deleted and the following substituted therefor:

- PG 64-22 and PG 70-22 mixes will be designed using 4% air voids;

The second sentence of Paragraph 2 of **Subsection 404.04, Quality Control of Asphalt Mixtures**, is hereby deleted and the following substituted therefor:

Adjustments to the accepted mix design to conform to actual production values without re-design of the mixture shall be based on production of the mixture at a target value of 4.0% Air Voids (AV) in specimens and an asphalt binder content not less than that specified in the accepted mix design.

Table 405-1 of **Subsection 405.03 Materials** is hereby deleted and the following substituted therefor:

Table 405-1		
Design Requirements for Asphalt Concrete Hot Mix Base Course		
(1-1/2" [37.5 mm])		
Control Points		
Sieve (mm)	Percent Passing (%)	
2" (50.0)	100	
1½" (37.5)	90 - 100	
1" (25.0)	90 max.	
No. 4 (4.75)	-	
No. 8 (2.36)	15 - 41	
No. 16 (1.18)	-	
No. 30 (0.60)	-	
No. 50 (0.30)	-	
No. 200 (0.075)	0 - 6	
Asphalt Binder Content	Design Value	
% Air Voids	4.0	
% VMA	11.5 – 13.0	
Minimum Water Sensitivity Ratio	80.0	
% Anti-strip	As Required	
Fines to Asphalt Ratio*	0.6 – 1.6	
Wheel Tracking Test	<u>Design Gyration</u>	<u>Maximum Rut</u>
(8000 cycles, 100 psi, 64°C)	75 & 115	0.315 in. (8.000 mm)
	160	0.197 in. (5.000 mm)
	205	0.197 in. (5.000 mm)

*Fines to asphalt ratio shall be defined as the percent materials passing the No. 200 (0.075 mm) sieve (expressed as a percent of total aggregate weight) divided by the effective asphalt binder content.

ARKANSAS DEPARTMENT OF TRANSPORTATION
SUPPLEMENTAL SPECIFICATION
PERCENT AIR VOIDS FOR ACHM MIX DESIGNS

Table 406-1 of **Subsection 406.04, Construction Requirements and Acceptance**, is hereby deleted and the following substituted therefor:

Table 406-1		
Design Requirements for Asphalt Concrete Hot Mix Binder Course (1" [25 mm])		
Control Points		
Sieve (mm)	Percent Passing (%)	
1½" (37.5)	100	
1" (25.0)	90 - 100	
¾" (19.0)	90 max.	
No. 4 (4.75)	-	
No. 8 (2.36)	19 - 45	
No. 16 (1.18)	-	
No. 30 (0.60)	-	
No. 50 (0.30)	-	
No. 200 (0.075)	1 - 7	
Asphalt Binder Content	Design Value	
% Air Voids	4.0	
% VMA	12.5 – 14.0	
Minimum Water Sensitivity Ratio	80	
% Anti-strip	As Required	
Fines to Asphalt Ratio*	0.6 – 1.6	
Wheel Tracking Test (8000 cycles, 100 psi, 64°C)	<u>Design Gyration</u>	<u>Maximum Rut</u>
	75 & 115	0.315 in. (8.000 mm)
	160	0.197 in. (5.000 mm)
	205	0.197 in. (5.000 mm)

*Fines to asphalt ratio shall be defined as the percent materials passing the No. 200 (0.075 mm) sieve (expressed as a percent of total aggregate weight) divided by the effective asphalt binder content.

ARKANSAS DEPARTMENT OF TRANSPORTATION
SUPPLEMENTAL SPECIFICATION
PERCENT AIR VOIDS FOR ACHM MIX DESIGNS

Table 407-1 and Table 407-2 of **Subsection 407.04, Construction Requirements and Acceptance**, are hereby deleted and the following substituted therefor:

Table 407-1		
Design Requirements for Asphalt Concrete Hot Mix Surface Course (1/2" [12.5 mm])		
Control Points		
Sieve (mm)	Percent Passing (%)	
3/4" (19.0)	100	
1/2" (12.5)	90 - 100	
3/8" (9.5)	90 max.	
No. 8 (2.36)	28 - 58	
No. 16 (1.18)	-	
No. 30 (0.60)	-	
No. 50 (0.30)	-	
No. 200 (0.075)	2 - 10	
Asphalt Binder Content	Design Value	
% Air Voids	4.0	
% VMA	14.0 – 16.0	
Minimum Water Sensitivity Ratio	80.0	
% Anti-strip	As Required	
Fines to Asphalt Ratio*	0.6 – 1.6	
Wheel Tracking Test (8000 cycles, 100 psi, 64°C)	<u>Design Gyration</u>	<u>Maximum Rut</u>
	75 & 115	0.315 in. (8.000 mm)
	160	0.197 in. (5.000 mm)
	205	0.197 in. (5.000 mm)

*Fines to asphalt ratio shall be defined as the percent materials passing the No. 200 (0.075 mm) sieve (expressed as a percent of total aggregate weight) divided by the effective asphalt binder content.

ARKANSAS DEPARTMENT OF TRANSPORTATION
SUPPLEMENTAL SPECIFICATION
PERCENT AIR VOIDS FOR ACHM MIX DESIGNS

Table 407-2

Design Requirements for Asphalt Concrete Hot Mix Surface Course (3/8" [9.5 mm])

	Control Points	
Sieve (mm)	Percent Passing (%)	
1/2" (12.5)	100	
3/8" (9.5)	90 - 100	
No. 4 (4.75)	90 max.	
No. 8 (2.36)	32 - 67	
No. 16 (1.18)	-	
No. 30 (0.60)	-	
No. 50 (0.30)	-	
No. 200 (0.075)	2 - 10	
Asphalt Binder Content	Design Value	
% Air Voids	4.0	
% VMA	15.0 – 17.0	
Minimum Water Sensitivity Ratio	80.0	
% Anti-strip	As Required	
Fines to Asphalt Ratio*	0.6 – 1.6	
Wheel Tracking Test	<u>Design Gyration</u>	<u>Maximum Rut</u>
(8000 cycles, 100 psi, 64°C)	75 & 115	0.315 in. (8.000 mm.)
	160	0.197 in. (5.000 mm)
	205	0.197 in. (5.000 mm)

*Fines to asphalt ratio shall be defined as the percent materials passing the No. 200 (0.075 mm) sieve (expressed as a percent of total aggregate weight) divided by the effective asphalt binder content.

ARKANSAS DEPARTMENT OF TRANSPORTATION

SUPPLEMENTAL SPECIFICATION

LIQUID ANTI-STRIP ADDITIVE

Division 400 of the Standard Specifications for Highway Construction, Edition of 2014, is hereby amended as follows:

Section 404, DESIGN AND QUALITY CONTROL OF ASPHALT MIXTURES, is hereby modified as follows:

The following is added as the last bullet following the first paragraph of **Subsection 404.01(b), Design Requirements**:

- All ACHM mixes must contain a liquid, anti-strip additive.

Section 409, MATERIALS AND EQUIPMENT FOR ASPHALT CONCRETE PLANT MIX COURSES, is hereby modified as follows:

The second paragraph of **Subsection 409.02 Asphalt Binder** is hereby deleted and the following substituted therefor:

The asphalt binder for all Asphalt Concrete Hot Mixes shall contain a heat-stable, liquid anti-strip additive. The additive shall be furnished from the Qualified Products List. The additive shall not harm the completed bituminous concrete mixture and must be compatible with the aggregate and asphalt binder supplied for the project. The anti-strip additive shall be added either by an in-line blending process just before introduction of the asphalt binder to the mixer or by blending with the asphalt binder at the asphalt binder terminal. If blended at the terminal, the bill of lading accompanying the load being delivered to the hot mix asphalt plant shall include the anti-strip manufacturer's name, product name, and quantity of all anti-strip additive included in the load.

The liquid anti-strip additive shall be added at rates as indicated below:

- For ACHM mixes where the use of an anti-strip additive is required as determined by the laboratory analysis and mix design procedures, the anti-strip additive shall be added at the rate of 0.5% to 0.75% (0.05% to 0.10% for organosilane based materials) by weight of asphalt binder as determined by the laboratory analysis and laboratory mix design procedures.
- For all other mixes, the manufacturer's recommended dosage of the additive shall be used, but the rate of liquid anti-strip additive shall not be less than 0.25% (0.05% for organosilane based materials) by weight of the asphalt binder.

ARKANSAS DEPARTMENT OF TRANSPORTATION

SUPPLEMENTAL SPECIFICATION

TRACKLESS TACK

Sections 401 and 403 of the Standard Specifications for Highway Construction, Edition of 2014, is hereby amended as follows:

The following is hereby added after the second sentence of **Subsection 401.02 Materials**:

Trackless Tack meeting the requirements of this supplemental specification may be used as Tack Coat at no additional cost to the Department.

The following is hereby added after the fifth sentence of **Subsection 401.03(c), Application of Tack Coat**:

When Trackless Tack is used, the Contractor shall follow the manufacturer's recommendations for storage, application temperature, and application rate.

The following is hereby added as the second paragraph of **Subsection 401.06, Basis of Payment**:

If the Contractor elects to use Trackless Tack in lieu of Tack Coat, the application and payment for the material used will be measured and paid for at the contract unit price bid for Tack Coat per gallon (liter).

The following is hereby added after the second sentence of the first paragraph **Subsection 403.03, Asphalt Materials**:

The manufacturer shall submit certified test results for Trackless Tack to the Engineer.

ARKANSAS DEPARTMENT OF TRANSPORTATION

SUPPLEMENTAL SPECIFICATION

TRACKLESS TACK

The following is hereby added as **Subsection 403.03 (g), Trackless Tack:**

Trackless tack shall be an anionic or cationic asphalt emulsion conforming to the requirements below:

	Test Method	Min	Max
Viscosity, Saybolt Furol at 25°C SFS	AASHTO T59	20	150
Storage stability test, 24-h, %	AASHTO T59		1
Sieve test, %	AASHTO T59		0.3
Residue by distillation, %	AASHTO T59	50	
Tests on residue from distillation:			
Penetration, 25°C, 100 g, 5 s	AASHTO T59		20
*Solubility %	AASHTO T44	97.5	
*Ash Content	AASHTO T111		1
Softening Point °C	AASHTO T53	65	

*Ash Content or Solubility may be used for testing purposes of the residue from distillation.

ARKANSAS DEPARTMENT OF TRANSPORTATION**SUPPLEMENTAL SPECIFICATION****DESIGN OF ASPHALT MIXTURES**

Section 400 of the Standard Specifications for Highway Construction, Edition of 2014, is hereby amended as follows:

The following is added after the first sentence of paragraph 3 **Subsection 404.01 Design of Asphalt Mixtures. (b) Design Requirements:**

Any use of recycled engine oil bottoms (REOB) or other engine oil derivatives in the manufacture or modification of a binder are strictly prohibited. Ground Tire Rubber (GTR) may be added to asphalt binder with blending of GTR into asphalt occurring only at the asphalt terminal. GTR shall be Class 80-1 ground tire rubber as defined by ASTM D5603.

ARKANSAS DEPARTMENT OF TRANSPORTATION
SUPPLEMENTAL SPECIFICATION
ASPHALT LABORATORY FACILITY

Division 400 of the Standard Specifications for Highway Construction, Edition of 2014, is hereby amended as follows:

Subsection 409.03(h), Plant Inspection, is hereby deleted and the following substituted therefor:

(h) Plant Inspection. The Engineer shall have access to all parts of the plant.

The Contractor shall provide and maintain a laboratory facility for the exclusive use of the Engineer. This facility shall be located at the plant site. The dimensions and other requirements specified herein are minimums. The facility may be built by the Contractor for the specific purposes stated. Portable structures used as lab facilities must be anchored to the ground and have adequate reinforcement to the floor to provide stability for lab equipment. It is not intended, however, to preclude the use of commercially built trailers or prefabricated buildings that may deviate in minor dimension or detail from the requirements listed but may in some features exceed these requirements and in all major respects be entirely suitable for the purpose intended. The Contractor may furnish, in lieu of a separate building, a facility having sufficient space in a building, parts of which are used for other purposes, provided that the facility furnished meets all other requirements of this subsection; is physically separated from the remainder of the building; and has an outside entrance with unrestricted access allowed and reserved for the exclusive use of the Engineer. Adequate space shall be provided for parking of at least three Department vehicles in the vicinity of the facility. The Engineer will determine the suitability of any facility furnished.

General requirements for the laboratory facility are:

- Minimum working laboratory space of 380 square feet (35.3 sq m) for building widths between 8' to 12' (2.4 to 3.7 m) or 208 square feet (19.3 sq m) with a width of 12' (3.7 m) or greater.
- Minimum designated office space of 30 square feet (2.8 sq m) shall be included in addition to the laboratory square footage.
- A ceiling height of 8' (2.4 m) or greater.
- A desk or table approximately 24" x 36" (600 mm x 900 mm), with at least two drawers, each approximately 13" x 13" x 18" (330 mm x 330 mm x 450 mm) for storing records and at least three office style rolling chairs.
- At least one door with a substantial lock and all keys placed in the possession of the Engineer. The door must be a minimum of 36" (900 mm) wide. A second entry door at the end of trailers that are greater than 30' (9.1 m) in length will be required for safety reasons.
- Access to a well-maintained restroom, with a functioning sink, within reasonable proximity to the Department laboratory facility. Portable restrooms are not acceptable.
- Floored, weatherproof, and reasonably dustproof.

ARKANSAS DEPARTMENT OF TRANSPORTATION
SUPPLEMENTAL SPECIFICATION
ASPHALT LABORATORY FACILITY

- Level and stable with substantial/durable structure capable of supporting required laboratory equipment. Movement in the lab shall not affect testing operations such as scale readings, etc.
- At least two glazed screened windows capable of being opened and locked only from the inside.
- Basic utility services shall be provided year-round as long as the plant is listed on the QPL. If utility services to the Department lab are voluntarily suspended at any time, the plant may be removed from the QPL.
- Equip the lab with heating and air conditioning units that maintain the ambient air temperature between 65 °F and 80 °F (18 °C and 27°C). The lab must be climate-controlled year-round.
- A work counter approximately 30" to 36" (760 to 900 mm) high with a minimum depth of 30" (760 mm). The countertop shall be metal capped with a rolled back edge of 2" (50 mm) if adjacent to the wall or other comparable durable surface. Total length of the work counter shall be approximately 35' (10.7 m) with a minimum of 12' (3.7 m) of counter length 36" (900 mm) deep.
- A minimum of 54" (1370 mm) width between parallel work counters.
- Adequate electric lights suitable for the purposes intended. At least one power outlet per every four feet of counter. At least two power outlets shall provide 220 VAC.
- An exhaust outlet with at least 3" (76 mm) inside diameter no farther than 8' (2.4 m) from the ignition oven shall be included near one of the 220 VAC outlets. Provide a surface for the ignition oven that is level, sturdy, and fireproof with at least 6" (152 mm) of clearance between the furnace and other vertical surfaces. The exhaust fumes exiting the furnace exhaust port may reach 270 °C (518 °F).
- An exhaust fan shall be installed over the equipment clean up area. The exhaust fan shall be equipped with a rheostat control and capable of exhausting in one minute a volume of air equal to the volume of the entire laboratory. The exhaust fan shall be maintained operational.
- A sink, approximately 25" (635 mm) square with a minimum depth of 9" (230 mm) with an outside drain.
- A clean water supply providing a minimum of 50 gallons (200 liters) storage capacity (or connected to a public or private water system), discharging through a faucet above the sink. A thermostat controlled hot water supply shall be provided to the laboratory sink.
- Adequate shelves and/or cabinets for storage of testing equipment that do not impede the operation of testing equipment.
- A storage area for storing nuclear equipment, complete with a substantial lock and all keys to this area placed in the possession of the Engineer.
- At least one Type ABC fire extinguisher (10-pound size minimum) with up-to-date inspection tag per 300 square feet of building.

ARKANSAS DEPARTMENT OF TRANSPORTATION
SUPPLEMENTAL SPECIFICATION
ASPHALT LABORATORY FACILITY

- A local access touchtone telephone line (with access to toll free telephone numbers but otherwise blocked for outgoing long-distance calls), with a landline modular jack and touchtone telephone, shall be provided in the laboratory facility for use by Department personnel.
- Reliable Broadband Internet Service shall be provided.
The Broadband Internet Service shall be provided with an Internet Protocol (IP) address which is reachable on the global Internet (public) and which is permanently assigned (static). The Contractor is not required to provide this service if an IP address which is both static and public is not available.

If this service is not available at the beginning of a project but becomes available during the life of the project, the Contractor shall provide the service immediately from the date of availability.

The data transfer rate shall be 3 megabits per second (Mbps) download and 500 kilobits per second (kbps) upload, or higher, with latency not to exceed 150 milliseconds. If the Broadband Internet Service meets all of the requirements of this specification except for the data transfer rate and/or latency, then the best performing available connection shall be provided. The Broadband Internet Service shall be provided with equipment providing a minimum of one Ethernet port.

Prior to the selection of the Broadband Internet Service provider, the Contractor shall submit to the Resident Engineer, in writing, the proposed method for providing Broadband Internet Service. The Resident Engineer shall review this submittal and respond in writing regarding the acceptability of the proposed method.

Adequate maintenance of the laboratory facility shall be required for plant inclusion on the QPL and will be included as part of the annual ACHM plant inspection. Maintenance shall include, but is not limited to, HVAC and electrical systems, and plumbing. The Resident Engineer may determine a lab is in reasonable compliance with this specification if all required testing can be accomplished with reasonable ease by the Construction Materials Inspector.

The requirements of this Supplemental Specification shall be implemented in order to receive the next scheduled ACHM Plant Certification. If the requirements are not met and the Resident Engineer determines the laboratory is not within reasonable compliance an ACHM Plant Certification will not be provided until all requirements are fulfilled and/or the Resident Engineer is satisfied with the conditions of the facilities.

The field laboratory for asphalt mixing plants and the utility services provided will not be paid for directly but will be considered a part of the asphalt mixing plant.

ARKANSAS DEPARTMENT OF TRANSPORTATION

SUPPLEMENTAL SPECIFICATION

**CONSTRUCTION REQUIREMENTS AND ACCEPTANCE OF
ASPHALT CONCRETE PLANT MIX COURSES**

Section 410, Construction Requirements and Acceptance of Asphalt Concrete Plant Mix Courses, of the Standard Specifications for Highway Construction, Edition of 2014, is hereby modified as follows:

Subsection 410.10 Incentives is hereby deleted.

ARKANSAS DEPARTMENT OF TRANSPORTATION

SUPPLEMENTAL SPECIFICATION

DEVICES FOR MEASURING DENSITY FOR ROLLING PATTERNS

Section 410 of the Standard Specifications for Highway Construction, Edition of 2014, is hereby amended as follows:

The fourth sentence of the first paragraph of **Subsection 410.08, Rolling and Density Requirements and Joints**, is hereby deleted and the following substituted therefor:

The Engineer will observe the Contractor's use of an electromagnetic surface contact device that meets ASTM D7113/D7113M or the use of a nuclear density gauge to verify that the maximum densities possible are obtained.

ARKANSAS DEPARTMENT OF TRANSPORTATION

SUPPLEMENTAL SPECIFICATION

EVALUATION OF ACHM SUBLLOT REPLACEMENT MATERIAL

Section 410 of the Standard Specifications for Highway Construction, Edition of 2014, is hereby amended as follows:

The following shall be added to the second to the last paragraph of **Subsection 410.09 (a)**

General:

If the material used to replace unacceptable material is a different mix design from what was originally placed, the remaining material in the lot and the replacement material shall both be evaluated as separate partial lots.

ARKANSAS DEPARTMENT OF TRANSPORTATION
SUPPLEMENTAL SPECIFICATION
RECYCLED ASPHALT PAVEMENT

Division 400 of the Standard Specifications for Highway Construction, Edition of 2014, is hereby amended as follows:

The fourth paragraph of **Subsection 416.03, Materials and Composition**, is hereby deleted and the following substituted therefor:

To ensure the “production” stockpile is distinguishable to anyone involved in the production of asphalt at the plant and no “unprocessed” materials are introduced into the process of ACHM mix manufacturing, the following shall be required for the use of Recycled Asphalt Pavement (RAP):

- RAP stockpiles should have only binder covered aggregates and therefore, there shall be no virgin aggregate or deleterious materials present in any RAP stockpile. Uncoated aggregate from asphalt plant produced material shall not be considered virgin aggregate as it applies to RAP. Plant startup and shut down materials will be considered binder covered and are allowed.
- Unprocessed RAP and processed RAP stockpiles shall be separated by distance and each stockpile signed accordingly.
- Only processed RAP shall be introduced into asphalt mixes. Processed is defined as efforts to create a uniform stockpile of material and may include, but is not limited to, crushing and/or fractionating. Use of the scalper screen on the plant does not define processed RAP.
- Processed RAP stockpiles shall be of adequate size for multiple operational days of asphalt mix production at the plant’s maximum production rate. Processed RAP must be stockpiled before use in plant production. Processed RAP may not be taken from underneath the crusher and placed directly into the cold feed bins. If the crusher is feeding the processed stockpile, the loader must load the cold feed bins from the opposite end of the processed stockpile.

Quality control testing for asphalt binder content and gradation of RAP shall be the contractor’s responsibility and conducted as follows:

- Tested as part of the field verification process. Field verification test results may be transferred from another ARDOT job given they are from the same mix design and were completed within 120 days of the current job’s field verification process.
- Minimum of one set of tests per job for jobs that contain at least 1,000 tons of ACHM.
- One set of tests for every 10,000 tons of ACHM produced.
- The first tests on the job must be performed within the first 3 days of production on the job.

ARKANSAS DEPARTMENT OF TRANSPORTATION
SUPPLEMENTAL SPECIFICATION
RECYCLED ASPHALT PAVEMENT

The Contractor has the option of quality control testing while the processed stockpile is being built in lieu of testing during production. Quality control testing for asphalt binder content and gradation of RAP shall be the Contractor's responsibility and conducted as follows:

- Tested as part of the field verification process. Field verification test results may be transferred from another ARDOT job given they are from the same mix design and were completed within 120 days of the current job's field verification process.
- One set of tests for every 1,500 tons of RAP produced for each stockpile.
- The quantity of RAP being placed in the processed stockpile must be tracked.

The Contractor shall pick only one option of quality control method per processed RAP stockpile. The Engineer shall be given the opportunity to witness all testing. Test results shall be submitted to the Engineer by the next business day. The Contractor shall keep a logbook to track the consistency of the asphalt binder content and gradation.

If testing determines the properties of the RAP have deviated significantly from the mix design, as determined by the Engineer, changes to virgin binder content and/or aggregate proportions will be required before production of the ACHM continues. Once adjustments are made and the plant produced mix has the desired properties, the Contractor may request that a field mix design be accepted by the Engineer.

To create uniform, repeatable testing for RAP binder content, asphalt binder content of the RAP shall be determined using AASHTO T 308 with the specific requirements as follows:

- Sample shall be dried to a constant mass as per AASHTO T 329 using a drying temperature of $230\text{ }^{\circ}\text{F} \pm 9\text{ }^{\circ}\text{F}$.
- The ignition oven burn temperature used during the mix design process must be used for quality control. The burn temperature shall be reported on the mix design submittal.
- Asphalt Binder Content = % loss – Aggregate Correction Factor (ACF)
- An ACF for each processed RAP stockpile shall be submitted with the mix design if used. An ACF for the job mix formula shall be submitted on the mix design if used. If multiple ignition ovens are used, an ACF for each oven shall be submitted.
- Determination of the ACF may be based on regional historical data at the time of the change. This will ensure all parties involved are aware of the correction factor and therefore avoiding disagreements pertaining to manipulation/fluctuation in aggregate correction factors that could be used to adjust binder content data.

ARKANSAS DEPARTMENT OF TRANSPORTATION

SUPPLEMENTAL SPECIFICATION

INCIDENTAL CONSTRUCTION

Sections 609, 611, 617, and 618 of the Standard Specifications for Highway Construction, Edition of 2014, are hereby amended as follows:

Subsection 609.02(c), Materials for Drop Inlets and Junction Boxes, is hereby deleted and the following is substituted therefor:

- (c) Steel for welded steel grates and frames shall comply with ASTM A709, Grade 36 (250).

Subsection 611.02(a)(2), Materials for Pipe Underdrains, Outlet Protectors, and Covers, is hereby deleted and the following is substituted therefor:

- (2) **Corrugated Polyethylene Tubing.** The tubing shall be the heavy duty type and shall comply with AASHTO M 252. The tubing shall have a minimum pipe stiffness of 46 psi (3.23 kg/cm²) at 5% deflection and shall be capable of 60 percent vertical deflection in parallel plate loading without splitting or cracking when tested in accordance with ASTM D 2412.

The second sentence of **Subsection 617.02(a)(2), Materials for Steel Posts**, is hereby deleted and the following is substituted therefor:

- (2) **Steel Posts.** The steel shall comply with ASTM A709, Grade 36 (250).

Subsection 617.02(b)(3), Materials for Terminal Anchor Posts, is hereby deleted and the following is substituted therefor:

- (3) The steel anchor posts shall consist of structural shapes of the section shown on the plans, or as otherwise specified, and shall comply with ASTM A709, Grade 36 (250). The upper 15" (380 mm) of the anchor assembly shall be galvanized according to AASHTO M 111.

The third sentence of the third paragraph **Subsection 618.02(a), Posts for Guard Cable**, is hereby deleted and the following is substituted therefor:

- The steel shall comply with ASTM A709, Grade 36 (250).

Subsection 618.02(d), Materials for Bolts, Nuts, and Washers, is hereby deleted and the following is substituted therefor:

ARKANSAS DEPARTMENT OF TRANSPORTATION**SUPPLEMENTAL SPECIFICATION****INCIDENTAL CONSTRUCTION**

(d) Bolts, Nuts, and Washers. Bolts, nuts, and washers shall conform to the plans and shall be steel complying with ASTM A 307, ASTM F3125, Grade A325, Heavy Hex, Type 1, or ASTM A449 (Heavy Hex), galvanized according to AASHTO M 232. Threads on bolts and nuts shall conform to Unified Coarse Thread Series Class 2A, ANSI B 1.1 (Metric Coarse Thread Series, ANSI B 1.13M, 6g tolerance).

ARKANSAS DEPARTMENT OF TRANSPORTATION**SUPPLEMENTAL SPECIFICATION****LANE CLOSURE NOTIFICATION**

Division 600 of the Standard Specifications for Highway Construction, Edition of 2014, is hereby amended as follows:

Section 603, Maintenance of Traffic and Temporary Structures, is hereby modified as follows:

The first sentence of the third paragraph **Subsection 603.02 (d)** is hereby deleted and the following substituted therefor:

The Contractor shall provide the Engineer with a minimum of five full business days advance, written notification of any nonemergency lane closure or lane width restriction. The first full business day shall commence at midnight on the first business day following written notification to the Engineer. This advanced notification is required to allow adequate notice for the issuance of over width load permits by the Department.

ARKANSAS DEPARTMENT OF TRANSPORTATION
SUPPLEMENTAL SPECIFICATION
RETROREFLECTIVE SHEETING FOR
TRAFFIC CONTROL DEVICES IN CONSTRUCTION ZONES

Section 604 of the Standard Specifications for Highway Construction, Edition of 2014, is hereby amended as follows:

The following is inserted after the first paragraph of Subsection 604.02(b):

Retroreflective sheeting used on traffic drums shall meet the requirements of ASTM D4956 for Type III or IV with the additional requirements for Reboundable Sheeting. Retroreflective sheeting for delineators shall comply with section 728.

Retroreflective sheeting shall be applied to a properly treated substrate with mechanical equipment and in a manner specified by the sheeting manufacturer. Sign material (substrate) shall be of sufficient thickness and stability to maintain a substantial, effective sign for the duration of the project. One splice will be allowed in retroreflective sheeting on sign blanks. "Left", "Right", "Distances", and "Ahead" will be allowed on signs as inserts. All letters and numerals on inserts shall be of the same size and series as those on the sign face.

ARKANSAS DEPARTMENT OF TRANSPORTATION

SUPPLEMENTAL SPECIFICATION

TRAFFIC CONTROL DEVICES IN CONSTRUCTION ZONES (MASH)

Section 604 of the Standard Specifications for Highway Construction, Edition of 2014, is hereby amended as follows:

The first paragraph of **Subsection 604.02 Materials (a) General** is hereby deleted and the following substituted therefor:

All work zone traffic control devices used on the project, including sign supports, barricades, traffic drums equipped with flashing lights, crash cushions, and impact attenuators, manufactured after December 31, 2019, shall comply with the requirements of the Manual for Assessing Safety Hardware (MASH). Such devices manufactured on or before December 31, 2019, and successfully tested to the requirements of National Cooperative Highway Research Program (NCHRP) Report 350 or the 2009 edition of MASH, may continue to be used throughout their normal service lives. The Contractor shall furnish a certification of such compliance from the manufacturer or supplier of all work zone traffic control devices prior to using the devices on the project. The certification shall state the device meets the requirements of MASH, or in the case that the device was manufactured on or before December 31, 2019, the certification shall state the device meets the requirements of NCHRP 350 or MASH. The certification shall include a copy of the Federal Highway Administration's (FHWA) approval letter with all attachments for each device. Devices shall be fabricated and installed in accordance with the plans and with the crash testing documentation provided in the FHWA approval letter which is available at:

http://safety.fhwa.dot.gov/roadway_dept/policy_guide/road_hardware/.

ARKANSAS DEPARTMENT OF TRANSPORTATION
SUPPLEMENTAL SPECIFICATION
GUARDRAIL TERMINAL (TYPE 2)

Section 617 of the Standard Specifications for Highway Construction, Edition of 2014, is hereby amended as follows:

The third paragraph of subsection **617.01 Description** is hereby deleted and the following substituted therefor:

The item “Guardrail Terminal (Type 2)” shall consist of furnishing and installing an acceptable crashworthy end terminal for W-beam guardrail at the locations shown in the plans or as directed by the Engineer. The guardrail terminal shall be specifically designed as a W-beam guardrail terminal, and shall provide an anchor against which the full tensile strength of the rail can be developed for downstream hits while remaining crashworthy for end-on impacts. The guardrail terminal shall satisfy the Manual for Assessing Safety Hardware (MASH) Test Level 3 (TL-3). The guardrail terminal shall be of a configuration that will be compatible with the site geometry shown on the plans. Guardrail terminals that require additional grading or require anchoring outside the limits of the site shown on the plans will be acceptable; however, the cost of any additional site work shall be included in the price bid for the particular type of guardrail terminal used. Guardrail terminals shown on the plans shall be 50 feet (15 meters) in length. Any additional length of guardrail needed to fulfill the 50 feet (15 meters) requirement shall be included in the price bid for the particular type of guardrail terminal used.

The first paragraph of subsection **617.02(f), Guardrail Terminal (Type 2)**, is hereby deleted and the following substituted therefor:

The Contractor shall furnish a certification from the manufacturer or supplier that the guardrail terminal meets the requirements of MASH Test Level 3 (TL-3). All materials shall be new. Rail elements and posts shall meet the requirements above. All steel components shall be galvanized. All parts shall be clearly identified for proper assembly and replacement.

ARKANSAS DEPARTMENT OF TRANSPORTATION
SUPPLEMENTAL SPECIFICATION
GUARDRAIL DELINEATORS

Division 600 of the Standard Specifications for Highway Construction, Edition of 2014, is hereby amended as follows:

Section 617, GUARDRAIL is hereby modified as follows:

The following is hereby added as **Subsection 617.02(g) Delineators**.

Guardrail delineators shall be included on the Department's Qualified Product List (QPL).

The following is hereby added as **Subsection 617.03 (g) Delineators**.

Guardrail delineators shall be installed at 37.5' spacing maximum in tangent sections except that any individual run of guardrail shall have no less than three delineators installed. Spacing may be reduced in curves as directed by the Engineer.

Guardrail delineators shall have a minimum reflective area of 8.0 sq. in. per side, be made of galvanized metal with a 12-gauge minimum thickness, and be capable of being bolted to the guardrail web. The delineator shall have two (2) reflective surfaces and shall use reflective sheeting conforming to ASTM D4956 Types VIII or IX. Reflective sheeting used shall be listed on the Department's Qualified Products List (QPL) 723 Reflective Sheeting.

The following is hereby added as the last sentence of **Subsection 617.05 Basis of Payment. (a)**

Payment for the Guardrail Delineators will not be paid for separately, but full compensation therefor will be considered included in the contract unit price for Guardrail (Type ____).

ARKANSAS DEPARTMENT OF TRANSPORTATION
SUPPLEMENTAL SPECIFICATION
CEMENT

Section 802 of the Standard Specifications for Highway Construction, Edition of 2014, is hereby amended as follows:

The following is added as the last bullet of the second paragraph of **Subsection 802.02, Materials. (a) Cement.**

- Portland-Limestone Cement, AASHTO M240, Type 1L. Type 1L shall have a limestone constituent greater than 5 percent and less than or equal to 15 percent by mass of blended cement.

The second sentence of the fourth paragraph of **Subsection 802.02, Materials. (a) Cement** is revised as follows:

The total alkalis in the cementitious material (Portland cement, Portland – Limestone cement, fly ash or slag cement) shall not exceed 5 lb/cu yd (3 kg/cu m).

ARKANSAS DEPARTMENT OF TRANSPORTATION
CONSTRUCTION PLANS FOR STATE HIGHWAY



FILE NO.	DATE	BY	NO.	DATE	BY
6	ARL	A80035	I		II
YELL CO. LINE - PERRY (S)					

EXCEPTIONS TO JOB A80035
(BRIDGES)

① LOG MILE 2.510 BR. END
105.60' TOTAL LENGTH
34' - 11" CLEAR ROADWAY
BR. NO. 06692
LOG MILE 2.530 BR. END

② LOG MILE 11.937 BR. END
163.68' TOTAL LENGTH
34' - 7" CLEAR ROADWAY
BR. NO. 06702
LOG MILE 11.968 BR. END

YELL CO. LINE - PERRY (S)

PERRY COUNTY
ROUTE 10 SECTION 5
JOB A80035
FED. AID PROJ. STPR-0053(40)



ARK. HWY. DIST. NO. 8

NOT TO SCALE

LOG MILE 18.278
END JOB A80035

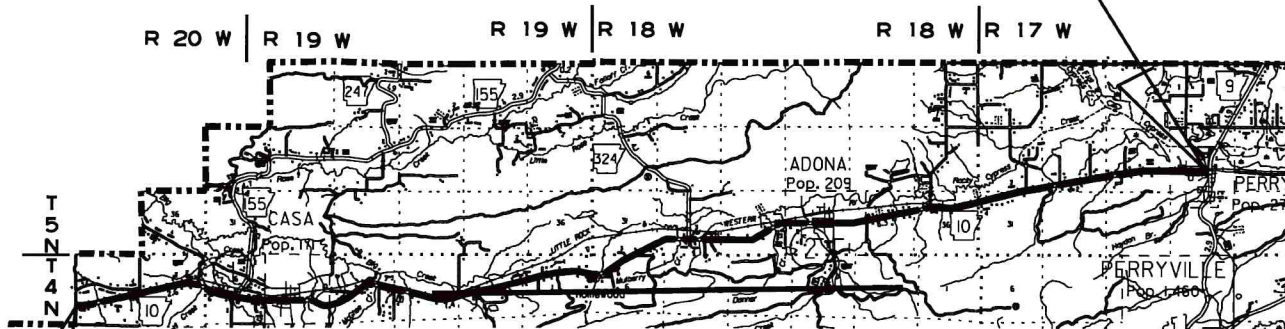

LOG MILE 0.000
BEGIN JOB A80035



APPROVED

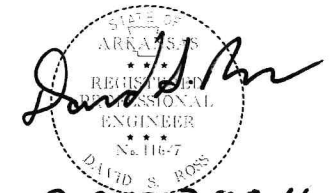

3-25-2024
DISTRICT ENGINEER

				LENGTH OF PROJECT CALCULATED ALONG C.L.			
	BEGIN PROJECT	MID-POINT OF PROJECT	END PROJECT				
LATITUDE	N 35°01' 22"	N 35°01' 55"	N 35°02' 55"	GROSS LENGTH OF PROJECT	96507.84	FEET OR	18.278 MILES
LONGITUDE	W 93°06' 22"	W 92°57' 02"	W 92°47' 36"	NET ROADWAY	96238.56		18.227 MILES
				NET BRIDGES	0.00		0.000 MILES
				NET PROJECT	96238.56		18.227 MILES

INDEX OF SHEETS

SHEET NO.	TITLE
1	TITLE SHEET
2 - 3	INDEX OF SHEETS, STANDARD DRAWINGS, AND GOVERNING SPECIFICATIONS
4	GENERAL NOTES
5	TYPICAL SECTIONS OF IMPROVEMENT
6 - 7	SPECIAL DETAILS
8 - 10	QUANTITIES
11	SUMMARY OF QUANTITIES AND REVISIONS

ROADWAY STANDARD DRAWINGS

DRWG.NO.	TITLE	DATE
DR-3	DETAILS OF DRIVEWAYS & STREET TURNOUTS (PAVEMENT PRESERVATION) DETAILS	04-13-23
GR-6	GUARDRAIL DETAILS	05-19-22
GR-7	GUARDRAIL DETAILS	11-07-19
GR-8	GUARDRAIL DETAILS	11-07-19
GR-9	GUARDRAIL DETAILS	11-07-19
GR-10	GUARDRAIL DETAILS	11-07-19
GR-11	GUARDRAIL DETAILS	11-07-19
GR-12	GUARDRAIL DETAILS	05-14-20
PM-1	PAVEMENT MARKING DETAILS	02-27-20
TC-1	STANDARD TRAFFIC CONTROLS FOR HIGHWAY CONSTRUCTION	11-07-19
TC-2	STANDARD TRAFFIC CONTROLS FOR HIGHWAY CONSTRUCTION	05-20-21
TC-3	STANDARD TRAFFIC CONTROLS FOR HIGHWAY CONSTRUCTION	08-12-21

GOVERNING SPECIFICATIONS

ARKANSAS STATE HIGHWAY COMMISSION STANDARD SPECIFICATIONS FOR HIGHWAY
CONSTRUCTION, EDITION OF 2014, AND THE FOLLOWING SPECIAL PROVISIONS
AND SUPPLEMENTAL SPECIFICATIONS:

NUMBER	TITLE
ERRATA	ERRATA FOR THE BOOK OF STANDARD SPECIFICATIONS
FHWA-1273	REQUIRED CONTRACT PROVISIONS FEDERAL-AID CONSTRUCTION CONTRACTS
FHWA-1273	SUPPLEMENT - EQUAL EMPLOYMENT OPPORTUNITY - NOTICE TO CONTRACTORS
FHWA-1273	SUPPLEMENT - SPECIFIC EQUAL EMPLOYMENT OPPORTUNITY RESPONSIBILITIES (23 U.S.C. 140)
FHWA-1273	SUPPLEMENT - EQUAL EMPLOYMENT OPPORTUNITY - GOALS AND TIMETABLES
FHWA-1273	SUPPLEMENT - EQUAL EMPLOYMENT OPPORTUNITY - FEDERAL STANDARDS
FHWA-1273	SUPPLEMENT - POSTERS AND NOTICES REQUIRED FOR FEDERAL-AID PROJECTS
FHWA-1273	SUPPLEMENT - WAGE RATE DETERMINATION
100-3	CONTRACTOR'S LICENSE
100-4	DEPARTMENT NAME CHANGE
102-2	ISSUANCE OF PROPOSALS
103-2	CONTACT INFORMATION FOR MOTORIST DAMAGE CLAIMS
105-4	MAINTENANCE DURING CONSTRUCTION
107-2	RESTRAINING CONDITIONS
108-1	LIQUIDATED DAMAGES
108-2	WORK ALLOWED PRIOR TO ISSUANCE OF WORK ORDER
108-3	WORK ORDER FOR FIXED COMPLETION DATE CONTRACTS
303-1	AGGREGATE BASE COURSE
306-1	QUALITY CONTROL AND ACCEPTANCE
400-1	TACK COATS
400-4	DESIGN AND QUALITY CONTROL OF ASPHALT MIXTURES
400-5	PERCENT AIR VOIDS FOR ACHM MIX DESIGNS
400-6	LIQUID ANTI-STRIP ADDITIVE
400-7	TRACKLESS TACK
404-3	DESIGN OF ASPHALT MIXTURES
409-2	ASPHALT LABORATORY FACILITY
410-1	CONSTRUCTION REQUIREMENTS AND ACCEPTANCE OF ASPHALT CONCRETE PLANT MIX COURSES
410-2	DEVICES FOR MEASURING DENSITY FOR ROLLING PATTERNS
410-4	EVALUATION OF ACHM SUBLOT REPLACEMENT MATERIAL
416-1	RECYCLED ASPHALT PAVEMENT
600-2	INCIDENTAL CONSTRUCTION
603-1	LANE CLOSURE NOTIFICATION
604-1	RETROREFLECTIVE SHEETING FOR TRAFFIC CONTROL DEVICES IN CONSTRUCTION ZONES
604-3	TRAFFIC CONTROL DEVICES IN CONSTRUCTION ZONES (MASH)
617-1	GUARDRAIL TERMINAL (TYPE 2)
617-2	GUARDRAIL DELINEATORS
802-4	CEMENT
JOB A80035	AGGREGATE SURFACE COURSE
JOB A80035	BIDDING REQUIREMENTS AND CONDITIONS
JOB A80035	BROADBAND INTERNET SERVICE FOR ASPHALT CONCRETE PLANT
JOB A80035	BUY AMERICA - CONSTRUCTION MATERIALS
JOB A80035	CARGO PREFERENCE ACT REQUIREMENTS
JOB A80035	COLD MILLING - MILL & INLAY
JOB A80035	DESIGN AND QUALITY CONTROL OF ASPHALT MIXTURES
JOB A80035	DESIGN OF ASPHALT MIXTURES - AGGREGATES
JOB A80035	DISADVANTAGED BUSINESS ENTERPRISE BIDDER'S RESPONSIBILITIES
JOB A80035	GOALS FOR DISADVANTAGED BUSINESS ENTERPRISE PARTICIPATION
JOB A80035	HIGH PERFORMANCE COLD MIX
JOB A80035	LIQUIDATED DAMAGES PROCEDURE FOR BID LETTINGS
JOB A80035	LONGITUDINAL JOINT DENSITIES FOR ACHM SURFACE COURSES
JOB A80035	MANDATORY ELECTRONIC CONTRACT
JOB A80035	MANDATORY ELECTRONIC DOCUMENT SUBMITTAL
JOB A80035	PERCENT AIR VOIDS AND NDESIGN FOR ACHM SURFACE MIX DESIGNS
JOB A80035	PRICE ADJUSTMENT FOR ASPHALT BINDER
JOB A80035	PRICE ADJUSTMENT FOR FUEL
JOB A80035	PROHIBITION OF CERTAIN TELECOMMUNICATIONS AND VIDEO SURVEILLANCE SERVICES OR EQUIPMENT
JOB A80035	RUMBLE STRIPS
JOB A80035	SUBMISSION OF ASPHALT CONCRETE HOT MIX ACCEPTANCE TEST RESULTS
JOB A80035	WARM MIX ASPHALT

GENERAL NOTES

1. THE CONTRACTOR SHALL BE RESPONSIBLE FOR MAINTAINING U. S. MAILBOXES WITHIN THE PROJECT LIMITS IN SUCH A MANNER THAT THE PUBLIC MAY RECEIVE CONTINUED MAIL SERVICE. PAYMENT WILL BE CONSIDERED INCLUDED IN THE PRICE BID FOR THE VARIOUS BID ITEMS.
2. THE EXISTING ASPHALT PAVEMENT TO BE REMOVED FROM THE REMAINING PAVEMENT SHALL BE SEPARATED BY SAWING ALONG A NEAT LINE. AFTER SAWING, THE PAVEMENT TO BE REMOVED SHALL BE CAREFULLY REMOVED IN A MANNER THAT WILL NOT DAMAGE THE PAVEMENT THAT IS TO REMAIN. ANY DAMAGE OF THE ASPHALT PAVEMENT THAT IS TO REMAIN IN PLACE SHALL BE REPAIRED AT THE CONTRACTOR'S EXPENSE.
3. THE CONTRACTOR SHALL PROVIDE 2-WAY RADIO COMMUNICATIONS FOR FLAG PERSONS.
4. STRINGLINE WILL BE USED TO MAINTAIN A UNIFORM HORIZONTAL ALIGNMENT.
5. THE CONTRACTOR SHALL FURNISH AND MAINTAIN STD. W8-1 "BUMP" SIGNS (30" X 30") WITH BLACK LEGEND ON ORANGE BACKGROUND AT ALL TRANSVERSE JOINTS EXPOSED TO TRAFFIC.
6. THE CONTRACTOR SHALL FURNISH AND MAINTAIN STD. W8-11 "UNEVEN LANES" SIGNS (48" X 48") WITH BLACK LEGEND ON ORANGE BACKGROUND AT ALL LONGITUDINAL JOINTS DURING MILLING AND PAVING OPERATIONS.
7. PREPARATORY WORK, SUCH AS CLIPPING THE GRASS AND DEBRIS FROM THE EDGE OF THE EXISTING ROADWAY, WILL NOT BE PAID FOR DIRECTLY BUT WILL BE CONSIDERED A PART OF THE OTHER ITEMS OF WORK. AFTER THE ROADWAY IS COMPLETED, THIS MATERIAL SHALL BE PULLED UP TO THE EDGE OF THE NEW PAVEMENT. HOWEVER, THIS MATERIAL SHALL BE PULLED UP TO THE EDGE OF THE NEW PAVEMENT IMMEDIATELY AT LOCATIONS WHERE DROP-OFFS GREATER THAN 4" RESULT FROM THE OVERLAY. NO DIRECT PAYMENT WILL BE MADE FOR THIS WORK.
8. THE EDGE LINES SHALL NOT BE PLACED ON THE FINISHED ASPHALT SURFACE UNTIL AFTER ALL WORK ADJACENT TO THE PAVEMENT EDGE, INCLUDING SPREADING, COMPACTING AND ETC. IS COMPLETED IN ORDER TO AVOID DAMAGING THE EDGE LINES.
9. BRIDGE ANALYSIS SHALL BE REQUIRED PER SECTION 105.14 OF THE STANDARD SPECIFICATIONS.
10. PRIOR TO OVERLAYING THE SHOULDERS AND DRIVING LANES, ALL UTILITY MANHOLES SHALL BE ADJUSTED TO MATCH THE FINAL SURFACE GRADE. THE ADJUSTMENT OF GRADE FOR UTILITY MANHOLES WILL NOT BE PAID DIRECTLY, BUT COMPENSATION SHALL BE CONSIDERED INCLUDED IN THE BID PRICES FOR THE CONTRACT'S PAY ITEMS.
11. TRAFFIC WILL BE ALLOWED ON MILLED SURFACES FOR A MAXIMUM OF 48 HOURS. IF ANY AREA PREVIOUSLY COLD MILLED HAS NOT BEEN OVERLAID WITHIN 48 HOURS, NO FURTHER COLD MILLING WILL BE ALLOWED UNTIL THE AREA HAS BEEN OVERLAID WITH 220 LB/SY OF ACHM SURFACE COURSE. THIS RESTRICTION MAY BE INCREASED, AT THE DISCRETION OF THE ENGINEER, UPON OBSERVATION OF SATISFACTORY RESULTS AND IF THERE ARE NO NEGATIVE IMPACTS TO THE TRAVELING PUBLIC.
12. CONSTRUCTION PAVEMENT MARKINGS FOR CENTERLINE AND EDGE LINES SHALL BE PLACED ON ANY MILLED SURFACE PRIOR TO OPENING THAT SURFACE TO TRAFFIC
13. BASE AND SUBGRADE FAILURES THAT BECOME APPARENT AFTER COLD MILLING OPERATIONS SHALL BE IMMEDIATELY REMEDIATED WITH ACHM PATCHING OF EXISTING ROADWAY.
14. THE CONTRACTOR SHALL SCHEDULE HIS WORK SO THAT NO LANE CLOSURES EXIST FOR THE TIME PERIOD OF THE DAY BEFORE THE HOLIDAY THROUGH THE DAY AFTER THE HOLIDAY FOR THE FOLLOWING LEGAL HOLIDAYS: NEW YEAR'S DAY, MEMORIAL DAY, INDEPENDENCE DAY, LABOR DAY, THANKSGIVING, AND CHRISTMAS. IF THE LEGAL HOLIDAY IS IMMEDIATELY BEFORE OR IMMEDIATELY FOLLOWING A WEEKEND, THE WEEKEND WILL BE CONSIDERED PART OF THE HOLIDAY.
15. ASPHALT DEBRIS RESULTING FROM THE PREPARATORY WORK SHALL BE REMOVED FROM THE PROJECT. THIS MATERIAL SHALL NOT BE BURIED WITHIN THE RIGHT OF WAY.
16. THE ENGINEER MAY REQUIRE THE CONTRACTOR TO MODIFY THEIR SCHEDULE, DURING WORK, WHEN SPECIAL EVENTS OR OCCURENCES MAY CAUSE TRAFFIC TO BECOME CONGESTED.

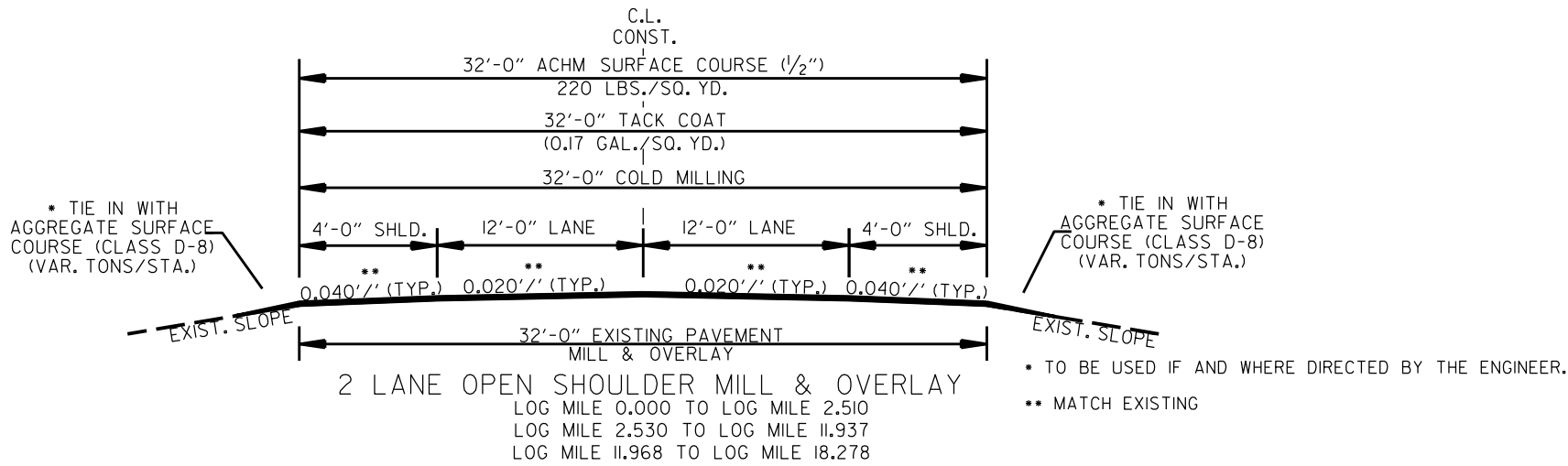

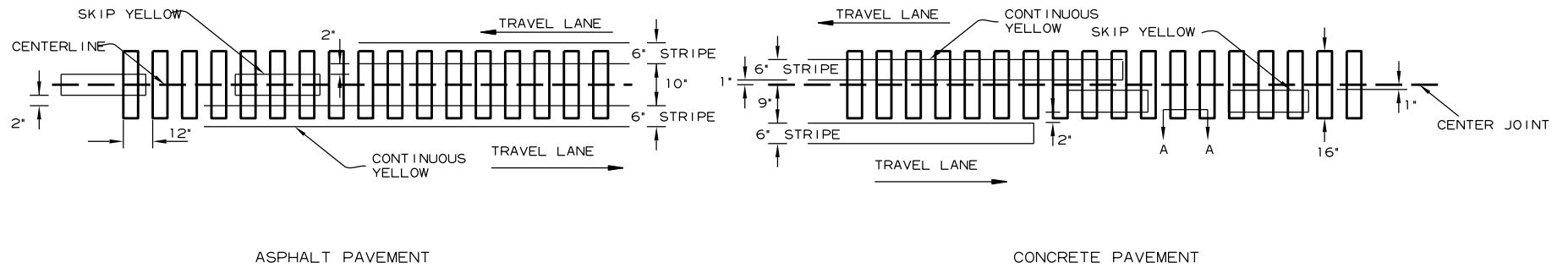

LOCATION PLAN OF CENTERLINE RUMBLE STRIPES

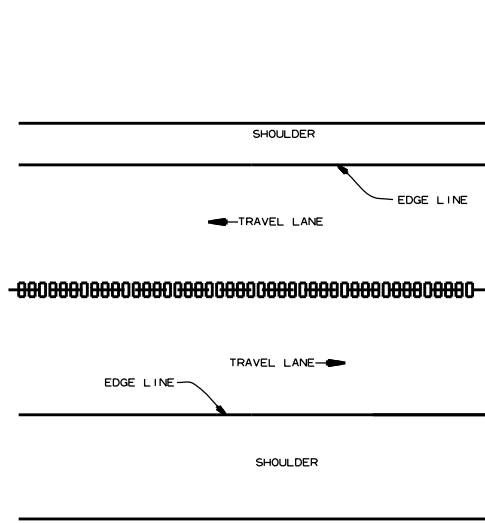

PLAN VIEW

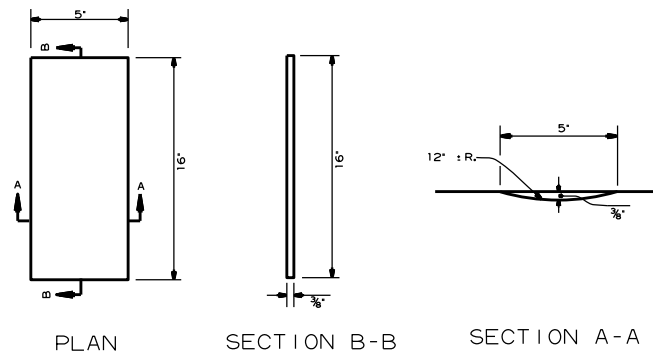

DETAILS OF CENTERLINE RUMBLE STRIPES

GENERAL NOTES

1. RUMBLE STRIPES SHALL NOT BE INSTALLED ON BRIDGE DECKS, APPROACH SLABS, INTERSECTING STREETS OR ROADWAYS, OR ACROSS TRANSVERSE JOINTS OF CONCRETE SHOULDERS.
2. RUMBLE STRIPES SHALL BE MEASURED BY THE LINEAR FOOT LONGITUDINALLY ALONG THE CENTERLINE.
3. THE 3/8" DEPTH SHALL GENERALLY APPLY FOR THE ENTIRE 16' LENGTH. SOME VARIATION TO SUIT SLOPE BREAKS MAY BE NECESSARY.

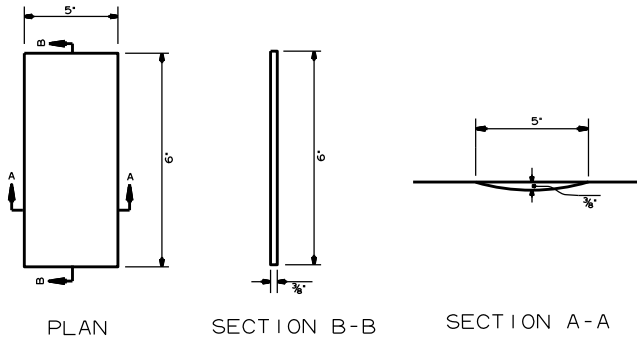

DETAILS OF RUMBLE STRIPE

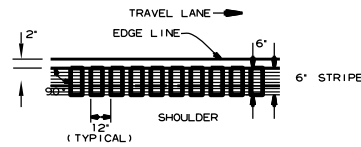

LOCATION PLAN OF RUMBLE STRIPE
LEFT OR RIGHT SHOULDER

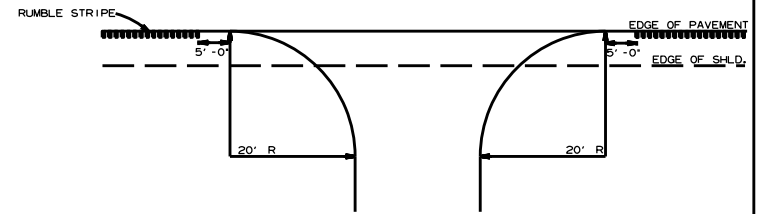

DETAIL FOR RUMBLE STRIPE GAP
AT DRIVEWAY TURNOUTS

GENERAL NOTES

1. RUMBLE STRIPES SHALL NOT BE INSTALLED ON BRIDGE DECKS, APPROACH SLABS, INTERSECTING STREETS OR ROADWAYS, RESIDENTIAL OR COMMERCIAL DRIVEWAYS OR ACROSS TRANSVERSE JOINTS OF CONCRETE SHOULDERS.
2. RUMBLE STRIPES SHALL NOT BE INSTALLED ON A PAVED SHOULDER THAT IS USED AS A DECELERATION LANE FOR THE LENGTH DEEMED APPROPRIATE BY THE ENGINEER.
3. RUMBLE STRIPES SHALL BE MEASURED BY THE LINEAR FOOT LONGITUDINALLY ALONG THE SHOULDER. PAYMENT SHALL ONLY INCLUDE THAT PORTION OF THE SHOULDER ON WHICH RUMBLE STRIPES HAVE BEEN CONSTRUCTED. NO MEASUREMENT OR PAYMENT WILL BE MADE FOR GAPS, DRIVEWAYS, TURNOUTS, OR OTHER PUBLIC ROAD INTERSECTIONS WHERE RUMBLE STRIPES HAVE NOT BEEN CONSTRUCTED.
4. THE 3/8" DEPTH SHALL GENERALLY APPLY FOR THE ENTIRE 6' LENGTH. SOME VARIATION TO SUIT SHOULDER SLOPE BREAKS MAY BE NECESSARY.

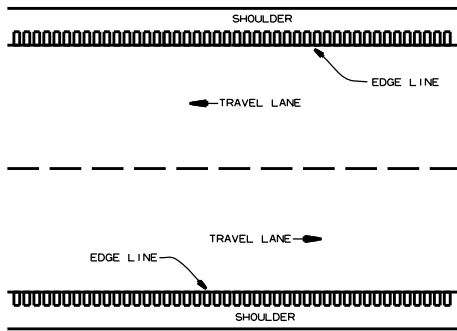

PLAN VIEW

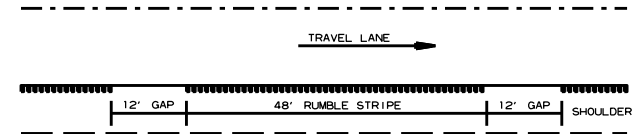

NOTE: GAP PATTERN SHALL BE ADJUSTED BY THE ENGINEER IN THE FIELD ALLOWING FOR DRIVEWAYS TO SERVE AS THE GAP.

DETAIL FOR GAP PATTERN RUMBLE STRIPE

ADVANCE WARNING SIGNS AND DEVICES

SIGN NUMBER	DESCRIPTION	SIGN SIZE	TOTAL SIGNS REQUIRED	
			NO.	SQ. FT.
W20-1	ROAD WORK 1500 FT.	48"x48"	2	32.0
W20-1	ROAD WORK 1000 FT.	48"x48"	2	32.0
W20-1	ROAD WORK 500 FT.	48"x48"	2	32.0
W20-1	ROAD WORK AHEAD	48"x48"	45	720.0
G20-2	END ROAD WORK	48"x24"	47	376.0
G20-1	ROAD WORK NEXT xx MILES	60"x24"	2	20.0
R4-1	DO NOT PASS	24"x30"	76	380.0
R4-2	PASS WITH CARE	24"x30"	58	290.0
TOTAL:				1882.0

NOTE: THIS IS A LOW TRAFFIC VOLUME ROAD AS DEFINED IN SECTION 604.03, STANDARD SPECIFICATIONS FOR HIGHWAY CONSTRUCTION.

CONSTRUCTION PAVEMENT MARKINGS AND PERMANENT PAVEMENT MARKINGS

DESCRIPTION	CONSTRUCTION PAVEMENT MARKINGS	RAISED PAVEMENT MARKERS		THERMOPLASTIC PAVEMENT MARKING				
		TYPE II (WHITE/RED)	TYPE II (YEL/YEL)	6"		12"	WORDS	ARROWS
				WHITE	YELLOW	WHITE		
LIN. FT.	EACH	WHITE	YELLOW	WHITE	LIN. FT.	EACH		
CONSTRUCTION PAVEMENT MARKINGS	649712							
RAISED PAVEMENT MARKERS TYPE II (WHITE/RED)		3						
RAISED PAVEMENT MARKERS TYPE II (YEL/YEL)			1209					
THERMOPLASTIC PAVEMENT MARKING WHITE (6")				192814				
THERMOPLASTIC PAVEMENT MARKING YELLOW (6")					132042			
THERMOPLASTIC PAVEMENT MARKING WHITE (12")						36		
THERMOPLASTIC PAVEMENT MARKING (WORDS)							1	
THERMOPLASTIC PAVEMENT MARKING (ARROWS)								1
TOTALS:	649712	3	1209	192814	132042	36	1	1

NOTE: THIS IS A LOW TRAFFIC VOLUME ROAD AS DEFINED IN SECTION 604.03, STANDARD SPECIFICATIONS FOR HIGHWAY CONSTRUCTION.

NOTE: THE PROJECT MUST BE MARKED FOR PASSING/NO PASSING ZONES PRIOR TO THE PLACEMENT OF ANY FINAL STRIPING.
CONTACT THE MAINTENANCE DIVISION AFTER THE FINAL LIFT OF SURFACE COURSE HAS BEEN PLACED TO SCHEDULE THE ZONING OF THE PROJECT.

COLD MILLING ASPHALT PAVEMENT

LOG MILE	LOG MILE	LOCATION	AVG. WIDTH	TOTAL LENGTH	COLD MILLING ASPHALT PAVEMENT
			FEET	FEET	SQ. YD.
0.000	2.510	HWY. 10 MAIN LANES	32.00	13252.80	47121.07
2.530	11.937	HWY. 10 MAIN LANES	32.00	49668.96	176600.75
11.968	18.278	HWY. 10 MAIN LANES	32.00	33316.80	118459.73
*ENTIRE PROJECT		*ADDITIONAL FOR CITY STREETS, COUNTY ROADS AND STATE HIGHWAY			*1397.00
TOTAL:					343578.55

*TO BE USED IF AND WHERE DIRECTED BY THE ENGINEER. SEE SECTION 104.03 OF THE STD. SPECS.

COORDINATE COLD MILLING STOCKPILE LOCATIONS WITH THE DISTRICT ENGINEER. STOCKPILE LOCATIONS SHALL BE NO FURTHER THAN 5 MILES FROM EACH SITE.

ASPHALT CONCRETE PATCHING FOR MAINTENANCE OF TRAFFIC

ACHM PATCHING OF EXISTING ROADWAY

DESCRIPTION	TON
ENTIRE PROJECT - TO BE USED IF AND WHERE DIRECTED BY THE ENGINEER	740
TOTAL:	740

NOTE: QUANTITY ESTIMATED.
SEE SECTION 104.03 OF THE STD. SPECS.

LOCATION	TON	TACK COAT
		GALLON
ENTIRE PROJECT - TO BE USED IF AND WHERE DIRECTED BY THE ENGINEER	458	916
TOTALS:	458	916

BASIS OF ESTIMATE:

ASPHALT CONCRETE PATCHING FOR MAINTENANCE OF TRAFFIC...25 TON/MILE
TACK COAT FOR MAINTENANCE OF TRAFFIC.....50 GAL./MILE

RUMBLE STRIPES

LOG MILE	LOG MILE	LOCATION	* RUMBLE STRIPES IN ASPHALT SHOULDERS	* CENTERLINE RUMBLE STRIPES IN ASPHALT ROADWAYS
			LIN.FT.	LIN.FT.
0.000	2.510	MAIN LANES	10603	13253
2.530	2.970	MAIN LANES	1859	2324
3.908	11.902	MAIN LANES	33767	42209
12.605	17.768	MAIN LANES	21809	27261
TOTALS:			68038	85047

* QUANTITY ESTIMATED.
SEE SECTION 104.03 OF THE STD. SPECS.

BASE AND SURFACING

LOG MILE	LOG MILE	LOCATION	LENGTH	AGGREGATE BASE COURSE (CLASS 7)	AGGREGATE SURFACE COURSE (CLASS D-8)	TACK COAT				ACHM SURFACE COURSE (1/2")				
						AVG. WID.	SQ.YD.	GALLONS / SQ.YD.	GALLON	AVG. WID.	SQ.YD.	POUND / SQ.YD.	PG 70-22	
						FEET	TON	TON	FEET	FEET	TON	TON	TON	
MAIN LANES														
0.000	2.510	HWY. 10 MAIN LANES	13252.80		*77	32.00	47121.07	0.17	8010.58	32.00	47121.07	220.00	5183.32	
2.530	11.937	HWY. 10 MAIN LANES	49668.96		*286	32.00	176600.75	0.17	30022.13	32.00	176600.75	220.00	19426.08	
11.968	18.278	HWY. 10 MAIN LANES	33316.80		*192	32.00	118459.73	0.17	20138.15	32.00	118459.73	220.00	13030.57	
* ADDITIONAL FOR TURNOUTS AND COUNTY ROADS														
*ENTIRE PROJECT					*50		VAR.	1397.00	0.17	237.49	VAR.	1397.00	220.00	*153.67
TOTALS:					*50		*555		343578.55		58408.35		343578.55	37793.64

BASIS OF ESTIMATE:

ACHM SURFACE COURSE (1/2").....93.8% MIN. AGGR.....6.2% ASPHALT BINDER

TACK COAT QUANTITIES WERE CALCULATED USING THE EMULSIFIED ASPHALT RATES. REFER TO SS-400-1 FOR THE RESIDUAL ASPHALT APPLICATION RATES.

* TO BE USED IF AND WHERE DIRECTED BY THE ENGINEER. SEE SECTION 104.03 OF THE STD. SPECS.

GUARDRAIL

LOG MILE	LOG MILE	LOCATION	GUARDRAIL (TYPE A)	THRIE BEAM GUARDRAIL TERMINAL	GUARDRAIL TERMINAL (TYPE 2)
			LIN. FT.	EACH	
2.482	2.510	HWY. 10 LT.	75	1	1
2.530	2.534	HWY. 10 LT.	125	1	1
2.530	2.558	HWY. 10 RT.	75	1	1
11.909	11.937	HWY. 10 LT.	75	1	1
11.968	12.002	HWY. 10 RT.	75	1	1
TOTALS:			425	5	5

NOTE: INSTALLATION OF THRIE BEAM GUARDRAIL TERMINAL WILL REQUIRE THE APPROPRIATE HOLES TO BE DRILLED IN EXISTING BRIDGE RAIL TO FACILITATE BOLTING OF THRIE BEAM TO RAIL. NO DIRECT PAYMENT WILL BE MADE FOR DRILLING OF NEW HOLES; PAYMENT WILL BE CONSIDERED INCLUDED IN THE PRICE BID FOR THRIE BEAM GUARDRAIL TERMINAL.

REMOVAL AND DISPOSAL OF ITEMS

LOG MILE	LOG MILE	LOCATION	GUARDRAIL
			LIN. FT.
2.494	2.510	HWY. 10 LT	85
2.530	2.568	HWY. 10 LT	200
2.530	2.546	HWY. 10 RT	85
11.923	11.937	HWY. 10 LT.	75
11.968	11.988	HWY. 10 RT.	75
TOTAL:			520

NOTE: THE QUANTITY SHOWN ABOVE FOR THE REMOVAL AND DISPOSAL OF GUARDRAIL SHALL INCLUDE THE REMOVAL AND DISPOSAL OF ALL GUARDRAIL TERMINALS AND TERMINAL ANCHOR POSTS.

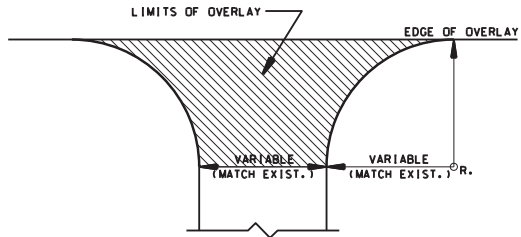

DETAIL FOR STATE HIGHWAY TURNOUTS
(PAVEMENT PRESERVATION)

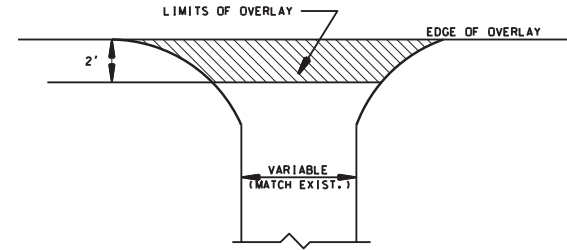

DETAIL FOR DRIVEWAY TURNOUTS
(PAVEMENT PRESERVATION)

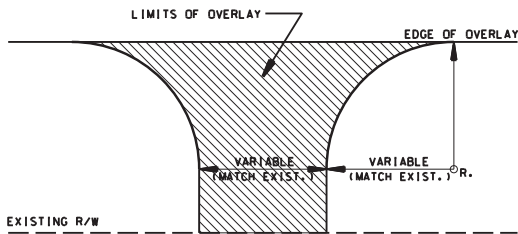

DETAIL FOR CITY STREET
AND COUNTY ROAD TURNOUTS
(PAVEMENT PRESERVATION)

NOTES:

1. TURNOUTS AND PRIVATE DRIVES SHALL BE MODIFIED WHERE NECESSARY TO MEET LOCAL CONDITIONS AS DIRECTED BY THE ENGINEER.
2. NORMAL ACHM SURFACE COURSE (1/2" (220 LBS PER SQ. YD.) SHALL BE USED ON DRIVEWAYS AND TURNOUTS UNLESS SHOWN OTHERWISE IN THE PLANS.
3. STATE HIGHWAY TURNOUTS SHALL BE PAVED TO THE BACK OF THE RADIUS.
4. CITY STREET AND COUNTY ROAD TURNOUTS SHALL BE PAVED TO THE RIGHT-OF-WAY LIMITS.

4-13-23			REVISED PAVING AT TURNOUTS
5-19-22			ISSUED
DATE REV	DATE FILMED		DESCRIPTION

ARKANSAS STATE HIGHWAY COMMISSION
DETAILS OF DRIVEWAYS & STREET
TURNOUTS (PAVEMENT PRESERVATION)
STANDARD DRAWING DR-3

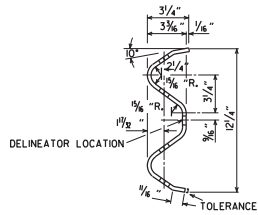
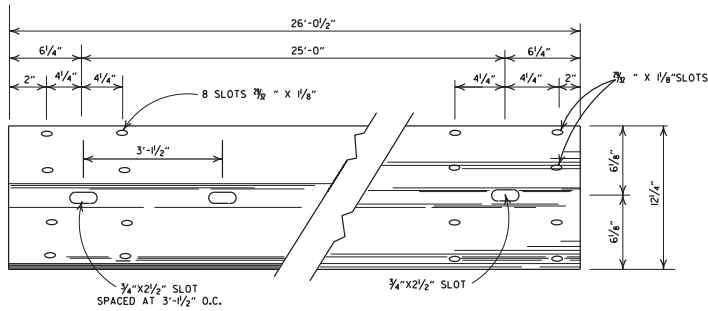

DETAILS OF W-BEAM GUARDRAIL

RAIL SECTION OF CLOSELY SIMILAR DIMENSIONS AND COMPARABLE STRENGTH MAY BE SUBSTITUTED IF APPROVED BY THE ENGINEER.

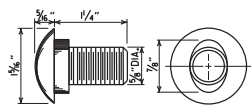

SPLICE BOLT POST BOLT - SAME EXCEPT LENGTH

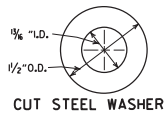

CUT STEEL WASHER

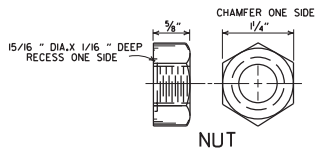

NUT

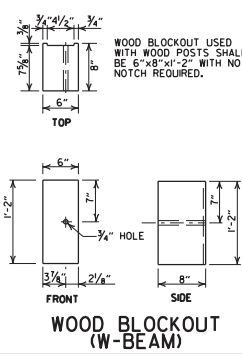

WOOD BLOCKOUT (W-BEAM)

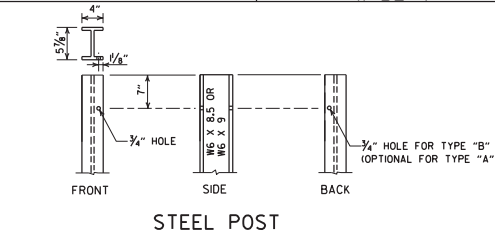

STEEL POST

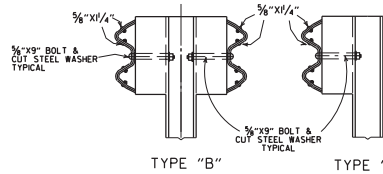

DETAILS OF STEEL LINE POST CONNECTIONS (W-BEAM)

-GENERAL NOTES-

ALL BOLTS SHALL BE SUFFICIENT LENGTH TO EXTEND THROUGH THE FULL THICKNESS OF THE NUT AND NO MORE THAN 3/4" BEYOND IT.

WHERE W-BEAM GUARDRAIL CONTIGUES, THE INTERMEDIATE SECTIONS SHALL HAVE A POST SPACING OF 6'-3" UNLESS OTHERWISE NOTED.

W-BEAM GUARDRAIL REPRESENTING INTERMEDIATE SECTIONS WILL BE MEASURED ALONG THE ROADWAY FACE FROM CENTERLINE OF POST TO CENTERLINE OF POST.

USE W-BEAM GUARDRAIL COMPONENTS OF SAME MATERIAL FOR ENTIRE JOB. FOR EXTENSIONS OR MODIFICATION OF EXISTING GUARDRAIL, W-BEAM GUARDRAIL COMPONENTS OF THE SAME TYPE AS THOSE EXISTING SHALL BE USED.

ANY BACKFILLING UNDER OR AROUND POST SHALL BE DAMP SAND THOROUGHLY TAMPED IN PLACE.

WOOD POSTS & WOOD BLOCKS SHALL BE EITHER DENSE NO. 1 STRUCTURAL OR BETTER S.P. (WOOD P) OR NO. 1,1550 F SOUTHERN PINE.

CONTRACTOR SHALL HAVE THE OPTION OF USING WOOD BLOCKOUTS FOR W-BEAM GUARDRAIL OR PLASTIC BLOCKOUTS, AS LONG AS BLOCKOUT USED MEETS REQUIREMENTS FOR MANUAL FOR ASSESSING SAFETY HARDWARE (MASH) FOR W-BEAM GUARDRAIL.

DELINEATORS SHALL BE MOUNTED AT 37.5' SPACING ON THE FRONT FACE OF THE GUARDRAIL. SPACING MAY BE REDUCED IN CURVES, AS DIRECTED BY THE ENGINEER. COLOR SHALL BE IN ACCORDANCE WITH THE MANUAL ON UNIFORM TRAFFIC CONTROL DEVICES. PAYMENT FOR DELINEATORS SHALL BE CONSIDERED INCLUDED IN THE PRICE BID PER LIN. FT. FOR GUARDRAIL.

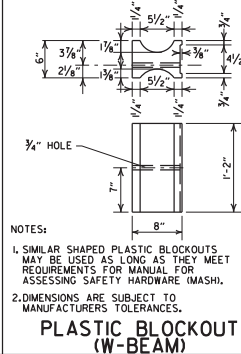

PLASTIC BLOCKOUT (W-BEAM)

NOTES:
1. SIMILAR SHAPED PLASTIC BLOCKOUTS MAY BE USED AS LONG AS THEY MEET REQUIREMENTS FOR MANUAL FOR ASSESSING SAFETY HARDWARE (MASH).
2. DIMENSIONS ARE SUBJECT TO MANUFACTURERS TOLERANCES.

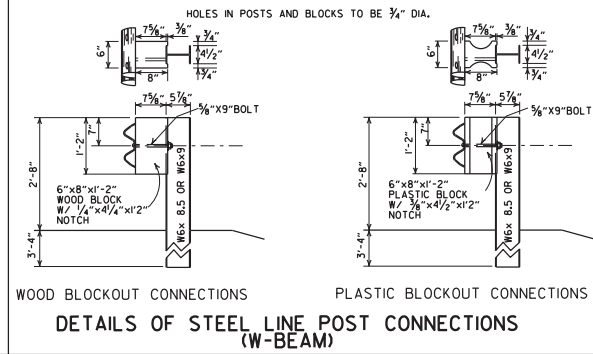

WOOD BLOCKOUT CONNECTIONS PLASTIC BLOCKOUT CONNECTIONS
DETAILS OF STEEL LINE POST CONNECTIONS (W-BEAM)

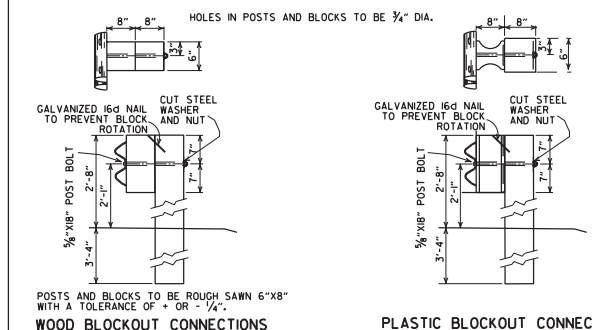

WOOD BLOCKOUT CONNECTIONS PLASTIC BLOCKOUT CONNECTIONS
DETAILS OF WOOD LINE POST CONNECTIONS (W-BEAM)

05-19-22	REVISED GENERAL NOTES.	
05-07-19	ADDED DELINEATOR LOCATION, RENUMBERED AND RENAMED	
11-16-17	REVISED GENERAL NOTES AND RAISED GUARDRAIL HEIGHT 3"	
07-14-10	RAISED HEIGHT OF GUARDRAIL 1"	
10-15-09	ADDED REFERENCE TO MASH	
04-10-03	REVISED GENERAL NOTES	
08-22-02	REVISED DIMENSION ON WOOD & PLASTIC BLOCKOUT CONNECTIONS & STEEL POST	
11-16-01	REVISED WOOD BLOCKOUT & DETAILS OF WOOD LINE POST CONNECTIONS	
03-30-00	REMOVED GUARDRAIL AT BRIDGE ENDS	
01-12-99	ADDED PLASTIC BLOCKOUT	
08-12-98	REV. BLOCKOUTS TO WOOD, DELETED CONC. POST & REV. GENERAL NOTE, DELETED DET. OF GUARDRAIL REFACE BEHIND CURB & DET. OF POST PLACE IN SOLID ROCK & ADDED DETAILS OF STEEL LINE POST CONN. REMOVED BACK-UP PLATE, REVISED HOLES IN STEEL POLES	
04-03-97	REMOVED "LAP IN DIRECTION OF TRAFFIC" NOTE & PLACED ARROWS ON WASHERS	
10-18-96	REVISED WOOD POST NOTE	
08-02-94	ADDED ALL STEEL POST SIZE	
08-05-93	REVISED STEEL POST SIZE	8-5-93
10-01-92	REDRAWN & REVISED	10-1-92
08-15-91	REVISED WASHER NOTE	8-5-91
08-02-90	REV. GEN. NOTE & DEPTH OF ANC. POST IN ROCK	8-2-90
07-15-88	REVISED SECTION 3 & GENERAL NOTES	
03-04-88	REV. ANCHOR POST ELEV. NOTES & POST IN ROCK	780-3-4-88
10-30-87	REVISED WOOD LINE POST DETAIL	546-10-30-87
10-09-87	REDRAWN & REVISED	802-10-9-87
DATE	REVISION	FILED

ARKANSAS STATE HIGHWAY COMMISSION
GUARDRAIL DETAILS
STANDARD DRAWING GR-6

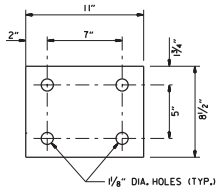

WASHER PLATE

Note: Bolts, nuts, washers and plates shall be galvanized in accordance with Section 807 of the Standard Specifications.

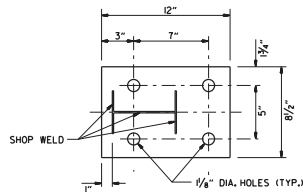

BASE PLATE

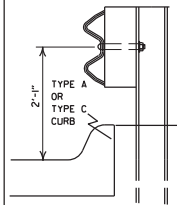

FOR DESIGN SPEEDS OF 50 MPH OR LESS
ALIGN FACE OF GUARDRAIL WITH FACE OF CURB.

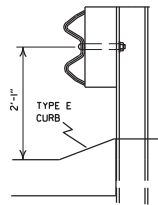

FOR DESIGN SPEEDS OF 55 MPH OR MORE
PLACE GUARDRAIL POSTS AGAINST BACK OF CURB.

DETAIL OF GUARDRAIL PLACEMENT BEHIND CURB (W-BEAM)

FOR DESIGN SPEEDS OF 50 MPH OR LESS ALL CURB FACES, AS SHOWN ON STD. DRWG. CG-1, MAY BE USED. FOR DESIGN SPEEDS OF 55 MPH OR MORE TYPE "E" CURB FACE SHALL BE USED.

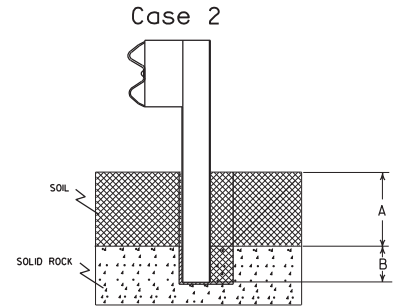
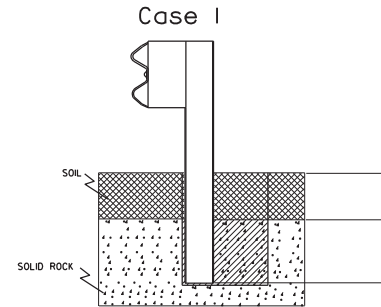

Plan View Steel Posts

Either hole configuration acceptable

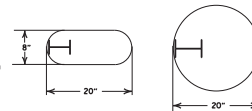

Plan View Wood Posts

Either hole configuration acceptable

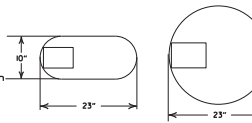

Notes: For overlying soil depths (A) ranging from 0 to 18", the depth of required drilling (B) is equal to 24".

Zone A:
Backfill according to Section 617.03(a).

Zone B:
Backfill in 6" lifts with material meeting the requirements of Section 802.02(c) - Alternate gradation, Compact to 95% maximum dry density per ASTM D-698.

Notes: For overlying soil depths (A) ranging from 18" to 44", the depth of required drilling (B) is equal to either 12" or 44" minus the depth of soil whichever is less.

Zone A & B:
Backfill according to Section 617.03(a).

DETAIL OF POST PLACEMENT IN SOLID ROCK (W-BEAM)

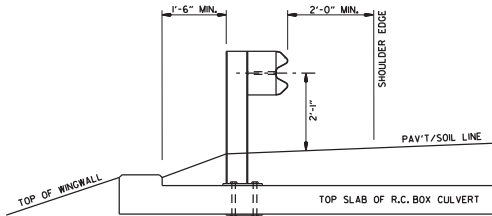

SECTION A-A

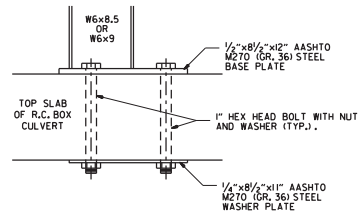

DETAIL OF CONNECTION

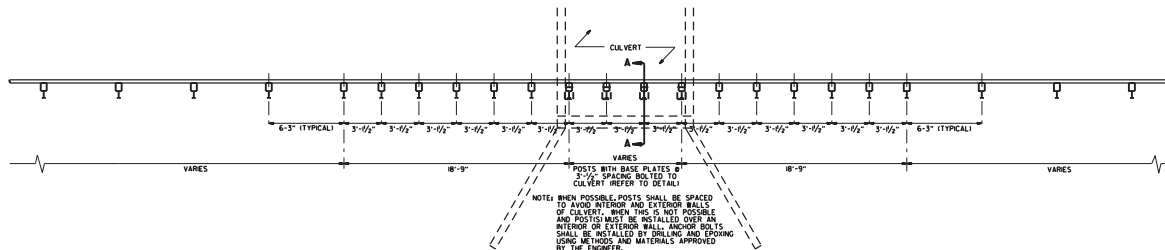

PLAN LAYOUT OF TYPE A GUARDRAIL AT LOW-FILL CULVERTS

NOTE: THIS DETAIL IS TO BE USED ONLY WHEN THE COVER OVER THE CULVERT DOES NOT PERMIT FULL EMBEDMENT OF GUARDRAIL POSTS AS SHOWN ON STD. DRWG. GR-6.

DATE	REVISION	FILED
11-07-19	RENUMBERED, RENAMED, REVISED REFERENCE	
11-16-17	REVISED GUARDRAIL HEIGHT	
07-14-10	RAISED HEIGHT OF GUARDRAIL 1"	
04-12-07	REVISED DETAIL OF GUARDRAIL PLACEMENT BEHIND CURB	
11-10-05	ADDED GUARDRAIL PLACEMENT BEHIND CURB; REVISED DETAIL OF CONNECTION	
11-18-04	REVISED POST PLACEMENT IN ROCK & CULVERT CONNECTION DETAILS, ADDED DETAIL FOR GUARDRAIL PLACEMENT AT LOW-FILL CULVERTS	
03-30-00	ADDED GUARDRAIL PLACEMENT BEHIND CURB; REVISED DETAIL OF CONNECTION	
08-12-98	CHANGED STEEL SPACER BLOCK TO WOOD BLOCKOUT, ADDED DET. OF GUARDRAIL CONNECTION TO R.C. BOX CULV'T., DELETED DET. OF STEEL LINE POST CONN. & ADDED DET. OF GUARDRAIL PLACE BEHIND CURB & DET. OF POSTPLACE IN SOLID ROCK	
04-03-96	PLACED ARROWS AT CUT STEEL WASHERS	4-3-96
0-18-96	REV. ASTM REF. TO AASHTO	
8-22-95	ADDED OPTIONAL HOLES	
08-10-94	REVISED ALTERNATE POST SIZE	
08-08-93	REVISED STEEL POST SIZE	
10-01-92	REDRAWN & REVISED	10-1-92
08-02-90	DEL. WASHER ON ANCHOR ASSEMBLY	8-2-90
07-15-88	CONFORMED TO 1988 SPECS	
03-04-88	REVISED ANCHOR NOTE	
10-30-87	REVISED ANCHOR ASSEMBLY	712-10-30-87
10-30-87	REVISED PLACEMENT BEHIND CURB	547-10-30-87
10-09-87	REDRAWN & REVISED	803-10-9-87

ARKANSAS STATE HIGHWAY COMMISSION
GUARDRAIL DETAILS
STANDARD DRAWING GR-7

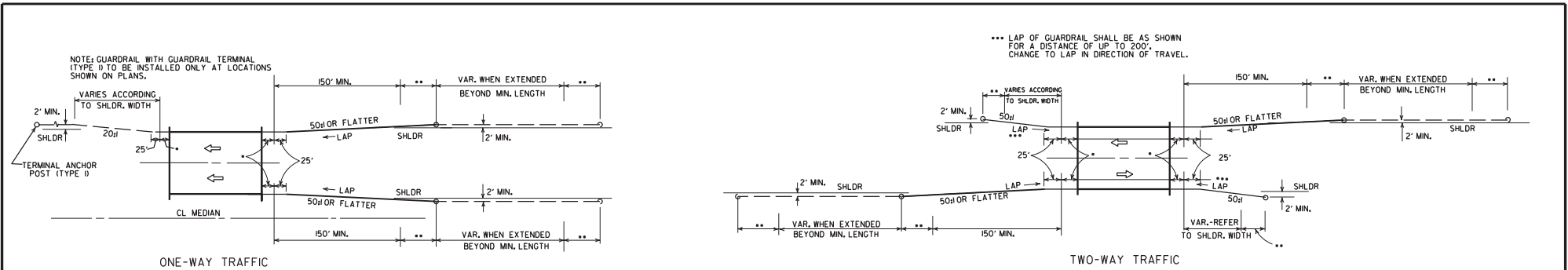

METHODS OF INSTALLATION OF GUARDRAIL AT LESS THAN FULL SHOULDER WIDTH BRIDGES USING GUARDRAIL TERMINAL (TYPE 2)

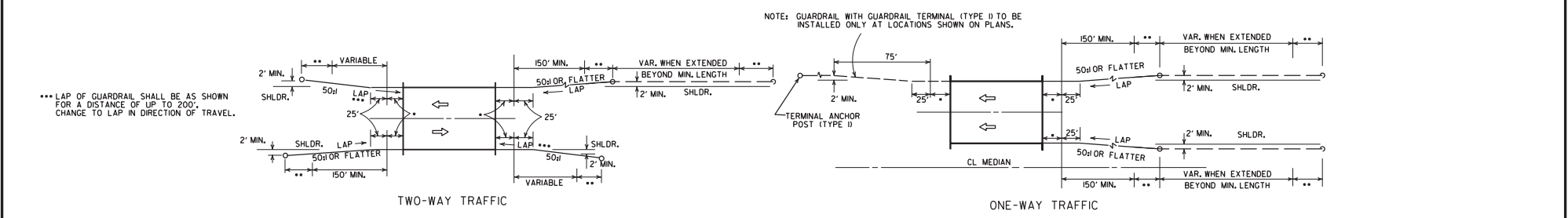

METHOD OF INSTALLATION OF GUARDRAIL AT FULL SHOULDER WIDTH BRIDGES USING GUARDRAIL TERMINAL (TYPE 2)

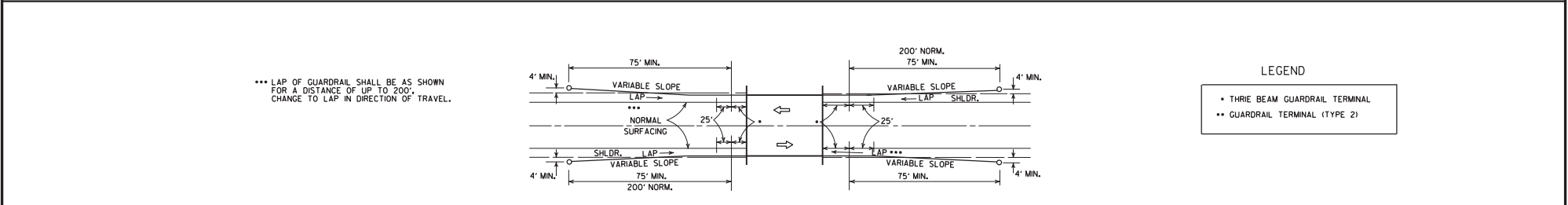

METHOD OF INSTALLATION OF GUARDRAIL USING GUARDRAIL TERMINAL (TYPE 1) (FULL SHOULDER WIDTH OR LESS BRIDGES)

			ARKANSAS STATE HIGHWAY COMMISSION
			GUARDRAIL DETAILS
			STANDARD DRAWING GR-8
11-07-19	RENUMBERED AND RENAMED		
7-17-08	REVISED LAYOUTS		
11-10-05	REMOVED GUARDRAIL NOTES AND DETAILS		
11-16-01	DELETED NOTE-METHOD OF INSTALLATION OF GUARDRAIL USING GUARDRAIL TERM. (TY. 1)		
1-12-00	ADDED CONSTRUCTION NOTE	1-12-00	
6-26-97	REVISED LAYOUT		
10-1-92	REDRAWN & REVISED	10-1-92	
	ADDED NOTE		
10-3-87	REDRAWN & REVISED		
DATE	REVISION	DATE	FILE

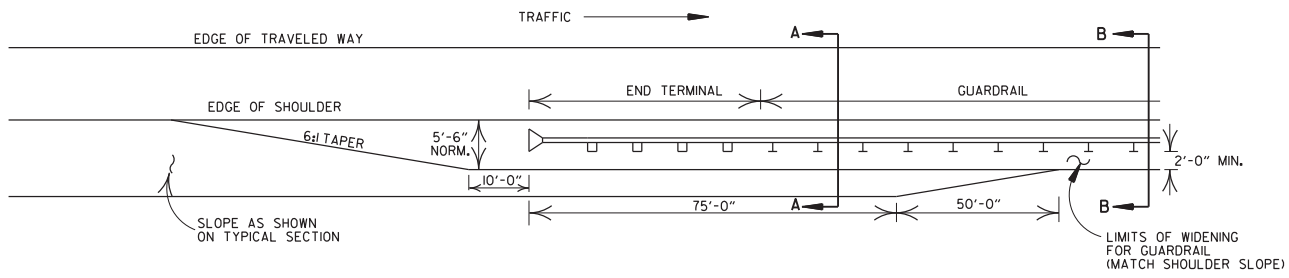

NOTE: NORMAL SECTION TO BE WIDENED APPROX. 5'-6" EACH SIDE TO SUPPORT GUARDRAIL.

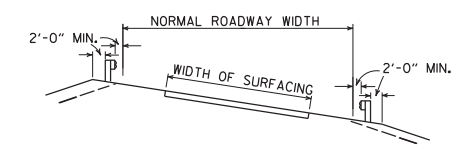
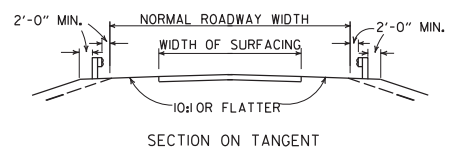

DETAILS SHOWING POSITION OF GUARDRAIL ON HIGHWAY

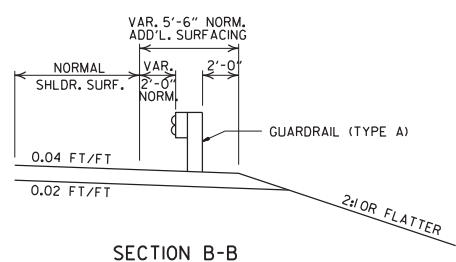
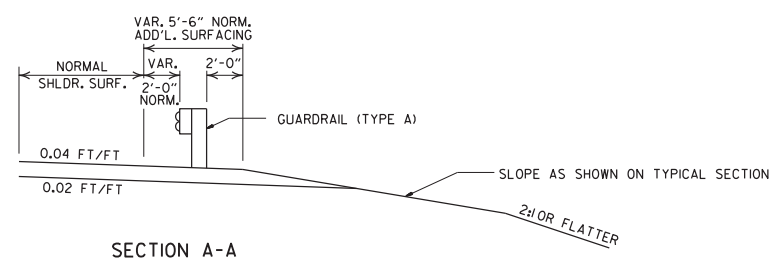

DETAILS OF WIDENING FOR GUARDRAIL

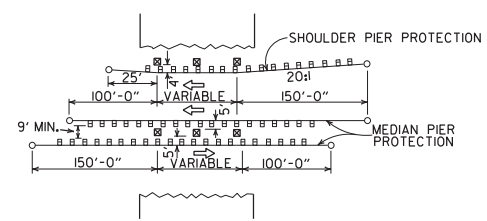

METHOD OF INSTALLATION OF GUARDRAIL AT FIXED OBSTACLE

ARKANSAS STATE HIGHWAY COMMISSION			
GUARDRAIL DETAILS			
STANDARD DRAWING GR-9			
11-07-19	RENUMBERED AND RENAMED		
4-17-08	MINOR REVISION		
11-10-05	DRAWN		
DATE	REVISION		DATE FILED

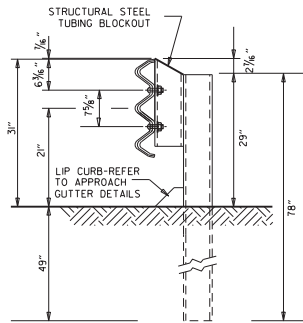

THRIE BEAM RAIL WITH STEEL TUBING BLOCKOUT AND STEEL POST
POSTS 1-7

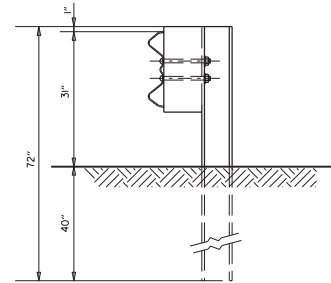

W-BEAM TO THRIE BEAM TRANSITION RAIL WITH WOOD OR PLASTIC BLOCKOUT AND STEEL POST
POST 8

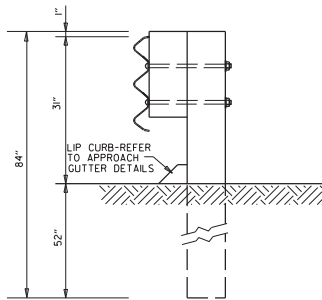

THRIE BEAM RAIL WITH WOOD OR PLASTIC BLOCKOUTS & WOOD POSTS
POSTS 1-6

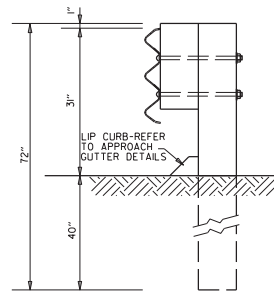

THRIE BEAM RAIL WITH WOOD OR PLASTIC BLOCKOUT & WOOD POST
POST 7

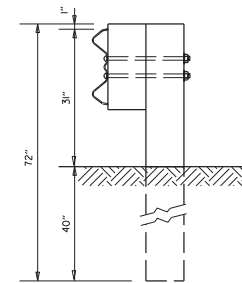

W-BEAM TO THRIE BEAM TRANSITION RAIL WITH WOOD OR PLASTIC BLOCKOUT & WOOD POST
POST 8

GENERAL NOTES:
RAIL POSTS SHALL BE SET PERPENDICULAR TO THE ROADWAY PROFILE GRADE AND VERTICALLY IN CROSS SECTION.

WOOD POSTS & WOOD BLOCKS SHALL BE EITHER DENSE NO. 1 STRUCTURAL OR BETTER 3,7 F (400 F) OR NO. 1 1350 F SOUTHERN PINE.

			ARKANSAS STATE HIGHWAY COMMISSION
11-07-18	RENAMED		GUARDRAIL DETAILS
11-16-17	REVISED GUARDRAIL HEIGHT, CHANGED STD. DWG. NUMBER FROM GR-10A TO GR-11		
07-14-10	REVISED POST 8 DIMENSIONS		
11-29-07	ADDED PLASTIC BLOCKOUTS		
08-22-02	REVISED LIP CURB NOTE		
03-30-00	DRAWN & ISSUED		STANDARD DRAWING GR-11
DATE	REVISION	FILMED	

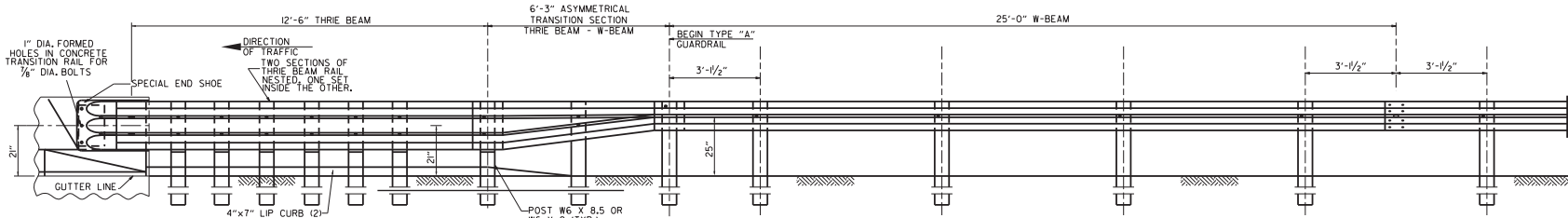

ELEVATION

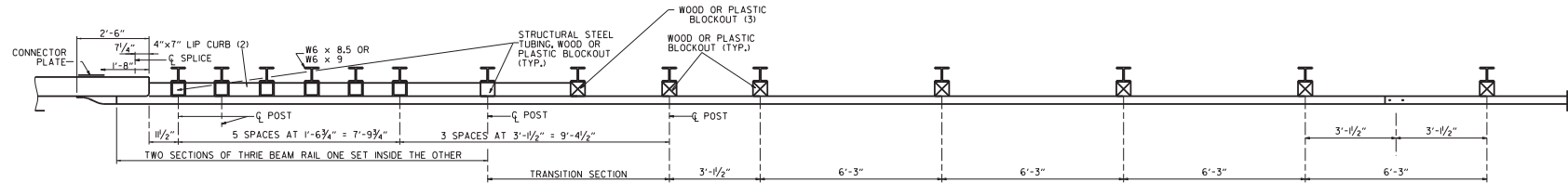

PLAN

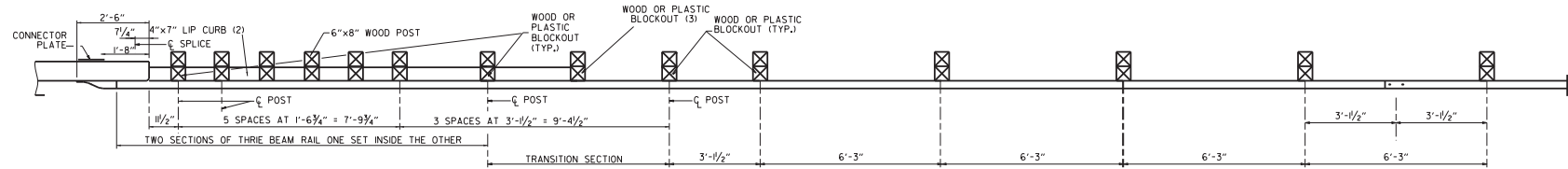

PLAN

- (1) VERIFY BOLT SPACING FROM RAIL TRANSITION PRODUCER.
- (2) REFER TO APPROACH GUTTER DETAILS.
- (3) LENGTH OF BLOCKOUT ON POST 8 TO BE MODIFIED TO FIT RAIL WIDTH.

THRIE BEAM GUARDRAIL CONNECTION AT BRIDGE ENDS

GENERAL NOTES:

THE THRIE BEAM RAIL, SPECIAL END SHOE, AND THE TRANSITION SECTION SHALL BE MADE OF STEEL AND SHALL BE 12 GAGE. ZINC COATING SHALL BE TYPE L.

RAIL POSTS SHALL BE SET PERPENDICULAR TO THE ROADWAY PROFILE GRADE AND VERTICALLY IN CROSS SECTION.

ALL BOLTS SHALL BE SUFFICIENT LENGTH TO EXTEND THROUGH THE FULL THICKNESS OF THE NUT AND NO MORE THAN 3/4" BEYOND IT.

ALL LAP SPLICES, INCLUDING SPECIAL END SHOES, SHALL BE MADE IN THE DIRECTION SHOWN ON STANDARD DRAWINGS GR-8 & GR-13.

REFER TO STD. DRWG. GR-11 FOR POST DETAILS.

USE THRIE BEAM GUARDRAIL COMPONENTS OF SAME MATERIAL FOR ENTIRE JOB.

THRIE BEAM POSTS SHALL BE SAME MATERIAL AS W-BEAM POSTS FOR ENTIRE JOB.

POSTS SHALL NOT BE PLACED AT SPLICE LOCATIONS ALONG W-BEAM RAILS.

WOOD POSTS & WOOD BLOCKS SHALL BE EITHER DENSE NO. 1 STRUCTURAL OR BETTER 9.1F (400 F) OR NO. 1350 F SOUTHERN PINE.

			ARKANSAS STATE HIGHWAY COMMISSION
			GUARDRAIL DETAILS
05-14-20	REVISED NOTES		
11-07-19	RENAMED & REVISED REFERENCES		
11-16-17	RE-DRAWN FROM STD. DRWG. GR-10 & ISSUED		
DATE	REVISION	FILMED	STANDARD DRAWING GR-12

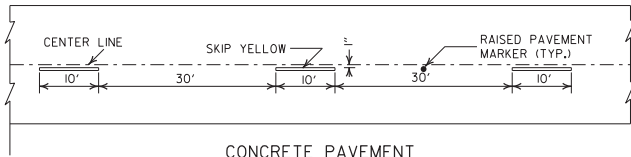

CONCRETE PAVEMENT

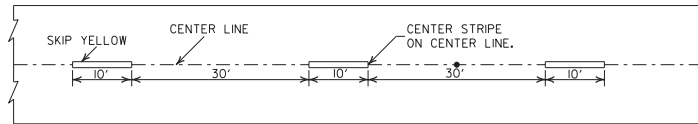

ASPHALT PAVEMENT

BROKEN LINE STRIPING

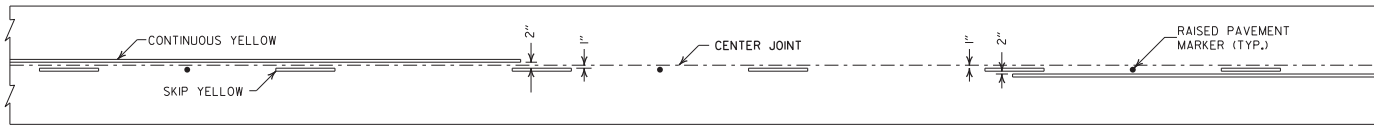

SOLID LINE STRIPING ON CONCRETE PAVEMENT

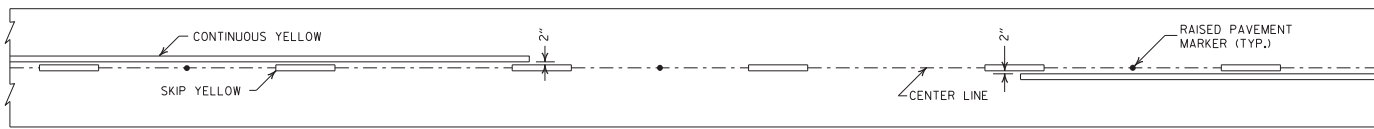

SOLID LINE STRIPING ON ASPHALT PAVEMENT

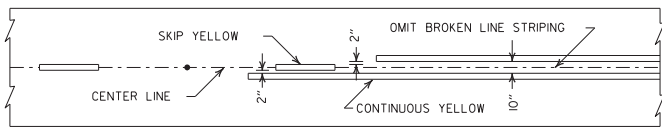

ASPHALT PAVEMENT

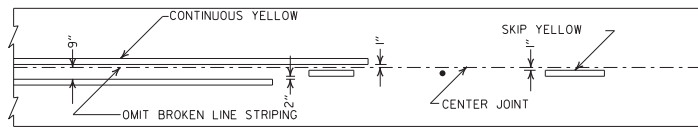

CONCRETE PAVEMENT

STRIPING AT ADJACENT NO PASSING LANES

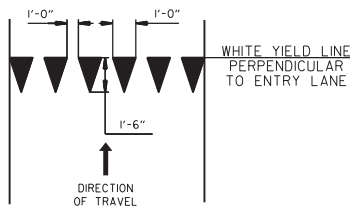

YIELD LINE DETAIL

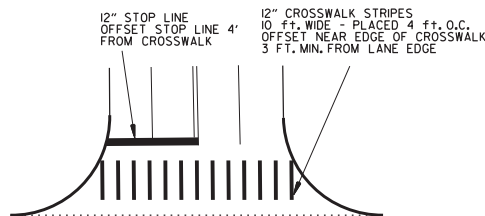

CROSSWALK AND STOP LINE DETAILS

- NOTES:
- REFER TO THE STRIPING DETAILS FOR PAVEMENT MARKING LINE WIDTHS.
 - THIS DRAWING SHALL BE USED IN CONJUNCTION WITH THE LATEST REVISED ADDITION OF THE "MANUAL ON UNIFORM TRAFFIC CONTROL DEVICES."
 - RAISED PAVEMENT MARKERS SHALL BE PLACED ON AN 80 FEET SPACING UNLESS OTHERWISE SHOWN IN THE PLANS.

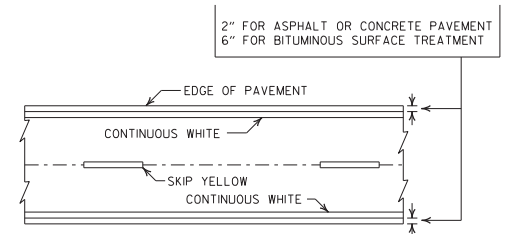

PAVEMENT EDGE LINE MARKING

NOTE:
THE RED LENS OF THE TYPE II R.P.M. SHALL FACE THE INCORRECT TRAFFIC MOVEMENT.

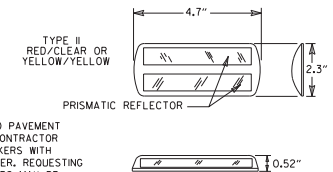

NOTE:
DIMENSIONS SHOWN FOR RAISED PAVEMENT MARKERS ARE TYPICAL. THE CONTRACTOR MAY SUBSTITUTE SIMILAR MARKERS WITH THE APPROVAL OF THE ENGINEER. REQUESTING APPROVAL FOR SIMILAR MARKERS MAY BE MADE BY REFERRING TO THE ARDOT QUALIFIED PRODUCTS LIST.















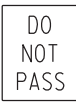



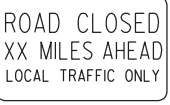





















DETAIL OF STANDARD RAISED PAVEMENT MARKERS

DATE	REVISION	FILMED
2-27-20	REVISED STOP LINE DETAILS	
6-1-17	ADDED YIELD LINE DETAIL	
5-12-16	REVISED LINE WIDTHS, SPACING, & NOTES	
9-12-13	REVISED DETAIL OF STANDARD RAISED PAVEMENT MARKERS	
11-17-10	REVISED GENERAL NOTES & REMOVED FLOWABLE PAVT. MRKRS	
11-18-04	REVISED NOTE 2 & GENERAL NOTES	
8-22-02	ADDED CROSSWALK & STOPBAR DTLs.	
7-02-98	ADDED DETAILS OF STD. RAISED PAVT. MARKERS	
4-26-96	REV. NOTES 3&4 ADDED R.P.M.	
9-30-80	DRAWN	1-9-30-80

ARKANSAS STATE HIGHWAY COMMISSION

PAVEMENT MARKING DETAILS

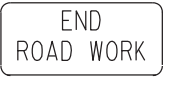
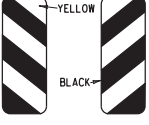
STANDARD DRAWING PM-1

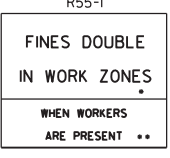
<p>RI-1</p>  <p>STANDARD 30"x30" EXPWAY 36"x36" SPECIAL 48"x48"</p>	<p>RI-2</p>  <p>STD. 36"x36"x36" EXPWY. 48"x48"x48" FWY. 60"x60"x60"</p>	<p>R2-1</p>  <p>STD. 24"x30" EXPWY. 36"x48" FWY. 48"x60"</p>	<p>W3-5</p>  <p>STD. 36"x36" EXPWY. 48"x48" FWY. 48"x48"</p>	<p>W3-5a</p>  <p>STD. 36"x36" EXPWY. 48"x48" FWY. 48"x48"</p>	<p>R4-1</p>  <p>STD. 24"x30" EXPWY. 36"x48" FWY. 48"x60"</p>	<p>R4-2</p>  <p>STD. 24"x30" EXPWY. 36"x48" FWY. 48"x60"</p>	<p>ADVANCE DISTANCES (XXXX)</p> <p>500 FT 1/2 MILE 1000 FT 3/4 MILE 1500 FT 1 MILE AHEAD</p> <p>GENERAL NOTES: 1. ALL TRAFFIC CONTROL DEVICES USED ON ROAD CONSTRUCTION SHALL CONFORM TO THE MANUAL ON UNIFORM TRAFFIC CONTROL DEVICES, LATEST EDITION, AND TO THE STANDARD HIGHWAY SIGNS, LATEST EDITION, OR AS APPROVED BY THE FEDERAL HIGHWAY ADMINISTRATION. 2. TRAFFIC CONTROL DEVICES SHALL BE SET UP JUST BEFORE THE START OF CONSTRUCTION OPERATIONS AND SHALL BE PROPERLY MAINTAINED DURING THE TIME SUCH CONDITIONS EXIST. THEY SHALL REMAIN IN PLACE ONLY AS LONG AS NEEDED AND REMOVED THEREAFTER. 3. EXISTING SIGNS AND CONSTRUCTION SIGNS SHALL BE KEPT IN PROPER POSITION, AND BE CLEAN AND LEGIBLE AT ALL TIMES. SIGNS THAT DO NOT APPLY TO EXISTING CONDITIONS SHALL BE REMOVED. SIGNS THAT ARE DAMAGED, DETAILED, OR THAT ACCUMULATE DIRT DURING CONSTRUCTION SHALL BE CLEANED, REPAIRED, OR REPLACED. 4. SIGNS ARE USUALLY MOUNTED ON A SINGLE POST, ALTHOUGH THOSE WIDER THAN 36" OR LARGER THAN 10 SQ. FT. SHALL BE MOUNTED ON TWO POSTS OR ABOVE A TYPE III BARRICADE. 5. SIGN POSTS DIRECT BURIED IN SOIL SHALL BE 2 LB. MINIMUM CHANNEL POST OR 4"x4" WOOD POSTS. CHANNEL POSTS SHALL BE PAINTED GREEN. WOOD POSTS SHALL BE PAINTED WHITE. ALL POSTS SHALL BE NEATLY CONSTRUCTED, AND SHALL BE REPLUMBED, CLEANED, OR REPAIRED AS NEEDED FOR THE DURATION OF THE JOB. THERE SHALL NOT BE MORE THAN 2 POSTS IN A 7' PATH FOR WOOD OR CHANNEL POSTS. ANY CHANNEL POST SPLICE SHALL BE IN ACCORDANCE WITH STANDARD DRAWING TC-3. 6. POST MOUNTED SIGNS IN RURAL AREAS SHALL BE CONSTRUCTED WITH THE NEAR EDGE OF THE SIGN FROM 6 TO 12 FEET FROM THE PAVEMENT EDGE. SIGNS IN URBAN AREAS AND BARRICADE MOUNTED SIGNS SHALL BE MOUNTED A MINIMUM OF 2 FEET FROM THE PAVEMENT EDGE. 7. ALL POST AND BARRICADE MOUNTED SIGNS MOUNTED IN URBAN AREAS SHALL BE MOUNTED A MINIMUM DISTANCE OF 7' FROM THE BOTTOM OF THE SIGN TO THE ROADWAY SURFACE. ALL POST AND BARRICADE MOUNTED SIGNS MOUNTED IN RURAL AREAS SHALL BE MOUNTED A MINIMUM DISTANCE OF 7' FROM THE BOTTOM OF THE SIGN TO THE ROADWAY SURFACE, EXCEPT A MINIMUM OF 6' SHALL BE USED WHEN MOUNTING AN ADVISORY SIGN BELOW A WARNING SIGN. TEMPORARY SIGNS MAY BE MOUNTED ON PORTABLE SUPPORTS FOR INTERMEDIATE TERM STATIONARY WORK CONDITIONS. THE SIGNS MINIMUM MOUNTING HEIGHT SHALL BE 5'. RETROREFLECTIVE DEVICES SHALL BE USED. TEMPORARY SIGNS MAY BE MOUNTED ON PORTABLE SUPPORTS FOR SHORT-TERM, SHORT DURATION, AND MOBILE CONDITIONS. THEY SHALL BE NO LESS THAN ONE (1) FOOT ABOVE THE TRAVELED WAY. LONG-TERM STATIONARY SIGNS SHALL BE DIRECT BURIED IN SOIL, UNLESS CONDITIONS NECESSITATE THE USE OF PORTABLE SIGNS, OR AS APPROVED BY THE ENGINEER. CONCRETE PADS, CONCRETE OR ROCK BALLAST, OR OTHER SOLID MATERIALS SHALL NOT BE UTILIZED WITH PORTABLE SIGN SUPPORTS. 8. FLAGGERS SHALL USE REFLECTORIZED STOP-SLOW PADDLES. FLAGS MAY BE USED ONLY FOR EMERGENCY SITUATIONS. 9. MOST OF THE SIGNS SHOWN ARE ORIENTED TO THE RIGHT. HOWEVER, THIS DOES NOT PRECLUDE THE USE OF MIRROR IMAGES OF THESE SIGNS WHERE THE REVERSE ORIENTATION MIGHT BETTER CONVEY TO MOTORISTS THE PROPER DIRECTION OF MOVEMENT. 10. R55-1 SIGNS SHALL BE PLACED AT LEAST 1500' BUT NOT MORE THAN 1 MILE IN ADVANCE OF THE WORK ZONE. IF A SPEED LIMIT REDUCTION IS IN EFFECT, THE SIGN SHALL BE PLACED A MINIMUM OF 500' IN ADVANCE OF THE "REDUCED SPEED AHEAD" SIGN.</p> <p>* NOTE: SUPPORTS FOR SIGNS, BARRICADES, AND VERTICAL PANELS THAT ARE DIFFERENT FROM THE REQUIREMENTS SHOWN IN NOTES 4 & 5, BUT MEET THE REQUIREMENTS OF MANUAL FOR ASSESSING SAFETY HARDWARE (MASH), WILL BE ACCEPTED. COMPLIANCE WITH THE REQUIREMENTS OF MANUAL FOR ASSESSING SAFETY HARDWARE (MASH) IS REQUIRED FOR ALL PROJECTS.</p>
<p>R5-1</p>  <p>STD. 30"x30" EXPWY. 36"x36" SPECIAL 48"x48"</p>	<p>R11-2</p>  <p>48"x30"</p>	<p>R11-3A</p>  <p>60"x30"</p>	<p>R11-4</p>  <p>60"x30"</p>	<p>W21-5a</p>  <p>STD. 36"x36" FWY. 48"x48"</p>	<p>W1-1</p>  <p>STD. 36"x36" FWY. 48"x48"</p>	<p>W1-2</p>  <p>STD. 36"x36" FWY. 48"x48"</p>	
<p>W1-3</p>  <p>STD. 48"x48"</p>	<p>W1-4</p>  <p>STD. 48"x48"</p>	<p>W1-6</p>  <p>STD. 48"x24" SPECIAL 60"x30"</p>	<p>W1-8</p>  <p>STD. 18"x24" SPECIAL 24"x30" EXPWY. 30"x36" FWY. 36"x48"</p>	<p>W3-1</p>  <p>STD. 36"x36" SPECIAL 48"x48"</p>	<p>W3-2</p>  <p>STD. 36"x36" SPECIAL 48"x48"</p>	<p>W4-2</p>  <p>STD. 36"x36" FWY. 48"x48"</p>	
<p>W5-1</p>  <p>STD. 36"x36" SPECIAL 48"x48"</p>	<p>W6-3</p>  <p>EXPWY. 36"x36" SPECIAL 48"x48"</p>	<p>W8-7</p>  <p>EXPWY. 36"x36" FWY. 48"x48"</p>	<p>W9-2</p>  <p>STD. 36"x36" FWY. 48"x48"</p>	<p>W13-1</p>  <p>STD. 24"x24"</p>	<p>W20-1</p>  <p>STD. 48"x48"</p>	<p>W20-2</p>  <p>STD. 48"x48"</p>	<p>W20-3</p>  <p>STD. 48"x48"</p>
<p>W20-4</p>  <p>STD. 48"x48"</p>	<p>W20-5</p>  <p>STD. 48"x48"</p>	<p>W20-7a</p>  <p>500 FEET 24" R56-2</p> <p>STD. 36"x36" FWY. 48"x48"</p>	<p>W21-2</p>  <p>STD. 30"x30" SPECIAL 36"x36"</p>	<p>W21-5</p>  <p>STD. 30"x30" SPECIAL 36"x36"</p>	<p>W24-1</p>  <p>STD. 36"x36"</p>	<p>W1-4b</p>  <p>STD. 48"x48"</p>	<p>R56-1</p>  <p>STD. 18"x18"</p>
<p>W8-11</p>  <p>STD. 36"x36" FWY. 48"x48"</p>	<p>W8-9</p>  <p>STD. 36"x36" FWY. 48"x48"</p>	<p>G20-1</p>  <p>60"x24"</p>	<p>G20-2</p>  <p>48"x24"</p>	<p>OM-3L OM-3R</p>  <p>12"x36"</p>	<p>M4-9</p>  <p>STD. 30"x24" SPECIAL 48"x36" SPECIAL 60"x48"</p>	<p>M4-10</p>  <p>48"x18"</p>	<p>R55-1</p>  <p>36"x60"</p> <p>• USE 6" C LETTERS •• USE 4" D LETTERS</p>

11-07-19	REVISED MASH		
4-13-17	DELETED RSP-1 & ADDED W21-5a		
9-2-15	REVISED REDUCED SPEED LIMIT AHEAD SIGNS		
	REVISED ROAD WORK NEXT XX MILES		
12-5-14	DELETED W24-1		
11-17-10	DELETED W8-9a & ADDED W8-9		
10-15-09	ADDED REFERENCE TO MASH & ADDED SIGN W24-1		
4-17-08	REVISED SIGN DESIGNATIONS		
11-8-04	REVISED NOTES		
10-9-03	REVISED NOTE 1		
11-6-01	REVISED NOTE 7		
9-28-00	REVISED NOTE		
11-8-98	ADDED NOTE		
6-26-97	REVISED NOTE 5		
4-03-97	REVISED NOTE 5		
10-8-96	ADDED CONTROLLED ACCESS HWY. SIGN & TO NOTE 7		
10-12-95	ADDED R55-1		
6-8-95	REVISED TO CORRECT SIGN ILLUSTRATIONS		6-8-95
2-2-95	REVISED PER PART VI, MUTCD SEPT. 3, 1993		
8-15-93	DRAWN AND PLACED IN USE		
DATE	REVISION		FILED

ARKANSAS STATE HIGHWAY COMMISSION
STANDARD TRAFFIC CONTROLS
FOR HIGHWAY CONSTRUCTION
STANDARD DRAWING TC-1

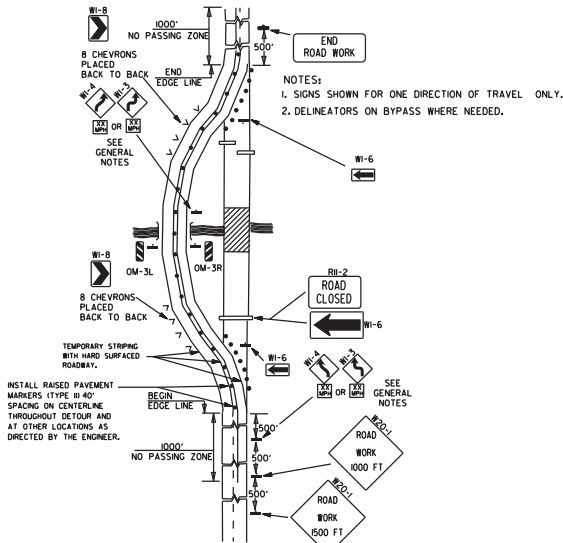

(A) TYPICAL APPLICATION OF TRAFFIC CONTROL DEVICES ON A 2-LANE HIGHWAY WHERE THE ENTIRE ROADWAY IS CLOSED AND A BYPASS DETOUR IS PROVIDED.

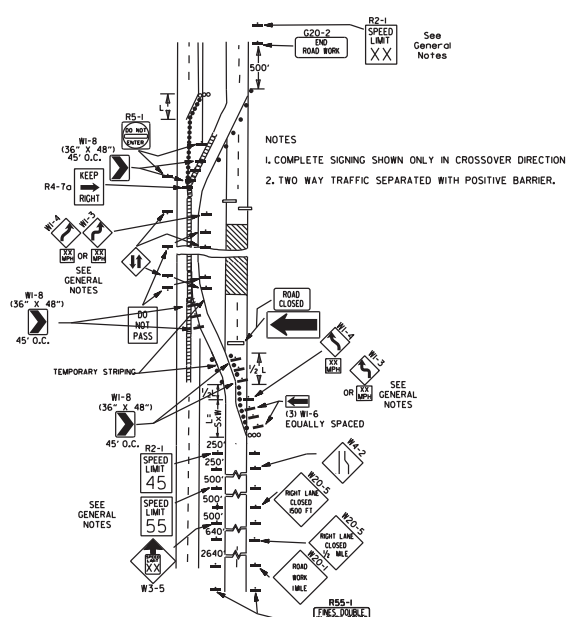

(B) TYPICAL APPLICATION - 4-LANE DIVIDED ROADWAY WHERE ONE ROADWAY IS CLOSED.

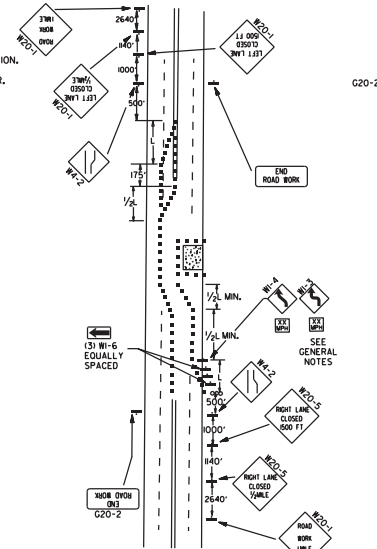

(C) TYPICAL APPLICATION - 4-LANE UNDIVIDED ROADWAY WHERE HALF OF THE ROADWAY IS CLOSED.

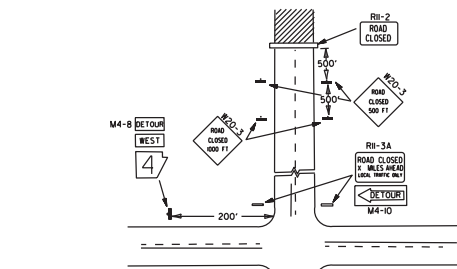

(D) TYPICAL APPLICATION - ROADWAY CLOSED BEYOND DETOUR POINT.

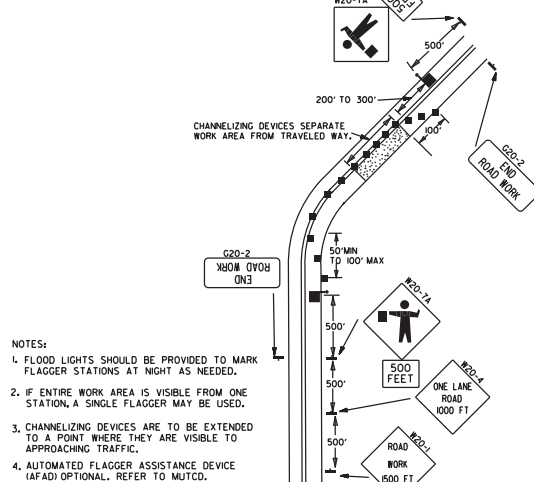

(E) TYPICAL APPLICATION OF TRAFFIC CONTROL DEVICES ON 2-LANE HIGHWAY WHERE ONE LANE IS CLOSED AND FLAGGING IS PROVIDED.

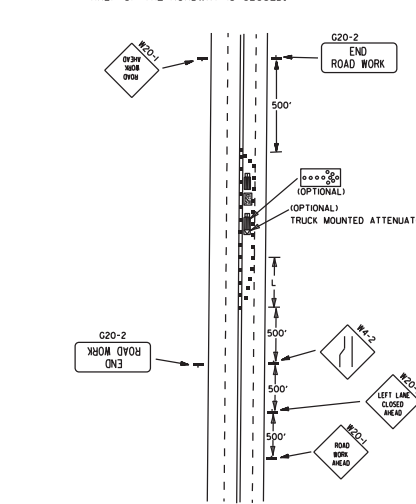

(F) TYPICAL APPLICATION - 4-LANE UNDIVIDED ROADWAY WITH INSIDE LANE CLOSED.

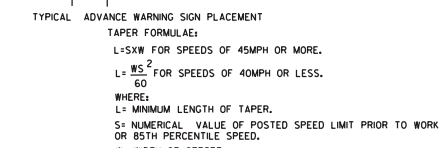
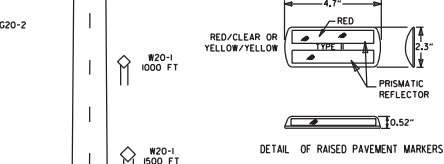
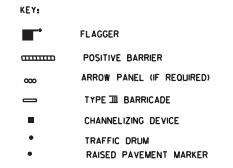

- GENERAL NOTES:
- THE MAINTENANCE DIVISION SHALL CONDUCT A BALL BANK STUDY TO DETERMINE THE ADVISORY SPEED LIMIT PRIOR TO OPENING TO TRAFFIC. THE ADVISORY SPEED LIMIT WILL BE POSTED ON W1-3 OR W1-4 CURVE WARNING SIGNS. USE W1-4 WHEN SPEED IS GREATER THAN 30MPH AND W1-3 WHEN 30MPH OR LESS.
 - WHEN THE EXISTING SPEED LIMIT IS 55MPH AND THE PLANS REQUIRE A SPEED LIMIT OF 45MPH, THE R2-145 SHALL BE OMITTED AND THE W3-5 SHALL BE INSTALLED AT THAT LOCATION. ADDITIONAL R2-145MPH SPEED LIMIT SIGNS SHALL BE INSTALLED AT A MAXIMUM OF 1/2 MILE INTERVALS. AT THE END OF THE WORK AREA A R2-145 SHALL BE INSTALLED TO MATCH ORIGINAL SPEED LIMIT.
 - WHEN THE EXISTING SPEED LIMIT IS 65MPH AND THE PLANS REQUIRE A SPEED LIMIT OF 55MPH, THE R2-145 SHALL BE OMITTED. ADDITIONAL R2-155MPH SPEED LIMIT SIGNS SHALL BE INSTALLED AT A MAXIMUM OF 1/2 MILE INTERVALS. AT THE END OF THE WORK AREA A R2-155 SHALL BE INSTALLED TO MATCH ORIGINAL SPEED LIMIT.
 - THE MAXIMUM SPACING BETWEEN CHANNELIZING DEVICES IN A TAPER SHOULD BE APPROXIMATELY EQUAL IN FEET TO THE SPEED LIMIT. BEYOND THE TAPER, MAXIMUM SPACING SHALL BE TWO TIMES THE SPEED LIMIT OR AS DIRECTED BY THE ENGINEER.
 - WARNING LIGHTS AND/OR FLAGS MAY BE MOUNTED TO SIGNS OR CHANNELIZING DEVICES AT NIGHT AS NEEDED.
 - PAVEMENT MARKINGS NO LONGER APPLICABLE WHICH MIGHT CREATE CONFUSION IN THE MINDS OF VEHICLE OPERATORS SHALL BE REMOVED OR OBLITERATED AS SOON AS PRACTICABLE.
 - TRAILER MOUNTED DEVICES SUCH AS ARROW PANELS AND PORTABLE CHANGEABLE MESSAGE SIGNS SHALL BE DELINEATED BY AFFIXING CONSPICUOUS MATERIAL IN A CONTINUOUS LINE ON THE FACE OF THE TRAILER. WHEN PLACED ON OR ADJACENT TO THE SHOULDER AND NOT BEHIND A POSITIVE BARRIER, THESE DEVICES SHALL BE DELINEATED BY PLACING FIVE (5) TRAFFIC DRUMS, EQUALLY SPACED ALONG THE TRAFFIC SIDE OF THE DEVICE. PAYMENT FOR TRAFFIC DRUMS SHALL BE CONSIDERED INCLUDED IN THE PRICE BID FOR VARIOUS TRAILER MOUNTED DEVICES.
 - DIMENSIONS SHOWN FOR RAISED PAVEMENT MARKERS ARE TYPICAL. THE CONTRACTOR MAY SUBSTITUTE SIMILAR MARKERS WITH THE APPROVAL OF THE ENGINEER. REQUESTING APPROVAL FOR SIMILAR MARKERS MAY BE MADE BY REFERRING TO THE AASHTO QUALIFIED PRODUCTS LIST.
 - ALL TRAILER MOUNTED DEVICES SUCH AS ARROW PANELS AND PORTABLE CHANGEABLE MESSAGE SIGNS SHALL MEET THE REQUIREMENTS OF THE MANUAL FOR ASSESSING SAFETY HARDWARE (MASH).

DATE	REVISION	FILED
05-20-21	REVISED NOTE 7	
11-07-19	REVISED NOTE 1, ADDED NOTE 9	
9-2-15	REVISED NOTE 2, ADDED NOTE 8, REVISED DRAWING (A) & REPLACED R2-5A WITH W3-5	
9-12-13	REVISED DETAIL OF RAISED PAVEMENT MARKERS	
3-1-10	ADDED (AFAD)	
11-20-08	REVISED SIGN DESIGNATIONS	
11-18-04	ADDED GENERAL NOTE	
10-18-96	ADDED R55-1	
4-28-96	CORRECTED 100 BEHIND G20-2	
6-8-95	CORRECTED SIGN IDENT. ON W1-4A	6-8-95
2-2-95	REVISED PER PART V, MUTCD, SEPT. 3, 1993	
8-15-91	DRAWN AND PLACED IN USE	

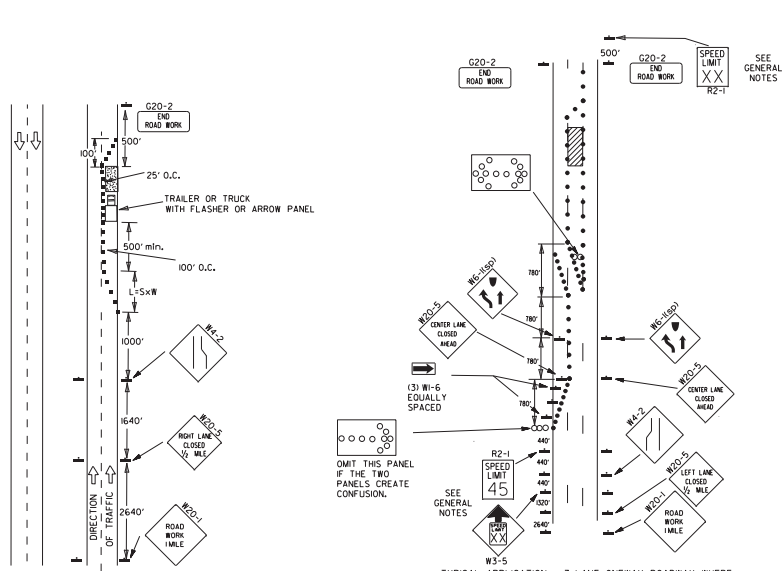

(A) TYPICAL APPLICATION - DAYTIME MAINTENANCE OPERATIONS OF SHORT DURATION ON A 4-LANE DIVIDED ROADWAY WHERE HALF OF THE ROADWAY IS CLOSED.

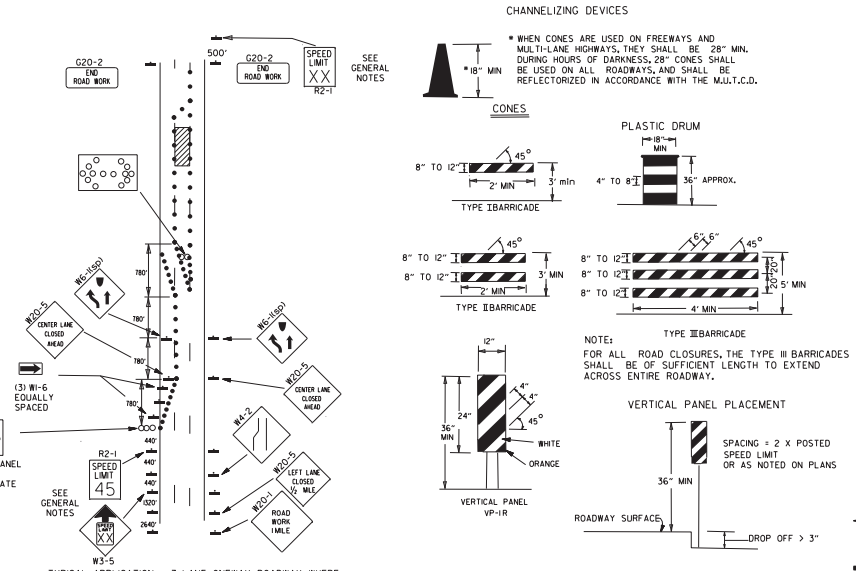

(B) TYPICAL APPLICATION - 3-LANE ONEWAY ROADWAY WHERE CENTER LANE IS CLOSED.

- KEY:
- ○ ○ ○ ARROW PANEL (IF REQUIRED)
 - CHANNELIZING DEVICE
 - TRAFFIC DRUM
- GENERAL NOTES:

1. A SPEED LIMIT REDUCTION MAY BE IMPLEMENTED ONLY WHEN DESIGNATED IN THE PLAN OR WHEN RECOMMENDED BY THE ROADWAY DESIGN DIVISION.
2. WHEN THE EXISTING SPEED LIMIT IS 55MPH AND THE PLANS REQUIRE A SPEED LIMIT OF 45MPH, THE R2-1(45) SHALL BE OMITTED AND THE W3-5 SHALL BE INSTALLED AT THAT LOCATION. ADDITIONAL R2-1(45)MPH SPEED LIMIT SIGNS SHALL BE INSTALLED AT A MAXIMUM OF 1/4 MILE INTERVALS. AT THE END OF THE WORK AREA A R2-1(45)MPH SHALL BE INSTALLED TO MATCH ORIGINAL SPEED LIMIT.
3. WHEN THE EXISTING SPEED LIMIT IS 65MPH AND THE PLANS REQUIRE A SPEED LIMIT OF 55MPH, THE R2-1(55) SHALL BE OMITTED. ADDITIONAL R2-1(55)MPH SPEED LIMIT SIGNS SHALL BE INSTALLED AT A MAXIMUM OF 1/4 MILE INTERVALS. AT THE END OF THE WORK AREA A R2-1(55)MPH SHALL BE INSTALLED TO MATCH ORIGINAL SPEED LIMIT.
4. THE MAXIMUM SPACING BETWEEN CHANNELIZING DEVICES IN A TAPER SHOULD BE APPROXIMATELY EQUAL IN FEET TO THE SPEED LIMIT. BEYOND THE TAPER, MAXIMUM SPACING SHALL BE TWO TIMES THE SPEED LIMIT OR AS DIRECTED BY THE ENGINEER.
5. WARNING LIGHTS AND/OR FLAGS MAY BE MOUNTED TO SIGNS OR CHANNELIZING DEVICES AT NIGHT AS NEEDED.
6. PAYMENT MARKINGS NO LONGER APPLICABLE WHICH MIGHT CREATE CONFUSION IN THE MINDS OF VEHICLE OPERATORS SHALL BE REMOVED OR OBLITERATED AS SOON AS PRACTICABLE.
7. THE G20-1 SIGN WILL BE REQUIRED ON JOBS OF OVER TWO MILES IN LENGTH. WHEN THE LANE CLOSURE IS NOT AT THE BEGINNING OF THE PROJECT, THE G20-1 SIGN SHALL BE ERRECTED 125' IN ADVANCE OF THE JOB LIMIT. ADDITIONAL W20-1(MILE) SIGNS ARE NOT REQUIRED IN ADVANCE OF LANE CLOSURES THAT BEGON INSIDE THE PROJECT LIMITS.
8. FLAGGERS SHALL USE STOP/SLOW PADDLES FOR CONTROLLING TRAFFIC THROUGH WORK ZONES. FLAGS MAY BE USED ONLY FOR EMERGENCY SITUATIONS.
9. ALL PLASTIC DRUMS AND CONES SHALL MEET THE REQUIREMENTS OF MANUAL FOR ASSESSING SAFETY HARDWARE (MASH).
10. ALL TRAILER MOUNTED DEVICES SUCH AS ARROW PANELS AND PORTABLE CHANGEABLE MESSAGE SIGNS SHALL BE DELINEATED BY AFFIXING CONSPICUITY MATERIAL IN A CONTINUOUS LINE ON THE FACE OF THE TRAILER, WHEN PLACED ON OR ADJACENT TO THE SHOULDER AND NOT BEHIND A POSITIVE BARRIER, THESE DEVICES SHALL BE DELINEATED BY PLACING FIVE (5) TRAFFIC DRUMS, EQUALLY SPACED ALONG THE TRAFFIC SIDE OF THE DEVICE. PAYMENT FOR TRAFFIC DRUMS SHALL BE CONSIDERED INCLUDED IN THE PRICE BID FOR VARIOUS TRAILER MOUNTED DEVICES.
11. ALL TRAILER MOUNTED DEVICES SUCH AS ARROW PANELS AND PORTABLE CHANGEABLE MESSAGE SIGNS SHALL MEET THE REQUIREMENTS OF THE MANUAL FOR ASSESSING SAFETY HARDWARE (MASH).

(C) TYPICAL APPLICATION - CONSTRUCTION OPERATIONS OF INTERMEDIATE TO LONG TERM DURATION ON A 4-LANE DIVIDED ROADWAY WHERE HALF OF THE ROADWAY IS CLOSED.

CHANNELIZING DEVICES

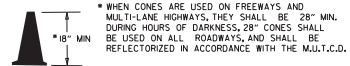

PLASTIC DRUM

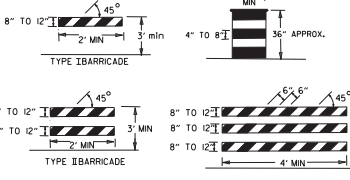

NOTE: FOR ALL ROAD CLOSURES, THE TYPE III BARRICADES SHALL BE OF SUFFICIENT LENGTH TO EXTEND ACROSS ENTIRE ROADWAY.

VERTICAL PANEL PLACEMENT

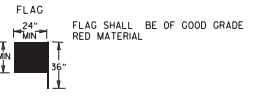
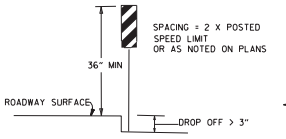

FLAG SHALL BE OF GOOD GRADE RED MATERIAL

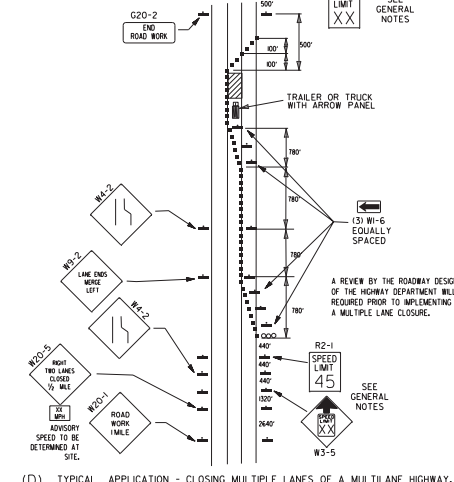

(D) TYPICAL APPLICATION - CLOSING MULTIPLE LANES OF A MULTILANE HIGHWAY.

TRAFFIC CONTROL DEVICES

VERTICAL DIFFERENTIAL	LOCATION	NON-INTERSTATE	
		≤ 45MPH	> 45MPH
≤ 1"	CENTERLINE	W5-11	W8-11
> 1"	CENTERLINE	W8-11 AND CENTERLINE LANE STRIPING	W8-11 AND CENTERLINE LANE STRIPING
≤ 3"	CENTERLINE	STANDARD LANE CLOSURE ⁽¹⁾	STANDARD LANE CLOSURE ⁽¹⁾
≤ 3"	EDGE OF TRAVELED LANE OR EDGE OF SHOULDER	W8-9 AND TRAFFIC DRUMS ⁽¹⁾	W8-9 AND TRAFFIC DRUMS ⁽¹⁾
> 3"	EDGE OF TRAVELED LANE OR EDGE OF SHOULDER	W8-17, EDGE LINE STRIPING, AND TRAFFIC DRUMS ⁽¹⁾	W8-17, EDGE LINE STRIPING, AND TRAFFIC DRUMS ⁽¹⁾
> 6"	EDGE OF TRAVELED LANE OR EDGE OF SHOULDER	W8-17, EDGE LINE STRIPING, AND TRAFFIC DRUMS ⁽¹⁾	W8-17, EDGE LINE STRIPING, AND TRAFFIC DRUMS ⁽¹⁾
> 18"	EDGE OF TRAVELED LANE OR EDGE OF SHOULDER	W8-17, EDGE LINE STRIPING, AND TRAFFIC DRUMS ⁽¹⁾	A STABILIZED WEDGE, W8-17, EDGE LINE STRIPING AND TRAFFIC DRUMS ⁽¹⁾
> 24"	EDGE OF TRAVELED LANE OR EDGE OF SHOULDER	PRECAST CONCRETE BARRIER ⁽¹⁾ & EDGE LINES	PRECAST CONCRETE BARRIER ⁽¹⁾ & EDGE LINES

VERTICAL DIFFERENTIAL	LOCATION	INTERSTATE	
		≤ 45MPH	> 45MPH
≤ 3"	CENTERLINE	W8-11 AND LANE STRIPING	W8-11 AND LANE STRIPING
≤ 3"	EDGE OF TRAVELED LANE OR EDGE OF SHOULDER	W8-9, EDGE LINE STRIPING, AND TRAFFIC DRUMS ⁽¹⁾	W8-9, EDGE LINE STRIPING, AND TRAFFIC DRUMS ⁽¹⁾
> 3"	EDGE OF TRAVELED LANE OR EDGE OF SHOULDER	W8-17, EDGE LINE STRIPING, AND TRAFFIC DRUMS ⁽¹⁾	W8-17, EDGE LINE STRIPING, AND TRAFFIC DRUMS ⁽¹⁾
> 6"	EDGE OF TRAVELED LANE OR EDGE OF SHOULDER	PRECAST CONCRETE BARRIER & EDGE LINES	PRECAST CONCRETE BARRIER & EDGE LINES

FORESLOPE	HEIGHT	INTERSTATE AND NON-INTERSTATE	
		≤ 45MPH	> 45MPH
1:1	> 2 FT	PRECAST CONCRETE BARRIER	PRECAST CONCRETE BARRIER
2:1	≤ 5 FT	TRAFFIC DRUMS	TRAFFIC DRUMS
2:1	> 5 FT	PRECAST CONCRETE BARRIER	PRECAST CONCRETE BARRIER
Flatter than 2:1	N/A	TRAFFIC DRUMS	TRAFFIC DRUMS

- GENERAL NOTES:
1. WHEN THE SHOULDER AREA IS USED AS PART OF THE TRAVELED LANE AND THERE IS INSUFFICIENT WIDTH TO PLACE TRAFFIC DRUMS ON THE REMAINING SHOULDER WIDTH, THEN VERTICAL PANELS SHALL BE USED.
 2. WHEN THERE IS INSUFFICIENT WIDTH TO PLACE TRAFFIC DRUMS ON THE REMAINING SHOULDER WIDTH, A STABILIZED WEDGE SHALL BE USED.
 3. PRECAST CONCRETE BARRIER WALL CAN BE USED IN LIEU OF A STABILIZED WEDGE, W8-17, EDGE LINE STRIPING, AND TRAFFIC DRUMS, IF AND WHERE DIRECTED BY THE ENGINEER.
 4. A STABILIZED WEDGE, W8-17, SIGN, EDGE LINE STRIPING, AND TRAFFIC DRUMS, CAN BE USED IN LIEU OF PRECAST CONCRETE BARRIER WALL, IF AND WHERE DIRECTED BY THE ENGINEER.
 5. W2-5, W2-5a, AND/OR W2-5b SIGNS SHALL BE USED WHERE THE ROADWAY IS UNOBSTRUCTED IF AND WHERE DIRECTED BY THE ENGINEER.
 6. TIME LIMITATIONS MUST CONFORM TO SECTION 603 OF THE STANDARD SPECIFICATIONS FOR HIGHWAY CONSTRUCTION (CURRENT EDITION).

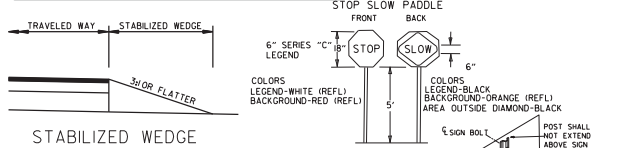

STABILIZED WEDGE

NOTE: MATERIALS FOR THE STABILIZED WEDGE SHALL MEET THE REQUIREMENTS PROVIDED IN SECTION 603.02 OF THE STANDARD SPECIFICATIONS.

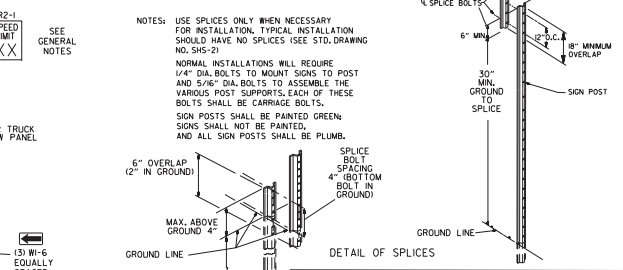

DATE	REVISION	FILED
08-12-21	REVISED TRAFFIC CONTROL DEVICES AND NOTES	
05-20-20	REVISED NOTE 10	
2-21-20	REVISED TRAFFIC CONTROL DEVICES DETAILS	
11-07-19	REVISED NOTE 9, ADDED NOTE #	
7-25-19	REVISED TRAFFIC CONTROL DEVICES DETAILS	
9-2-15	REVISED NOTE 2 & REPLACED R2-5a WITH W3-5	
10-05-15	ADDED REFERENCE TO MASH	
4-20-08	REVISED SIGN DESIGNATIONS	
11-8-04	ADDED NOTE	
10-1-98	ADDED NOTE	
4-03-97	ADDED ISP1 TO W6-18 REVISED TRAFFIC CONTROL DEVICES NOTE	
10-18-96	ADDED R55-1	
10-12-95	MOVED UPPER SPLICE	
6-8-95	REVISED SPLICE DETAIL, TEXT	6-8-95
2-2-95	REVISED PER PART VI, MUTCO, SEPT. 3, 1993	
8-25-91	DRAWN AND PLACED IN USE	

**ARKANSAS
STATE HIGHWAY COMMISSION**



**STANDARD SPECIFICATIONS
FOR
HIGHWAY CONSTRUCTION**

EDITION OF 2014

***PROPOSAL DOCUMENTS
AND
SCHEDULE OF ITEMS***

ARKANSAS STATE HIGHWAY COMMISSION

PROPOSAL DOCUMENTS

PROPOSAL FOR CONSTRUCTING:

THE PURPOSE OF THIS PROJECT IS TO MILL AND OVERLAY APPROXIMATELY 18.227 MILES OF HIGHWAY 10 IN PERRY COUNTY. THIS PROJECT CONSISTS OF REMOVAL AND DISPOSAL OF GUARDRAIL, AGGREGATE BASE AND SURFACE COURSES, ACHM SURFACE COURSE, COLD MILLING ASPHALT PAVEMENT, ACHM PATCHING OF EXISTING ROADWAY, MAINTENANCE OF TRAFFIC, GUARDRAIL, RUMBLE STRIPES, PAVEMENT MARKING, AND MISC. ITEMS.

State Highway 10, Section 5, in **PERRY** County, Arkansas, in accordance with Standard Specifications for Highway Construction, Edition of 2014; the Supplemental Specifications and Special Provisions attached hereto; and the Construction Plans on file in the Office of the State Highway Commission, designated as

Job **A80035** **FEDERAL AID PROJECT STPR-0053(40)**

Job Name: **YELL CO. LINE – PERRY (S)**

said project being approximately **18.227 miles in length.**

Proposal received until 1:30 p.m. on May 22, 2024

TO THE ARKANSAS STATE HIGHWAY COMMISSION:

Gentlemen: By submission of your bid, you agree to the following:

It is hereby certified that a careful examination has been made of the Plans, Specifications, Supplemental Specifications, Special Provisions, and Form of Contract and the site of the work throughout its whole extent. On the basis of the Plans, Specifications, Supplemental Specifications, Special Provisions, and Form of Contract, the bidder proposes to furnish all necessary machinery, equipment, tools, labor and other means of construction, and to furnish all materials as specified, in the manner and at the time prescribed, and to finish the entire project within the time hereinafter proposed. The bidder understands that the quantities of work mentioned herein are approximate only, and are subject to increase or decrease, and hereby proposes to perform all quantities of work, whether increased or decreased, in accordance with the provisions of the Specifications, and at the unit prices bid in the attached Schedule of Items.

Receipt is hereby specifically acknowledged, and complete examination expressly guaranteed of the following:

1. Standard Specifications for Highway Construction, Edition of 2014.
2. Supplemental Specifications.
3. Special Provisions.
4. Proposal Documents.
5. Schedule of Items .
6. Construction Plans.

The bidder further proposes to perform all Extra Work that may be required, on the basis provided in the Specifications, and to give such work personal attention, and to secure economical performance.

The bidder further proposes to execute the contract agreement, and to furnish satisfactory bonds within ten days after he has received notice that he has been awarded the contract. The bidder further agrees to begin work when ordered by the Engineer, or within ten days thereafter, and to complete the work **on or before December 13, 2024.**

PROPOSAL DOCUMENTS

(Continued)

The bidder also proposes to furnish a surety Performance bond or bonds in a sum equal to the full amount of the contract and a surety Payment bond or bonds in a sum equal to 80% of the full amount of the contract. These bonds shall not only serve to guarantee the completion of the work and payment of all bills and claims by the bidder, but also to guarantee the excellence of both workmanship and material until the work is finally accepted and the provisions of the Plans, Specifications and Special Provisions fulfilled.

The bidder shall furnish a Proposal Guaranty in the form specified in Subsection 102.09 of the Specifications, in the amount of five percent (5%) of the total amount bid, which is submitted as a guarantee of the good faith of the proposal, and that the Bidder will enter into written contract, as provided, to do the work should the award be made to him; and it is hereby agreed that if, at any time other than as provided in Subsection 102.11 of the Standard Specifications, Withdrawal/Modification of Proposals, the bidder should withdraw his proposal, or should fail to execute the contract and furnish satisfactory bonds as herein provided, if his proposal is accepted, the Arkansas State Highway Commission, in either of such events, shall be entitled and is hereby given the right to retain the Proposal Guaranty, not as a penalty, but as liquidated damages, it being understood and agreed by the bidder that the amount of the Proposal Guaranty is a reasonable sum to be fixed as liquidated damages considering the damages the Arkansas State Highway Commission will sustain in the event of the bidder's withdrawal of his proposal, or failure to execute the contract and furnish satisfactory bonds if his proposal is accepted, and said amount is herein agreed upon and fixed as liquidated damages because of the difficulty of ascertaining the exact amount of damage that may be sustained by reason of the above set out circumstances.

Arkansas Department of Transportation
Schedule of Items

State Job No.: A80035
Job Name: YELL CO. LINE – PERRY (S)
Federal Aid Project: STPR-0053(40)

Date Estimated: 3/18/2024
Date Revised:

Line Number	Item Code and Description	Estimated Quantity	Unit Bid Price	Price Extension
Section 01 - PROPOSAL ITEMS				
0001	202 - REMOVAL AND DISPOSAL OF GUARDRAIL	520.000 LF		
0002	SPSS303 - AGGREGATE BASE COURSE (CLASS 7)	50.000 TON		
0003	SP&303 - AGGREGATE SURFACE COURSE (CLASS D-8)	555.000 TON		
0004	SS&401 - TACK COAT	59,324.000 GAL		
0005	SPSS407 - MINERAL AGGREGATE IN ACHM SURFACE COURSE (1/2")	35,451.000 TON		
0006	SPSS407 - ASPHALT BINDER (PG 70-22) IN ACHM SURFACE COURSE (1/2") (MINIMUM BID \$120.00)	2,343.000 TON		
0007	SP&412 - COLD MILLING ASPHALT PAVEMENT	343,579.000 SQYD		
0008	SPSS414 - ASPHALT CONCRETE PATCHING FOR MAINTENANCE OF TRAFFIC	458.000 TON		
0009	SPSS415 - ACHM PATCHING OF EXISTING ROADWAY	740.000 TON		
0010	SS&603 - MAINTENANCE OF TRAFFIC	1.000 L.S.		
0011	SS&604 - SIGNS	1,882.000 SQFT		
0012	604 - CONSTRUCTION PAVEMENT MARKINGS	649,712.000 LF		
0013	SS&617 - GUARDRAIL (TYPE A)	425.000 LF		
0014	SS&617 - GUARDRAIL TERMINAL (TYPE 2)	5.000 EACH		
0015	SS&617 - THRIE BEAM GUARDRAIL TERMINAL	5.000 EACH		
0016	SP&642 - RUMBLE STRIPES IN ASPHALT SHOULDERS	68,038.000 LF		
0017	SP&642 - CENTERLINE RUMBLE STRIPES IN ASPHALT ROADWAYS	85,047.000 LF		
0018	719 - THERMOPLASTIC PAVEMENT MARKING WHITE (6")	192,814.000 LF		
0019	719 - THERMOPLASTIC PAVEMENT MARKING WHITE (12")	36.000 LF		
0020	719 - THERMOPLASTIC PAVEMENT MARKING YELLOW (6")	132,042.000 LF		
0021	719 - THERMOPLASTIC PAVEMENT MARKING (WORDS)	1.000 EACH		

Arkansas Department of Transportation
Schedule of Items

State Job No.: A80035
 Job Name: YELL CO. LINE – PERRY (S)
 Federal Aid Project: STPR-0053(40)

Date Estimated: 3/18/2024
 Date Revised:

Line Number	Item Code and Description	Estimated Quantity	Unit Bid Price	Price Extension
0022	719 - THERMOPLASTIC PAVEMENT MARKING (ARROWS)	1.000 EACH	_____	_____
0023	721 - RAISED PAVEMENT MARKERS (TYPE II)	1,212.000 EACH	_____	_____
Section 01 Total:				_____
Subtotal:				_____
0024	601 - MOBILIZATION (UNIT BID AMOUNT MAY NOT EXCEED 5% OF SUBTOTAL)	1.000 L.S.	_____	_____
Bid Total:				_____

ARKANSAS DEPARTMENT OF TRANSPORTATION
SUPPLEMENT TO PROPOSAL
ANTI-COLLUSION AND DEBARMENT CERTIFICATION

**FAILURE TO EXECUTE AND SUBMIT THIS CERTIFICATION SHALL RENDER THIS
BID NONRESPONSIVE AND NOT ELIGIBLE FOR AWARD CONSIDERATION.**

As a condition precedent to the acceptance of the bidding document for this project, the bidder shall file this Affidavit executed by, or on behalf of the person, firm, association, or corporation submitting the bid. The original of this Affidavit shall be filed with the Arkansas Department of Transportation **at the time proposals are submitted.**

A F F I D A V I T

I hereby certify, under penalty of perjury under the laws of the United States and/or the State of Arkansas, that the bidder listed below has not, either directly or indirectly, entered into any agreement, participated in any collusion, or otherwise taken any action in restraint of free competitive bidding in connection with the submitted bid for this project, is not presently barred from bidding in any other jurisdiction as a result of any collusion or any other action in restraint of free competition, and that the foregoing is true and correct.

Further, that except as noted below, the bidder, or any person associated therewith in the capacity of owner, partner, director, officer, principal investigator, project director, manager, auditor, or any position involving the administration of Federal funds:

- a. is not currently under suspension, debarment, voluntary exclusion, or determination of ineligibility by any Federal, State, or Local agency;
- b. has not been suspended, debarred, voluntarily excluded or determined ineligible by any Federal, State, or Local agency within the past 3 years;
- c. does not have a proposed debarment pending; and
- d. has not been indicted, convicted, or had an adverse civil judgment rendered by a court of competent jurisdiction in any matter involving fraud or official misconduct within the past 3 years.

**ARKANSAS DEPARTMENT OF TRANSPORTATION
SUPPLEMENT TO PROPOSAL
ANTI-COLLUSION AND DEBARMENT CERTIFICATION**

**FAILURE TO EXECUTE AND SUBMIT THIS CERTIFICATION SHALL RENDER THIS
BID NONRESPONSIVE AND NOT ELIGIBLE FOR AWARD CONSIDERATION.**

EXCEPTIONS:

APPLIED TO	INITIATING AGENCY	DATES OF ACTION
_____	_____	_____
_____	_____	_____
_____	_____	_____

Exceptions will not necessarily result in denial of award, but will be considered in determining bidder responsibility. Providing false information may result in criminal prosecution or administrative sanctions.

Job No. _____ _____ F.A.P. No. _____ _____ _____ (Date Executed)	_____ (Name of Bidder) _____ (Signature) _____ (Title of Person Signing)
---	---

The following Notary Public certification is **OPTIONAL** and may or may not be completed at the contractor's discretion.

State of _____)
County of _____)ss.

_____, being duly sworn, deposes and says that he is

_____ of _____
(Title) (Name of Bidder)

and that the above statements are true and correct.

Subscribed and Sworn to before me this _____ day of _____, 20____.
My commission expires: _____.

(Notary Public)

ARKANSAS DEPARTMENT OF TRANSPORTATION
SUPPLEMENT TO PROPOSAL
RESTRICTION OF BOYCOTT OF ISRAEL CERTIFICATION

Pursuant to Arkansas Code Annotated § 25-1-503, a public entity **shall not** enter into a contract valued at \$1,000 or greater with a company unless the contract includes a written certification that the person or company is not currently engaged in, and agrees for the duration of the contract not to engage in, a boycott of Israel.

By signing below, the Contractor agrees and certifies that they do not boycott Israel and will not boycott Israel during the remaining aggregate term of the contract.

If a company does boycott Israel, see Arkansas Code Annotated § 25-1-503.

Bid Number/Contract Number	
Description of product or service	
Contractor name	

Contractor Signature: _____

Date: _____

ARKANSAS DEPARTMENT OF TRANSPORTATION
SUPPLEMENT TO PROPOSAL
CERTIFICATION FOR FEDERAL-AID CONTRACTS

The prospective contractor certifies, by signing and submitting this proposal, to the best of his or her knowledge and belief that:

1. No Federal appropriated funds have been paid or will be paid, by or on his or her behalf, to any person for influencing or attempting to influence an officer or employee of any Federal agency, a member of Congress, an officer or employee of Congress, or any employee of a member of Congress in connection with the awarding of any Federal contract, the making of any Federal grant, the making of any Federal loan, the entering into of any cooperative agreement, and the extension, continuation, renewal, amendment, or modification of any Federal contract, grant, loan, or cooperative agreement.
2. If any funds other than Federal appropriated funds have been paid or will be paid to any person for influencing or attempting to influence an officer or employee of any Federal agency, a member of Congress, an officer or employee of Congress, or an employee of a member of Congress in connection with this Federal-Aid contract, the prospective contractor shall complete and submit Standard Form-LLL, "Disclosure of Lobbying Activities", in accordance with its instructions. (Available from Arkansas Department of Transportation, Program Management Division.)

This Certification is a material representation of fact upon which reliance was placed when this transaction was made or entered into. This Certification is a prerequisite for making or entering into this transaction imposed by Section 1352, Title 31, U.S. Code.

During the period of performance of the contract, the contractor and all lower tier subcontractors must file a Form-LLL at the end of each calendar year quarter in which there occurs any event that requires disclosure or that materially affects the accuracy of the information contained in any previously filed disclosure form. Any person who fails to file the required Certification shall be subject to a civil penalty of not less than \$10,000 and not more than \$100,000 for each failure.

The prospective contractor also agrees by submitting his or her proposal that he or she shall require that the language of this Certification be included in all lower tier subcontracts which exceed \$100,000 and that all such subcontractors shall certify and disclose accordingly.

ARKANSAS DEPARTMENT OF TRANSPORTATION
SUPPLEMENT TO PROPOSAL
C E R T I F I C A T I O N

THIS CERTIFICATION SHALL BE COMPLETED BY THE BIDDER
AS PART OF THIS PROPOSAL

The bidder _____, proposed subcontractor _____, hereby certifies that he has _____, has not _____, participated in a previous contract or subcontract subject to the equal opportunity clause, as required by Executive Orders 10925, 11114, or 11246, and that he has _____, has not _____, filed with the Joint Reporting Committee, the Director of the Office of Federal Contract Compliance, a Federal Government contracting or administering agency, or the former President's Committee on Equal Employment Opportunity, all reports due under the applicable filing requirements.

(Currently, Standard Form 100 [EEO-1] is the only report required by the Executive Orders or their implementing regulations)

Job No. _____ (Company)

F.A.P. No. _____ By: _____

Date _____ (Title)

NOTE: The above certification is required by the Equal Employment Opportunity Regulations of the Secretary of Labor (41 CFR 60-1.7(b)(1)), and must be submitted by bidders and proposed subcontractors only in connection with contracts and subcontracts which are subject to the equal opportunity clause. Contracts and subcontracts which are exempt from the equal opportunity clause are set forth in 41 CFR 60-1.5. (Generally only contracts or subcontracts of \$10,000 or under are exempt.)

Proposed prime contractors and subcontractors who have participated in a previous contract or subcontract subject to the Executive Orders and have not filed the required reports should note that 41 CFR 60-1.7(b)(1) prevents the award of contracts and subcontracts unless such contractor submits a report covering the delinquent period or such other period specified by the Federal Highway Administration or by the Director, Office of Federal Contract Compliance, U.S. Department of Labor.

ARKANSAS DEPARTMENT OF TRANSPORTATION

CERTIFICATION TO SUBMIT DBE PARTICIPATION

JOB A80035

**FAILURE TO COMPLY WITH ONE OF THE FOLLOWING SHALL RENDER THIS BID
NONRESPONSIVE AND NOT ELIGIBLE FOR AWARD CONSIDERATION**

- (1) SUBMITTAL OF REQUIRED DBE PARTICIPATION INFORMATION,**
- (2) SUBMITTAL OF DOCUMENTATION OF GOOD FAITH EFFORTS, OR**
- (3) SUBMITTAL OF THE CERTIFICATION TO SUBMIT DBE PARTICIPATION**

By submitting an internet proposal, the bidder irrevocably certifies that an amount equal to or greater than the Disadvantaged Business Enterprise (DBE) Goal established for this project will be performed by certified Disadvantaged Business Enterprise firms and the required DBE participation information will be submitted within 5 calendar days of the date of the bid opening.

Within five (5) calendar days of the date of the bid letting, all bidders shall furnish the required DBE Participation information to the Department on the forms provided to be considered a responsive bid. If a conditional award has been made and the successful bidder has not furnished the required information, the proposal will be rejected and their proposal guaranty forfeited. The proposal guaranty shall become property of the Commission, not as a penalty, but in liquidation of damages, sustained to the DBE Program. Award may then be made to the next lowest, responsive bidder or the work may be re-advertised as the Commission may decide.

Only work, materials, or services that will actually be provided by DBE firms will be credited toward the goal. The DBE firm's certification must be fully in effect at the letting date.

As an alternative, documentation of Good Faith Efforts to meet the DBE goal may be submitted to the Program Management Division prior to the deadline for proposals to be received.

