

**ARKANSAS
STATE HIGHWAY
COMMISSION
PROPOSAL DOCUMENTS**

FOR THE CONSTRUCTION OF

STATE JOB NO. SA1066

STATE AID COUNTY JOB (CODE 9970)

CO. RD. 36 OVERLAY (S)

COUNTY ROAD NO. CR 36

IN CLARK COUNTY

Bound herein are the Supplemental Specifications, Special Provisions, Proposal Documents and Schedule of Items applicable to this proposed construction contract.

Applicable to this proposed construction contract, but not bound herein, are the Arkansas State Highway Commission Standard Specifications for Highway Construction, Edition of 2014, and the Construction Plans.



CAUTION TO BIDDERS

Please review Section 102 of the Standard Specifications, 2014 Edition for Bidding Requirements and Conditions. Mistakes or omissions can be costly. Important items for you to check are included in, but not limited to, those listed below. This checklist is furnished only to assist you in submitting a proper bid. Check as you read.

- Have you contacted ARDOT (pmd@ardot.gov or 501-569-2261) to become an eligible bidder? This is required to submit a bid in the letting and must occur by 4:30pm the day prior to the letting.
- Have you acknowledged all Addenda by email or fax?
- Is the unit price entered appropriate for the item?
- Have you entered a unit price for each bid item except in the case of authorized alternate pay items? (A zero bid (\$0.00) is a valid price and will be considered.)
- Have you checked the Schedule of Items for various pay items that may have a minimum or maximum unit bid price? (Refer to the Standard Specifications for further information concerning these items)
 - ✓ Asphalt Binder
 - ✓ Relocating Precast Concrete Barrier
 - ✓ Water
 - ✓ Mobilization
- Have you limited your bid for Mobilization to five percent (5%) of the subtotal?
- For Federal-aid projects, did you complete the Certification for Federal aid Contracts?
- Prior to submitting your bid, did you check for error messages, and are all the folders "green"?
- If submitting a paper copy of the Proposal Guaranty (Bid Bond) is it signed by an officer of your company **AND** the Surety Agent?
- Did you ensure your Proposal Guaranty (if you are submitting a paper bond) will arrive prior to the time and date stated on Page 2 of the Proposal Documents?

1-17-08
Revised: 6-1-09
Revised: 2-15-12
Revised: 1-15-15
Revised: 5-26-16
Revised: 11-17-17
Revised: 7-5-23

ARKANSAS DEPARTMENT OF TRANSPORTATION

NOTICE OF NONDISCRIMINATION

The Arkansas Department of Transportation (ARDOT) complies with all civil rights provisions of federal statutes and related authorities that prohibit discrimination in programs and activities receiving federal financial assistance. Therefore, ARDOT does not discriminate on the basis of race, sex, color, age, national origin, religion (not applicable as a protected group under the Federal Motor Carrier Safety Administration Title VI Program), disability, Limited English Proficiency (LEP), or low-income status in the admission, access to and treatment in ARDOT's programs and activities, as well as ARDOT's hiring or employment practices. Complaints of alleged discrimination and inquiries regarding ARDOT's nondiscrimination policies may be directed to Civil Rights Officer Joanna P. McFadden (ADA/504/Title VI Coordinator), P. O. Box 2261, Little Rock, Arkansas 72203-2261, (501) 569-2298, (Voice/TTY 711), or the following email address: joanna.mcfadden@ardot.gov.

Free language assistance for Limited English Proficient individuals is available upon request.

This notice is available from the ADA/504/Title VI Coordinator in large print, on audiotape and in Braille.

Arkansas Department of Transportation
Supplemental Specifications and Special Provisions Listing
State Job Number SA1066

The following supplemental specifications and special provisions for this project supplement the standard specifications, edition of 2014. In case of conflict, the supplemental specifications and special provisions shall govern.

| | |
|----------|--|
| ERRATA | ERRATA FOR THE BOOK OF STANDARD SPECIFICATIONS |
| JOB SP | BIDDING REQUIREMENTS AND CONDITIONS |
| JOB SP | MANDATORY ELECTRONIC CONTRACT |
| JOB SP | MANDATORY ELECTRONIC DOCUMENT SUBMITTAL |
| JOB SP | LIQUIDATED DAMAGES PROCEDURE FOR BID LETTINGS |
| JOB SP | DESIGN AND QUALITY CONTROL OF ASPHALT MIXTURES |
| JOB SP | PERCENT AIR VOIDS AND NDESIGN FOR ACHM SURFACE MIX DESIGNS |
| JOB SP | SUBMISSION OF ASPHALT CONCRETE HOT MIX ACCEPTANCE TEST RESULTS |
| JOB SP | PRICE ADJUSTMENT FOR ASPHALT BINDER |
| JOB SP | PRICE ADJUSTMENT FOR FUEL |
| JOB SP | BROADBAND INTERNET SERVICE FOR ASPHALT CONCRETE PLANT |
| JOB SP | WARM MIX ASPHALT |
| JOB SP | RECYCLED ASPHALT SHINGLES |
| SP 108-1 | LIQUIDATED DAMAGES |
| SS 100-3 | CONTRACTOR'S LICENSE |
| SS 100-4 | DEPARTMENT NAME CHANGE |
| SS 102-2 | ISSUANCE OF PROPOSALS |
| SS 103-2 | CONTACT INFORMATION FOR MOTORIST DAMAGE CLAIMS |
| SS 105-4 | MAINTENANCE DURING CONSTRUCTION |
| SS 107-2 | RESTRAINING CONDITIONS |
| SS 108-2 | WORK ALLOWED PRIOR TO ISSUANCE OF WORK ORDER |
| SS 108-3 | WORK ORDER FOR FIXED COMPLETION DATE CONTRACTS |
| SS 303-1 | AGGREGATE BASE COURSE |
| SS 306-1 | QUALITY CONTROL AND ACCEPTANCE |
| SS 400-1 | TACK COATS |
| SS 400-4 | DESIGN AND QUALITY CONTROL OF ASPHALT MIXTURES |
| SS 400-5 | PERCENT AIR VOIDS FOR ACHM MIX DESIGNS |
| SS 400-6 | LIQUID ANTI-STRIP ADDITIVE |
| SS 400-7 | TRACKLESS TACK |
| SS 404-3 | DESIGN OF ASPHALT MIXTURES |
| SS 409-2 | ASPHALT LABORATORY FACILITY |
| SS 410-1 | CONSTRUCTION REQUIREMENTS AND ACCEPTANCE OF ASPHALT CONCRETE PLANT MIX COURSES |
| SS 410-2 | DEVICES FOR MEASURING DENSITY FOR ROLLING PATTERNS |
| SS 410-4 | EVALUATION OF ACHM SUBLOT REPLACEMENT MATERIAL |
| SS 416-1 | RECYCLED ASPHALT PAVEMENT |
| SS 604-1 | RETROREFLECTIVE SHEETING FOR TRAFFIC CONTROL DEVICES IN CONSTRUCTION ZONES |

Arkansas Department of Transportation
Supplemental Specifications and Special Provisions Listing
State Job Number SA1066

The following supplemental specifications and special provisions for this project supplement the standard specifications, edition of 2014. In case of conflict, the supplemental specifications and special provisions shall govern.

| | |
|----------|--|
| SS 604-3 | TRAFFIC CONTROL DEVICES IN CONSTRUCTION ZONES (MASH) |
| SS 723-1 | GENERAL REQUIREMENTS FOR SIGNS |
| SS 729-1 | CHANNEL POST SIGN SUPPORT |

ARKANSAS DEPARTMENT OF TRANSPORTATION

SUPPLEMENTAL SPECIFICATION

ERRATA FOR THE BOOK OF STANDARD SPECIFICATIONS

Errors noted in the printed book of Standard Specifications for Highway Construction, Edition of 2014, are listed below and this publication is hereby revised as follows:

- Page 124: The third sentence of the first paragraph of Subsection 110.03(c) should read: The Engineer will make a decision within 10 business days concerning the necessity or practicability of the request.
- Page 195: The sixth paragraph of subsection 303.02 should read: For Classes 1 through 8 materials, the fraction passing the #200 (0.075 mm) sieve shall not be greater than three-fourths of the fraction passing the #40 (0.0425 mm) sieve. For Classes 3 through 8, the fraction passing the #40 (0.425 mm) sieve shall have a liquid limit not greater than 25.
- Page 363: In the second paragraph of Subsection 502.02, the reference to ASTM 775 should be replaced by “ASTM A 775”.
- Page 636: In the second paragraph of Subsection 730.02, the references to AASHTO M 183 should be replaced with ASTM A36.
- Page 637: The last sentence of the second paragraph of Subsection 730.03 should read: All bolts, nuts, and washers shall be galvanized according to AASHTO M 232 or ASTM B 695, Class 40 or 50.
- Page 767: In the fourth paragraph of Subsection 807.06(a), the reference to ASTM B595 should be replaced by “ASTM B695”.
- Page 841: Subsection 817.04(a) should read: The treatment of lumber and timber shall meet the applicable requirements of the current edition of the AWWA, Standards U1, Commodity Specification E, Use Category UC4C.

ARKANSAS DEPARTMENT OF TRANSPORTATION

SPECIAL PROVISION

JOB NO. SA1066

BIDDING REQUIREMENTS AND CONDITIONS

Section 102 of the Standard Specifications for Highway Construction, Edition of 2014, is hereby amended as follows:

The fourth sentence of the second paragraph of **Subsection 102.01** is hereby deleted, and the following substituted therefore:

Prospective bidders may file a questionnaire at any time; however, prospective bidders will not be given authorization to submit a proposal unless a rating has been extended based on an acceptable questionnaire.

The last paragraph of **Subsection 102.01** is hereby deleted.

The second sentence of **Subsection 102.02** is hereby deleted, and the following substituted therefore:

The Notice to Contractors will contain a description of the proposed work, and information regarding access to proposal documents, plans, specifications, and the amount and nature of the proposal guaranty.

Subsection 102.03 is hereby deleted, renamed **Contents of Proposal Documents**, and the following substituted therefore:

The proposal documents will state the location and description of the contemplated construction and will show the estimate of the various quantities and kinds of work to be performed or materials to be furnished, and will have a schedule of items. The proposal documents will state the time in which the work must be completed, the amount of the proposal guaranty, and the date and time of the letting of work. The documents will also include any special provisions or requirements that vary from or are not contained in the standard specifications.

All forms included in the proposal documents are considered a part thereof. The plans, specifications, and other documents designated in the proposal documents will be considered a part of the proposal whether included or not.

The first through fourth paragraphs of **Subsection 102.04** are hereby deleted, and the following substituted therefore:

To become an eligible bidder, prospective bidders must be registered to bid in Arkansas with Bid Express. Prospective bidders must also contact the Program Management Division at (501) 569-2261 during regular business hours between the date the project is advertised and 4:30 p.m. on the day prior to the scheduled bid opening to request to become eligible to bid specific projects. Only prequalified contractors or their authorized representative may request to become an eligible bidder.

ARKANSAS DEPARTMENT OF TRANSPORTATION

SPECIAL PROVISION

JOB NO. SA1066

BIDDING REQUIREMENTS AND CONDITIONS

If the prospective bidder's prequalification rating is not "unlimited", the bidder shall file a certification with the Department citing all contracts in force and the unfinished value of such work. A prospective bidder will not be allowed to submit a proposal until a certification for the current bidding period is on file and the amount of work the contractor may be allowed to undertake is determined. The contractor's prequalification rating, less the unfinished value of all contracts in force, will determine the amount of additional work that the contractor may be allowed to undertake. A contractor will not be allowed to submit a proposal on an individual project for which the estimated cost is more than the amount that the contractor may be allowed to undertake, but the contractor will be allowed to submit a proposal on more than one project, providing that the estimated cost of each project is not more than the amount that the contractor may be allowed to undertake. In the event a contractor submits a low bid on more than one project and the aggregate amount is greater than the amount the contractor may be allowed to undertake, the Commission will exercise its discretion in the award of a particular project or projects.

A charge will be assessed for authorization to submit a proposal, paper copies of the proposal documents, and plans issued. These services are provided during regular business hours until 4:30 p.m. on the day prior to the scheduled bid opening at the Arkansas Department of Transportation, 10324 Interstate 30, Little Rock, Arkansas 72209, (501) 569-2261. Payment shall be made at the time services are provided or upon receipt of statement therefore. No refund will be allowed for bids not submitted or for plans or proposal documents returned.

The second sentence of the first paragraph of **Subsection 102.06** is hereby deleted, and the following substituted therefore:

The bidder is expected to examine carefully the site of the proposed work, the proposal documents, plans, specifications, supplemental specifications, and special provisions before submitting a proposal.

The first paragraph of **Subsection 102.07** is hereby deleted, and the following substituted therefore:

The proposal shall only be submitted through the internet bidding service, Bid Express. The bidder shall specify a unit price in figures for each pay item for which a quantity is given. A unit price of "zero" (\$0.00) is a valid price and will be considered. A blank unit price is not considered valid. The unit bid price should not be carried beyond 1 cent (\$0.01). Any figures on the unit bid price beyond 1 cent will be dropped.

The second and third paragraphs of **Subsection 102.07** are hereby deleted.

ARKANSAS DEPARTMENT OF TRANSPORTATION

SPECIAL PROVISION

JOB NO. SA1066

BIDDING REQUIREMENTS AND CONDITIONS

The fifth paragraph of **Subsection 102.07** is hereby deleted, and the following substituted therefore:

The bidder's proposal must be submitted with a digital signature containing the name of the individual, one or more members of the partnership, one or more members or officers of each firm representing a joint venture, or one or more officers of a corporation, or by an agent of the Contractor legally qualified and acceptable to the Department.

The sixth paragraph of **Subsection 102.07** is hereby deleted, and the following substituted therefore:

If the proposal is submitted with a digital signature of any person who is not listed in the bidder's Prequalification Questionnaire (Questionnaire Form) as the individual, as a partner of a partnership, or as an officer of a corporation, authorization for such submittal should be on file with the Department prior to the download of bids. This authorization shall be made before the downloading of bids and be in the form of a Power of Attorney duly executed and signed by an official with power to constitute such authority.

The last sentence of the seventh paragraph of **Subsection 102.07** is hereby deleted, and the following substituted therefore:

Those items of Asphalt Binder that are subject to a minimum bid price will bear the note "(Minimum bid price is \$120.00 per ton)" within the Schedule of Items of the proposal documents.

The first sentence of the ninth paragraph of **Subsection 102.07** is hereby deleted, and the following substituted therefore:

The proposal documents for all federal aid projects will contain a bidders list.

The last sentence of the ninth paragraph of **Subsection 102.07** is hereby deleted, and the following substituted therefore:

The information provided will not be used for contract awarding purposes but must be provided before the Contractor will be given authorization to submit proposals for future lettings.

Subsection 102.08 Irregular Proposals is hereby deleted, and the following substituted therefore:

- (a) Proposals will be considered irregular and will be rejected for the following reasons:
- (1) If the proposal does not contain a unit price for each pay item listed except in the case of authorized alternate pay items.
 - (2) If the proposal is not digitally signed by an authorized representative of the firm.

ARKANSAS DEPARTMENT OF TRANSPORTATION

SPECIAL PROVISION

JOB NO. SA1066

BIDDING REQUIREMENTS AND CONDITIONS

- (3) If the proposal is not accompanied by the proper proposal guaranty.
- (4) If a proposal is received from an individual, firm, partnership, or corporation with an interest, as principal, in another proposal for the same project.
- (5) If the proposal is not accompanied by the Certification to Submit DBE Participation.
- (b) Proposals will be considered irregular and may be rejected for the following reasons:
 - (1) If the proposal is not accompanied by a bid schedule and bid schedule narrative as required in the proposal documents.
 - (2) Unbalanced proposals in which the prices for some items are out of proportion to the reasonable costs representative of those items.
 - (3) If there are irregularities of any kind that may tend to make the proposal incomplete, indefinite, or ambiguous as to its meaning.

The first sentence of **Subsection 102.09** is hereby deleted and the following substituted therefore:

No proposal will be considered by the Commission unless a guaranty in the form of a bank draft, certified check, or cashier's check drawn on a solvent bank or trust company, or a bidder's paper bond executed by an approved surety company has been received by the Program Management Division prior to the download of bids.

The following paragraph is hereby added after the first paragraph of **Subsection 102.09**:

Electronic bid bonds are allowed. The prospective bidder should verify their bid bond in their proposal prior to submission.

Subsection 102.10 is hereby deleted and the following substituted therefore:

The proposal shall only be submitted through the internet bidding service, Bid Express.

Subsection 102.11 is hereby deleted, and the following substituted therefore:

A bidder may withdraw or modify a proposal after it has been submitted to Bid Express, up to the time set for the deadline for proposals to be received. A proposal may also be withdrawn if the Commission fails to make an award within 40 calendar days after the date of downloading.

ARKANSAS DEPARTMENT OF TRANSPORTATION

SPECIAL PROVISION

JOB NO. SA1066

BIDDING REQUIREMENTS AND CONDITIONS

Subsection 102.12 is hereby deleted, renamed **Downloading of Proposals**, and the following substituted therefore:

Proposals will be downloaded and then posted on the Department's website at the time and place indicated in the Notice to Contractors.

The last sentence of **Subsection 102.15** is hereby deleted, and the following substituted therefore:

In any case, the prospective bidders will be contacted prior to the download of bids.

ARKANSAS DEPARTMENT OF TRANSPORTATION

SPECIAL PROVISION

JOB NO. SA1066

MANDATORY ELECTRONIC CONTRACT

Paper Contract Documents and Forms will not be accepted.

The Department will only accept and execute an electronic contract for this project through Doc Express, a paperless contracting system. Prospective bidders will need to contact Doc Express to set up an account prior to the bid opening date. The toll-free phone number for Doc Express is 1-888-352-2439 and their website address is www.docexpress.com.

Section 103 of the Standard Specifications for Highway Construction, Edition of 2014, is hereby amended as follows.

The first sentence of **Subsection 103.06(a)** is hereby deleted, and the following substituted therefore:

The Contract shall be electronically signed by the successful bidder and electronically submitted to the Program Management Division, Construction Contract Procurement Section, together with the required bonds and proof of liability insurance, within 10 business days after the notice of award has been issued.

Subsection 103.08(d)(3)d. is hereby deleted, and the following substituted therefore:

Documentation of the bidder's commitment to use a DBE subcontractor whose participation it submits to meet a contract goal; and

Subsection 103.08(d)(3)e. is hereby deleted, and the following substituted therefore:

Document confirmation from the DBE that it is participating in the contract as provided in the Contractor's commitment.

Subsection 103.08(d)(5) is hereby deleted, and the following substituted therefore:

The preceding information shall be submitted directly to the Arkansas Department of Transportation, Program Management Division, via Doc Express.

ARKANSAS DEPARTMENT OF TRANSPORTATION

SPECIAL PROVISION

JOB NO. SA1066

MANDATORY ELECTRONIC DOCUMENT SUBMITTAL

Paper Document Submittals will not be accepted.

The Department will only accept electronically-submitted documents for consideration on this project. All correspondence and submittals to the Department shall be submitted through Doc Express, a paperless contracting system. When signed originals are required, the original shall be the document uploaded to Doc Express and the signature shall be the electronic signature applied through Doc Express. The Contractor shall use the same organizational account for project documentation as used to fulfill the requirements of the Mandatory Electronic Contract Special Provision. The toll-free phone number for Doc Express is 1-888-352-2439 and their website address is www.docexpress.com.

Any reference in the Standard Specifications to document submittal in writing or by U.S. Mail, facsimile, or in person is hereby amended to require that such documents be submitted using Doc Express with the following exceptions:

- Material delivery tickets which are used for payment or for field verification shall be submitted on paper as required by the Standard Specifications for Highway Construction, Edition of 2014.
- Any document with specific submittal requirements in state and/or federal law or federal regulations that conflict with the requirements of this Special Provision shall be submitted in accordance with such state and/or federal law or federal regulations.

A user guide is available on the Department's web page to assist Contractors with the use of Doc Express. The "Contractor Guide to Using Doc Express" is available on the Department's web page at <https://ardot.gov/divisions/construction/doc-express/>.

The Contractor may provide access for subcontractors to view and submit items in Doc Express by following the instructions provided in the "Contractor Guide to Using Doc Express". Once an organizational account is activated and the Contractor provides access to the contract, a subcontractor may submit documents to the Contractor in Doc Express by uploading the electronic documents as directed in the User Guide. Any documents uploaded by the subcontractor must be then retrieved and published by the Contractor within Doc Express for further action by the Engineer. The Engineer will not review or take any actions on any documents submitted by the subcontractor until the document has been appropriately submitted by the Contractor.

Any submittals, documents, subcontracts, proposals, working drawings, or any other items submitted by the Contractor within Doc Express are not considered approved by the Engineer until written notification of the approval is published by the Engineer in the "CON-Correspondence-From Department to Contractor" drawer in Doc Express. Any action taken by the Contractor prior to this notification is taken at the Contractor's own risk.

The Department's System Administration team has no authority to take action on any documents submitted to the system. Access for this team is for management of the application only. Knowledge of any document submitted is not imputed to the Department by the knowledge of Systems Administration.

The requirements of this Special Provision shall supersede the requirements of all other Special Provisions unless such Special Provision includes a stated exception to this Special Provision.

ARKANSAS DEPARTMENT OF TRANSPORTATION**SPECIAL PROVISION****JOB NO. SA1066****LIQUIDATED DAMAGES PROCEDURE FOR BID LETTINGS**

Department Standard Specification **Section 102.04** and **Supplemental Specification 102-2** state that the Department reserves the right to refuse to issue, accept, or consider a proposal:

“If the prospective bidder is the Contractor on a current Contract with the Commission on which Liquidated Damages are being assessed, and there are no pending time extensions warranted to remove the project from Liquidated Damages.”

If the prospective bidder goes into liquidated damages on a current Contract with the Commission during the advertisement period for a letting, the Contractor will be notified seven business days prior to the letting that they will not be allowed to bid in the upcoming letting. This notification will be officially transmitted through Doc Express for the project in liquidated damages and via email.

Upon notification that they will not be allowed to bid in the upcoming letting, the Contractor will be provided an opportunity to request a reconsideration of this decision. This request must be transmitted in the form of a letter through Doc Express and via email to the Department for review within two (2) business days of receipt. The Department will review the reconsideration request and render a decision no later than the Friday prior to the letting.

Please note, a bid may be withdrawn at any time prior to the time specified for the bid letting. If a Contractor has been notified that they will not be allowed to bid, and they do not withdraw their bid, the bid will be considered invalid and rejected.

ARKANSAS DEPARTMENT OF TRANSPORTATION

SPECIAL PROVISION

JOB NO. SA1066

DESIGN AND QUALITY CONTROL OF ASPHALT MIXTURES

Section 400 of the Standard Specifications for Highway Construction, Edition of 2014, is hereby amended as follows:

The eighth (8th) and tenth (10th) bullet within the first paragraph of **Subsection 404.01, Design of Asphalt Mixtures. (a) General** is hereby deleted and the following added:

- A one-gallon sample of performance grade asphalt binder to be used in all Section 405 Asphalt Concrete Hot Mix Base Course and Section 406 Asphalt Concrete Hot Mix Binder Course mix designs.
- Nine (9) blended aggregate samples for all Section 405 Asphalt Concrete Hot Mix Base Course and Section 406 Asphalt Concrete Hot Mix Binder Course mix designs.
- A two-gallon sample of performance grade asphalt binder to be used in all Section 407 Asphalt Concrete Hot Mix Surface Course mix designs.
- Fourteen (14) blended aggregate samples for all Section 407 Asphalt Concrete Hot Mix Surface Course mix designs.

The last sentence of the last paragraph of **Subsection 404.01 Design of Asphalt Mixtures. (a) General** is hereby deleted and the following substituted therefor:

At least fifteen (15) business days shall be allowed for the review of the mix design.

ARKANSAS DEPARTMENT OF TRANSPORTATION**SPECIAL PROVISION****JOB NO. SA1066****PERCENT AIR VOIDS AND NDESIGN FOR ACHM SURFACE MIX DESIGNS**

Supplemental Specification 400-5, Percent Air Voids for ACHM Mix Designs, is hereby amended as follows:

The fourth sentence of the first paragraph of **Subsection 404.01(b), Design Requirements**, is hereby deleted and the following substituted therefor:

The optimum asphalt content is the asphalt binder content at 4.0% air voids for ACHM Base and ACHM Binder Courses. The optimum asphalt content is the asphalt binder content at 3.5% air voids for ACHM Surface Courses.

The first bullet of the first paragraph of **Subsection 404.01(b), Design Requirements**, is hereby deleted and the following substituted therefor:

- All binder grades for ACHM Base and Binder Courses will be designed using 4.0% air voids and all binder grades for ACHM Surface Courses will be designed using 3.5% air voids.

The second paragraph of **Subsection 404.01(b), Design Requirements**, of the Standard Specifications, is hereby amended and the following added:

All ACHM Surface Courses will be designed at N_{des} of 60 gyrations.

The second sentence of the second paragraph of **Subsection 404.04, Quality Control of Asphalt Mixtures**, is hereby deleted and the following substituted therefor:

Adjustments to the accepted mix design to conform to actual production values without redesign of the mixture shall be based on production of the mixture at a target value of 4.0% air voids in ACHM Base and Binder Courses specimens and an asphalt binder content not less than that specified in the accepted mix design.

Adjustments to the accepted mix design to conform to actual production values without redesign of the mixture shall be based on production of the mixture at a target value of 3.5% air voids in ACHM Surface Course specimens and an asphalt binder content not less than that specified in the accepted mix design.

ARKANSAS DEPARTMENT OF TRANSPORTATION

SPECIAL PROVISION

JOB NO. SA1066

PERCENT AIR VOIDS AND NDESIGN FOR ACHM SURFACE MIX DESIGNS

Table 407--1 and Table 407--2 of **Subsection 407.04, Construction Requirements and Acceptance**, are hereby deleted and the following substituted therefor:

Table 407-1

Design Requirements for Asphalt Concrete Hot/Warm Mix Surface Course
(1/2" [12.5 mm])

Control Points

| Sieve (mm) | Percent Passing (%) |
|-----------------|---------------------|
| 3/4" (19.0) | 100 |
| 1/2" (12.5) | 90 - 100 |
| 3/8" (9.5) | 90 max. |
| No. 8 (2.36) | 28 - 58 |
| No. 16 (1.18) | - |
| No. 30 (0.60) | - |
| No. 50 (0.30) | - |
| No. 200 (0.075) | 3 - 7 |

| | | |
|---------------------------------|------------------------|----------------------|
| Asphalt Binder Content | Design Value | |
| % Air Voids | 3.5 | |
| % VMA | 14.5 – 16.0 | |
| Minimum Water Sensitivity Ratio | 80.0 | |
| % Anti-strip | As Required | |
| Fines to Asphalt Ratio* | 0.6 – 1.2 | |
| Wheel Tracking Test | <u>Design PG Grade</u> | <u>Maximum Rut</u> |
| (8000 Cycles, 100 psi, 64° C) | 64-22 or 67-22 | 0.315 in. (8.000 mm) |
| | 70-22 or 76-22 | 0.197 in. (5.000 mm) |

*Fines to asphalt ratio shall be defined as the percent materials passing the No. 200 (0.075 mm) sieve (expressed as a percent of total aggregate weight) divided by the effective asphalt binder content.

ARKANSAS DEPARTMENT OF TRANSPORTATION

SPECIAL PROVISION

JOB NO. SA1066

PERCENT AIR VOIDS AND NDESIGN FOR ACHM SURFACE MIX DESIGNS

Table 407-2

Design Requirements for Asphalt Concrete Hot/Warm Mix Surface Course
(3/8" [9.5 mm])

| | Control Points | |
|---------------------------------|------------------------|----------------------|
| Sieve (mm) | Percent Passing (%) | |
| 1/2" (12.5) | 100 | |
| 3/8" (9.5) | 90 - 100 | |
| No. 4 (4.75) | 90 max. | |
| No. 8 (2.36) | 32 - 67 | |
| No. 16 (1.18) | - | |
| No. 30 (0.60) | - | |
| No. 50 (0.30) | - | |
| No. 200 (0.075) | 3 - 7 | |
| Asphalt Binder Content | Design Value | |
| % Air Voids | 3.5 | |
| % VMA | 15.5 – 17.0 | |
| Minimum Water Sensitivity Ratio | 80.0 | |
| % Anti-strip | As Required | |
| Fines to Asphalt Ratio* | 0.6 – 1.2 | |
| Wheel Tracking Test | <u>Design PG Grade</u> | <u>Maximum Rut</u> |
| (8000 Cycles, 100 psi, 64° C) | 64-22 or 67-22 | 0.315 in. (8.000 mm) |
| | 70-22 or 76-22 | 0.197 in. (5.000 mm) |

*Fines to asphalt ratio shall be defined as the percent materials passing the No. 200 (0.075 mm) sieve (expressed as a percent of total aggregate weight) divided by the effective asphalt binder content.

ARKANSAS DEPARTMENT OF TRANSPORTATION

SPECIAL PROVISION

JOB NO. SA1066

PERCENT AIR VOIDS AND NDESIGN FOR ACHM SURFACE MIX DESIGNS

The Table 410-1 in **Subsection 410.09(b)**, **Acceptance of the Pavement**, of the Standard Specifications, is hereby amended as follows for ACHM Surface Courses:

**TABLE 410-1
COMPLIANCE, PRICE REDUCTION AND REJECTION LIMITS FOR ACHM SURFACE COURSES**

| Property | Compliance Limits | Price Reduction Limits | Lot Rejection Limits | Sublot Rejection Limits |
|--|----------------------------------|--------------------------------------|--------------------------------------|----------------------------------|
| Asphalt Binder Content | ±0.3 from mix design value | more than ±0.3 from mix design value | more than ±0.6 from mix design value | ±0.8 from mix design value |
| Air voids (AV) | 2.5% to 4.5% | 1.9% to 2.4% 4.6% to 5.0% | 1.8% or less 5.1% or more | 1.4% or less 5.6% or more |
| Voids in Mineral Aggregate (VMA)* ACHM Surface Course (1/2" [12.5 mm]) ACHM Surface Course (3/8" [9.5 mm]) | 14.0% to 16.5% 15.0% to 17.5% | 13.5% to 13.9% 16.6% to 17.0% | 13.4% or less 17.1% or more | 12.9% or less 17.6% or more |
| Density (% of theoretical) | 94.0% ± 2.0% | 91.0% to 91.9% 96.1 to 97.0% | 14.4% or less 18.1% or more | 13.9% or less 18.6% or more |
| Density (% of theoretical) where minimum specified is 90.0% | 90.0% to 96.0% | 89.0% to 89.9% 96.1% to 97.0% | 90.9% or less 97.1% or more | 89.9% or less** 98.1% or more |

*The values for VMA_(actual) shall be determined by calculating the VMA_(effective) and reducing it by the correction factor shown on the mix design.

**Subject to further evaluation, see text.

ARKANSAS DEPARTMENT OF TRANSPORTATION

SPECIAL PROVISION

JOB NO. SA1066

SUBMISSION OF ASPHALT CONCRETE HOT MIX ACCEPTANCE TEST RESULTS

Division 106 of the Standard Specifications for Highway Construction, Edition of 2014, is hereby amended as follows:

The following is hereby added to **Subsection 106.04, Acceptance of Materials**:

All ACHM Contractor Acceptance Tests shall be submitted electronically by use of the ACHM Microsoft Excel Spreadsheet for Contractors/Suppliers and on paper.

The ACHM Microsoft Excel Spreadsheet for Contractors/Suppliers can be downloaded from the following website:

<https://www.ardot.gov/divisions/construction/construction-information/contractor-achm-workbook/>.

To download this file and the supporting documentation, follow the instructions on the page linked above.

Use of this file requires Microsoft Excel 2000, 2003, or 2007.

The preferred method of transmitting the file is to e-mail the completed ACHM Microsoft Excel Spreadsheet for Contractors/Suppliers to the Department's ACHM Plant Inspector assigned to the project. It is also acceptable to transmit the file by Compact Disk (CD) or other electronic device. Regardless of the method of transmission used, the signed paper acceptance tests must be provided to the Resident Engineer via the required Document Submission system required by the Contract (Doc Express or eBuilder).

Any questions or issues arising from the use of this file should be referred to the Resident Engineer.

ARKANSAS DEPARTMENT OF TRANSPORTATION

SPECIAL PROVISION

JOB NO. SA1066

PRICE ADJUSTMENT FOR ASPHALT BINDER

A price adjustment clause is included in this Contract to provide additional compensation to the Contractor or a credit to the Department for fluctuations in asphalt binder prices. This price adjustment is dependent upon a change in the average price of asphalt binder which results in an increase or decrease in the price of products utilized on this project.

Payment. Payment will be made to the Contractor for monthly fluctuation in the price of asphalt binder used in performing the applicable items of Asphalt Concrete Hot Mix and Ultrathin Bonded Wearing Course work as listed in the table below when the asphalt binder price fluctuates from the base price defined below. Payment may be positive, negative, or nonexistent depending on the circumstances. Payments or deductions for the asphalt binder price adjustment will be included in the Contractors current estimates, and the payment or deduction authorized for each estimate will be based upon the quantities for applicable items of work.

The Asphalt Binder Price Adjustment will be a dollar amount paid as compensation to the Contractor, or as a credit to the Department as reflected on the Current (or Final) Estimate Summary Report as Payment Adjustments.

Asphalt Binder Price Adjustment (ABPA). The Asphalt Binder Price Adjustment (ABPA) for the current estimate will be computed according to the following formula:

$$ABPA = Q \times D \times (IQP / 100)$$

Where

- ABPA = Asphalt binder price adjustment, in dollars;
- Q = Quantities paid for the applicable items on the current estimate; tons of mix for ACHM items or square yards for Ultrathin Bonded Wearing Course
- D = Allowable price differential, in dollars;
- IQP = Item Quantity Percent, Quantity of Indexed Material per unit of the applicable item on the current estimate.

The above formula will be applied to each individual payment of the applicable item. When the Current (or Final) estimate is generated, the sum of these individual adjustments will be included as a Payment Adjustment.

| Applicable Items of Work | | |
|--|----------------------|-----------------------|
| ITEM OF WORK | SPECIFICATION NUMBER | ITEM QUANTITY PERCENT |
| Asphalt Binder in ACHM Base Course | 405 | 100 |
| Asphalt Binder in ACHM Binder Course | 406 | 100 |
| Asphalt Binder in ACHM Surface Course | 407 | 100 |
| Ultrathin Bonded Wearing Course (Type B) | SP | 5.5 |
| Ultrathin Bonded Wearing Course (Type C) | SP | 5.4 |

ARKANSAS DEPARTMENT OF TRANSPORTATION

SPECIAL PROVISION

JOB NO. SA1066

PRICE ADJUSTMENT FOR ASPHALT BINDER

The terms of this Special Provision will apply only to the items listed in this Special Provision table above. No other items on the contract will be subject to the terms of this Special Provision.

The allowable price differential, "D", for the current estimate will be computed according to the following formula, using the appropriate binder grades:

$$D = P - P(b)$$

P, the asphalt binder current price in dollars per ton, is the Monthly Asphalt Binder Price Index for the month in which the payment entry is entered.

P(b), the asphalt binder base price in dollars per ton, is the Monthly Asphalt Binder Price Index for the month in which the bids for the work were received.

Asphalt Binder Index Determination.

PG64-22 Binders. The Monthly Asphalt Binder Price Index for PG64-22 binders will be determined by calculating the average for performance-graded binder using the Selling Price of PG 64-22 paving grade. The monthly asphalt binder price will be an average of five asphalt binder prices. The prices will be furnished by the four largest asphalt binder suppliers in the State of Arkansas as determined by the previous calendar year. For an asphalt supplier to be included in the asphalt binder price index they must supply at least ten percent of the asphalt binder in Arkansas. The final component in the asphalt binder price index will be the Asphalt Weekly Monitor® furnished by Poten & Partners, Inc. The issue of the Asphalt Weekly Monitor® used will be for the last full week in the previous month received by the Department prior to the first day of the index month. The four largest suppliers included in the asphalt binder price index shall furnish the Department with their average price on the Thursday before the Friday of the last full week of the month. If any supplier fails to submit a price by this deadline, that supplier's price will not be included in the asphalt binder price index for that month.

PG70-22 and PG76-22 Binders (including Asphalt Binder in Ultrathin Bonded Wearing Course). The monthly Asphalt Binder Price Index for PG70-22 and PG76-22 binders (including asphalt binder in Ultrathin Bonded Wearing Course) will be determined by the same method above, except that the price from the Asphalt Weekly Monitor® will not be used in the calculation of the monthly average binder price. The monthly asphalt binder price for PG70-22 and PG76-22 binders will be calculated using the average of the prices supplied by the four largest binder suppliers in the State for those grades.

Supplemental Items Subject to Adjustment. Items included in the contract that are listed in the table above are subject to adjustment in accordance with this provision, regardless of any amount of overrun to the plan quantity. Any new items of work added to the Contract by supplemental agreement that are listed in the table above will be subject to the asphalt binder price adjustments in accordance with this provision. The base asphalt binder price, P(b), for any newly added eligible items will be the same P(b) as the eligible items in the Contract, and the new unit price established by supplemental agreement will be determined accordingly.

ARKANSAS DEPARTMENT OF TRANSPORTATION

SPECIAL PROVISION

JOB NO. SA1066

PRICE ADJUSTMENT FOR ASPHALT BINDER

Viewing Asphalt Binder Price Index. Historical asphalt binder price index values will be available in the "Asphalt Binder Index Report" document located on the ARDOT website at <https://ardot.gov/divisions/construction/construction-information/> under Asphalt Binder Information.

ARKANSAS DEPARTMENT OF TRANSPORTATION

SPECIAL PROVISION

JOB NO. SA1066

PRICE ADJUSTMENT FOR FUEL

A price adjustment clause is included in this Contract to provide additional compensation to the Contractor or a credit to the Department for fluctuations in diesel fuel prices. This price adjustment is dependent upon a change in the average price of fuel which results in an increase or decrease in the price of products utilized on this project. For the purposes of this specification, it is assumed that all fuel used is diesel fuel and that the fuel use factors shown in the table below cover all fuel used in delivery to the plant, production, hauling to the job site, placement, and finishing of the items of work shown.

Payment. Payment will be made to the Contractor for monthly fluctuation in the price of diesel fuel used in performing the applicable items as listed in the table below when the diesel fuel price fluctuates from the base price defined below. Payments may be positive, negative, or nonexistent depending on the circumstances. Payments or deductions for the fuel price adjustment will be included in the Contractor's current estimates, and the payment or deduction authorized for each estimate will be based upon the quantities for applicable items of work. Subcontracts should include the payment or deduction of fuel price adjustments on pay items listed in the table below when those items are included in a subcontract.

The Fuel Price Adjustment will be a dollar amount paid as compensation to the Contractor, or as a credit to the Department as reflected on the Current (or Final) Estimate Summary Report as Payment Adjustments.

Fuel Price Adjustment (FPA). The Fuel Price Adjustment (FPA) for the current estimate will be computed according to the following formula:

$$FPA = Q \times F \times D$$

Where

- FPA = Fuel price adjustment, in dollars;
- Q = Quantities paid for the applicable items on the current estimate,
- F = The Fuel Use Factor for the applicable items of work subject to this price adjustment, as listed in the table below,
- D = Allowable price differential, in dollars.

The above formula will be applied to each individual payment of the applicable item. When the Current (or Final) estimate is generated, the sum of these individual adjustments will be included as a Payment Adjustment.

ARKANSAS DEPARTMENT OF TRANSPORTATION

SPECIAL PROVISION

JOB NO. SA1066

PRICE ADJUSTMENT FOR FUEL

| Fuel Use Factors | | |
|---|-----------------------------|--------------------------|
| Item of Work | Specification Numbers | Fuel Use Factor Per Unit |
| Earthwork: (Unclassified Excavation, Compacted Embankment, Selected Material) | 210,302 | 0.34 gal./C.Y. |
| Soil Stabilization | Special Provision | 2.28 gal./ton |
| Shaping: (Shaping Roadway Section, Subgrade Preparation, Trenching and Shoulder Preparation, Scarifying and Recompacting Shoulders) | 213,214,215,216 | 2.52 gal./Station |
| Base Course and Stone: (Stone Backfill, Aggregate Base Course, Soil Aggregate in Cement Treated Base Course, Aggregate in Cement Stabilized Crushed Stone Base Course, Mineral Aggregate in Asphalt Surface Treatment) | 207,303,307,308,309,310,402 | 0.54 gal./ton |
| ACHM Paving: (ACHM Base Course, ACHM Binder Course, ACHM Surface Course, Open Graded Asphalt Base Course) | 405,406,407,417 | 2.36 gal./ton |
| Ultra-Thin Bonded Wearing Course (All Types) | Special Provision | 2.18 gal./ton |
| Milling: (Cold Milling Asphalt Pavement, Grinding Portland Cement Concrete Pavement) | 412, 510 | 0.18 gal./S.Y. |
| PCC Paving: (Portland Cement Concrete Base, Open Graded Portland Cement Concrete Base, Portland Cement Concrete Pavement, High Early Strength Concrete Pavement, Continuously Reinforced Concrete Pavement, Portland Cement Concrete Driveway) | 309, 310,501,503,505 | 0.44 gal./S.Y. |
| Structural Concrete (Approach Slabs, Approach Gutters, Class B Concrete-Bridge, Class S Concrete-Bridge, Class S(AE) Concrete-Bridge, Seal Concrete-Bridge, Class A Concrete-Roadway, Class S Concrete-Roadway) | 504, 802 | 1.75 gal./C.Y. |
| Flatwork: (Concrete Ditch Paving, Concrete Islands, Concrete Walks, Wheelchair Ramps) | 605,632,633,641 | 0.30 gal./S.Y. |

ARKANSAS DEPARTMENT OF TRANSPORTATION

SPECIAL PROVISION

JOB NO. SA1066

PRICE ADJUSTMENT FOR FUEL

When the units of measure in this contract for the items of work listed in the table do not correspond with the units shown in the table (i.e. Asphalt Concrete paid by the square yard, etc.), those items will not be subject to the terms of this special provision or any fuel price adjustment.

The allowable price differential, “D”, for the current estimate will be computed according to the following formula:

$$D = P - P(b)$$

P, the current fuel price in dollars per gallon, is the Monthly Fuel Price Index for the month in which the payment entry is entered.

P(b), the fuel base price in dollars per gallon, is the Monthly Fuel Price Index for the month in which the bids for the work were received.

Fuel Price Index Determination. The Monthly Fuel Price Index will be determined by using the On-Highway retail price for No. 2 Diesel Fuel – ULS (Ultra Low Sulfur), as listed for the US Gulf Coast region on the U.S. Energy Information Administration’s website. The value used will be that for either the closest Monday prior to the first calendar day of the index month or the first calendar day of the index month, if that is a Monday.

https://www.eia.gov/opendata/qb.php?sdid=PET.EMD_EPD2DXL0_PTE_R30_DPG.W

Supplemental Items Subject to Adjustment. Items included in the contract that are listed in the table above are subject to adjustment in accordance with this provision, regardless of any amount of overrun to the plan quantity. Any new items of work added to the Contract by supplemental agreement that are listed in the table above will be subject to the fuel price adjustments in accordance with this provision. The base fuel price, P(b), for any newly added eligible items will be the same P(b) as the eligible items in the Contract, and the new unit price established by supplemental agreement will be determined accordingly.

Viewing Fuel Price Index. Historical fuel price index values will be available in the “Asphalt Binder Index Report” document located on the ARDOT website under Fuel Price Information at <https://ardot.gov/divisions/construction/construction-information/>.

Opt Out Option. The Contractor, at its own discretion, can choose to opt out of the adjustments for fuel prices determined by this special provision. If the Contractor wishes to utilize this option, an authorized representative of the firm must sign the form on Page 4 of this special provision and submit it to the Department at PMD@ardot.gov prior to the time and date of the bid letting for this project. This representative must currently be listed with the Department as an officer approved to sign contracts in the firm’s name.

ARKANSAS DEPARTMENT OF TRANSPORTATION

SPECIAL PROVISION

JOB NO. SA1066

PRICE ADJUSTMENT FOR FUEL

OPT OUT OF PRICE ADJUSTMENTS TO FUEL

As an authorized representative of this company, I hereby choose the option to opt out of the price adjustments for fuel for all pay items allowable by this special provision for this contract. By signature of this form, my firm waives all payment adjustments for fuel indexing for the duration of this project and waives any subsequent appeals for additional compensation for fuel price fluctuations.

This action only applies to the construction contract for the job number listed in the header of this document.

Printed Name: _____ Title: _____

Signature: _____ Date: _____

Company Name: _____

NOTE: To opt out, this completed form must be submitted to the Department at PMD@ardot.gov prior to the time and date of the bid letting for this project.

ARKANSAS DEPARTMENT OF TRANSPORTATION

SPECIAL PROVISION

JOB NO. SA1066

BROADBAND INTERNET SERVICE FOR ASPHALT CONCRETE PLANT

Section 409.03(h) of the Standard Specifications for Highway Construction, Edition of 2014, is hereby amended as follows:

The following bullet is added under detailed requirements:

- Broadband Internet Service shall be provided.

The Broadband Internet Service shall be provided with an Internet Protocol (IP) address which is reachable on the global Internet (public) and which is permanently assigned (static). The Contractor is not required to provide this service if an IP address which is both static and public is not available.

If this service is not available at the beginning of a project but becomes available during the life of the project, the Contractor shall provide the service immediately from the date of availability.

The data transfer rate shall be 3 megabits per second (Mbps) download and 500 kilobits per second (kbps) upload, or higher, with latency not to exceed 150 milliseconds. If the Broadband Internet Service meets all of the requirements of this specification except for the data transfer rate and/or latency, then the best performing available connection shall be provided.

Prior to the selection of the Broadband Internet Service provider, the Contractor shall submit to the Resident Engineer, in writing, the proposed method for providing Broadband Internet Service. The Resident Engineer shall review this submittal and respond in writing regarding the acceptability of the proposed method.

The Broadband Internet Service shall be provided with equipment providing one Ethernet port.

ARKANSAS DEPARTMENT OF TRANSPORTATION

SPECIAL PROVISION

JOB NO. SA1066

WARM MIX ASPHALT

DESCRIPTION: The Department will allow the use of Warm Mix Asphalt (WMA). All provisions for the production and placement of conventional HMA mixtures as stipulated in Section 410 Construction Requirements and Acceptance of Asphalt Concrete Plant Mix Courses of the Standard Specifications for Highway Construction, Edition 2014, are applicable except as noted below.

Section 410 Construction Requirements and Acceptance of Asphalt Concrete Plant Mix Courses of the Standard Specifications for Highway Construction, Edition of 2014, is hereby amended as follows:

Section 410.03: Replace the third sentence with “WMA production temperatures at the plant shall be according to the Contractor’s approved mix design but may be adjusted based on recommendations of the WMA additive/process manufacturer.”

Add the following paragraph: “Implementation of best management practices in the control of aggregate moisture content prior to introduction to the drying or mixing drum is highly recommended in order to achieve the maximum benefit of WMA technology.”

Section 410.07: Replace the last sentence of the first paragraph with “Spreading and finishing temperatures shall be according to the Contractor’s approved mix design, but in no case shall the WMA be placed at a temperature less than 220° F.”

ARKANSAS DEPARTMENT OF TRANSPORTATION

SPECIAL PROVISION

JOB NO. SA1066

RECYCLED ASPHALT SHINGLES

DESCRIPTION: This specification covers the use of Recycled Asphalt Shingles (RAS) in Asphalt Concrete Hot Mix (ACHM).

MATERIALS: ACHM utilizing RAS shall meet all of the requirements of Sections 404, 409, 410, and 416 and the requirements of Section 405, 406, or 407 for the mixture type specified on the plans. The mix design will follow AASHTO MP 23-14 and AASHTO PP 78-14 except as follows:

- (1) A maximum of three (3) percent RAS by total mix weight will be allowed in any mix design. The amount of RAS will be included in the total Recycled Asphalt Pavement (RAP) percentage if RAP is used.
- (2) Shingle material shall be processed so that 100 percent passes the 3/8" (9.5 mm) sieve and ninety-five (95) percent passes the No. 4 (4.75 mm) sieve.
- (3) Pre-consumer, or manufacturer waste, shingles may be used in mix designs requiring PG 64-22 binder only.
- (4) Post-consumer, or tear-off, shingles may be used in mix designs requiring PG 64-22 binder only.
- (5) Pre- and post-consumer shingles may not be combined in mix designs.
- (6) Tear-off shingles shall be acquired from residential sources only and shall have been produced after 1980. In no case shall a roofing material containing rubber or rubber-like polymer components be used as RAS in asphalt mixes.
- (7) When using tear-off shingles, one stockpile test per lot of mix shall be conducted to confirm the binder content and gradation of the RAS product, and the sample shall be representative of the RAS material entering the production process for the lot tested. Binder content and gradation shall be determined using ARDOT 450 or AASHTO T 308. If AASHTO T 308 is used, the sample size shall be 400 grams, and the sample shall be oven dried to a constant mass (at a temperature not exceeding 140°F) prior to testing. Shingle fibers shall be removed from the extracted sample prior to gradation testing.

ARKANSAS DEPARTMENT OF TRANSPORTATION
SPECIAL PROVISION
LIQUIDATED DAMAGES

As specified in the Contract, liquidated damages for this project will be as shown in the following table:

WORKING DAY PROJECTS

| ORIGINAL CONTRACT AMOUNT | | |
|---------------------------------|-------------------------|-------------|
| FROM MORE THAN | TO AND INCLUDING | RATE |
| \$ 0 | \$ 100,000 | \$ 140 |
| 100,000 | 500,000 | 400 |
| 500,000 | 1,000,000 | 660 |
| 1,000,000 | 2,000,000 | 800 |
| 2,000,000 | 5,000,000 | 1,380 |
| 5,000,000 | 10,000,000 | 1,800 |
| 10,000,000 | 15,000,000 | 2,620 |
| 15,000,000 | 20,000,000 | 2,720 |
| 20,000,000 | 30,000,000 | 2,940 |
| 30,000,000 | ----- | 3,500 |

FIXED DATE PROJECTS

| ORIGINAL CONTRACT AMOUNT | | |
|---------------------------------|-------------------------|-------------|
| FROM MORE THAN | TO AND INCLUDING | RATE |
| \$ 0 | \$ 100,000 | \$ 60 |
| 100,000 | 500,000 | 80 |
| 500,000 | 1,000,000 | 220 |
| 1,000,000 | 2,000,000 | 300 |
| 2,000,000 | 5,000,000 | 420 |
| 5,000,000 | 10,000,000 | 1,000 |
| 10,000,000 | 15,000,000 | 1,200 |
| 15,000,000 | 20,000,000 | 1,300 |
| 20,000,000 | 30,000,000 | 1,400 |
| 30,000,000 | ----- | 1,520 |

ARKANSAS DEPARTMENT OF TRANSPORTATION

SUPPLEMENTAL SPECIFICATION

CONTRACTOR'S LICENSE

Section 102 of the Standard Specifications for Highway Construction, Edition of 2014, is hereby amended as follows:

The third paragraph of **Subsection 102.01, Prequalification of Bidders**, is hereby deleted and the following substituted thereof:

The attention of prospective bidders is directed to Ark. Code Ann. §17-25-101 et seq., Act 150 of the 1965 Acts of Arkansas, being an "Act Regulating the Practice of Contracting in the State of Arkansas", and any subsequent amendments made thereto. When the work offered is financed in whole with State funds and is estimated to cost \$50,000 or more, the prospective bidder must show evidence of its license and evidence of registration or license of its subcontractors with the Contractors Licensing Board for the State of Arkansas before being furnished with a proposal form.

The third paragraph of **Subsection 108.01, Subletting of Contract**, is hereby deleted and the following substituted thereof:

It shall be the responsibility of the Contractor to determine that all parties performing work amounting to \$50,000 or more are currently licensed or registered by the Contractors Licensing Board for the State of Arkansas.

ARKANSAS DEPARTMENT OF TRANSPORTATION
SUPPLEMENTAL SPECIFICATION
DEPARTMENT NAME CHANGE

All references to the Arkansas State Highway and Transportation Department contained within the Standard Specifications for Highway Construction (Edition of 2014), the Qualified Products List, the Manual of Field Sampling and Testing Procedures, plan sheets, Supplemental Specifications, and all Special Provisions contained in this proposal are hereby deleted and replaced with the title of Arkansas Department of Transportation.

All references to AHTD contained within the Standard Specifications for Highway Construction (Edition of 2014), the Qualified Products List, the Manual of Field Sampling and Testing Procedures, plan sheets, Supplemental Specifications, and all Special Provisions contained in this proposal are hereby deleted and replaced with the abbreviation ARDOT.

All references to the Arkansas State Highway Commission contained within the Standard Specifications for Highway Construction (Edition of 2014), the Qualified Products List, the Manual of Field Sampling and Testing Procedures, the Standard Drawings, plan sheets, Supplemental Specifications, and all Special Provisions contained in this proposal remain in effect.

ARKANSAS DEPARTMENT OF TRANSPORTATION
SUPPLEMENTAL SPECIFICATION
ISSUANCE OF PROPOSALS

Section 102 of the Standard Specifications for Highway Construction, Edition of 2014, is hereby amended as follows:

Subsection 102.04(j) is hereby deleted and the following is substituted therefore:

(j) If the prospective bidder is the Contractor on a current Contract with the Commission on which Liquidated Damages are being assessed, and there are no pending time extensions warranted to remove the project from Liquidated Damages.

Subsection 102.04(k) is hereby deleted and the following is substituted therefore:

(k) If the prospective bidder has a current Contract in default.

ARKANSAS DEPARTMENT OF TRANSPORTATION

SUPPLEMENTAL SPECIFICATION

CONTACT INFORMATION FOR MOTORIST DAMAGE CLAIMS

Section 103, AWARD AND EXECUTION OF CONTRACT, of the Standard Specifications for Highway Construction, Edition of 2014, is hereby amended as follows:

The following is added as the fourth paragraph of **Subsection 103.05(b), Liability Insurance**:

Prior to beginning construction, the Contractor shall provide the Engineer with the name, phone number and e-mail address for the individual within their organization responsible for submission of claims for damages to motorists' vehicles inside the work zones. This information shall be updated annually or whenever this responsibility changes within the Contractor's organization. The information will be made available to the public on the Department's webpage.

ARKANSAS DEPARTMENT OF TRANSPORTATION
SUPPLEMENTAL SPECIFICATION
MAINTENANCE DURING CONSTRUCTION

Division 100 of the Standard Specifications for Highway Construction, Edition of 2014, is hereby amended as follows:

Subsection 105.15 is hereby modified as follows:

The first paragraph of **Subsection 105.15** is hereby deleted and the following substituted therefor:

105.15 Maintenance During Construction. The Contractor shall maintain the work during construction and until the project is accepted. For contracts containing a Flexible Beginning of Work special provision, the responsibility for maintenance by the Contractor will begin at the earlier date of the following:

- when the Contractor begins work, or
- on the date of the beginning of time charges in accordance with the Work Order if the Contractor has not commenced work.

This maintenance shall constitute continuous and effective work prosecuted day by day, with adequate equipment and forces, to the end that the roadway or structures are kept in satisfactory condition at all times.

ARKANSAS DEPARTMENT OF TRANSPORTATION
SUPPLEMENTAL SPECIFICATION
RESTRAINING CONDITIONS

Section 107 of the Standard Specifications for Highway Construction, Edition of 2014, is hereby amended as follows:

The following is hereby added after the first bullet of the first paragraph of **Subsection 107.10 Restraining Conditions (a), General**:

- Human remains, burials, and/or associated burial artifacts

The following is hereby added after the second paragraph of **Subsection 107.10 (b), Restraining Conditions Within the Right-of-Way**:

When restraining conditions under (1) and (2) below are encountered, the following provisions should be executed.

(1) If archeological sites and/or historically significant cultural resources are unexpectedly impacted or subsequently discovered during construction, the Contractor shall stop work with no ground-disturbing activities occurring within a two hundred (200)-foot radius of the location of the discovery. The Engineer shall be notified immediately, who will then notify the Environmental Division. A Department staff archeologist will inspect the discovery and determine if the established buffer radius is appropriate. The radius may be decreased or increased based on the nature of the discovery at the discretion of the archeologist. Work in the buffer radius shall not resume until the Environmental Division has provided written notification to the Engineer that construction activities can proceed.

(2) If human remains, burials, and/or associated burial artifacts are encountered during construction, the Contractor shall stop work with no ground-disturbing activities occurring within a two hundred (200)-foot radius of the location of the discovery and the location secured and protected by flagging or fencing. The human remains shall be covered with a canvas tarp and shall not be removed or collected. The Engineer shall be notified immediately, who then will notify the Environmental Division. A Department staff archeologist will inspect the remains and determine if the established buffer is appropriate. The radius may be decreased or increased based on the nature of the discovery at the discretion of the archeologist. The local law enforcement and Chief Medical Examiner will be notified by the Environmental Division. Work in the buffer radius shall not resume until the Environmental Division has provided written notification to the Engineer that construction activities can proceed.

ARKANSAS DEPARTMENT OF TRANSPORTATION
SUPPLEMENTAL SPECIFICATION
RESTRAINING CONDITIONS

The following is hereby added after the third sentence of the first paragraph of **Subsection 107.10 (c), Restraining Conditions Outside the Right-of-Way, (2) Non-commercially Operated Site:**

The Contractor shall limit the amount of acres submitted for an off-site location to no more than 10 acres, except for commercial areas, previously approved locations, or where previous ground disturbance exists. If a Contractor requires more than 10 acres for a proposed off-site location, the Contractor may, at no cost to the Department, acquire approval for use of the site from the State Historic Preservation Officer and a qualified archeological consultant.

ARKANSAS DEPARTMENT OF TRANSPORTATION
SUPPLEMENTAL SPECIFICATION
WORK ALLOWED PRIOR TO ISSUANCE OF WORK ORDER

Section 108 of the Standard Specifications for Highway Construction, Edition of 2014, is hereby amended as follows:

Subsection 108.02(b)(2) is hereby deleted and the following is substituted therefore:

(2) The delivery to the Department for execution of the Contract and bonds properly executed on behalf of the Contractor and surety and the minimum 72 hours advance notice as required above shall constitute the Contractor's authority to begin the following items of work:

- Mobilization;
- Preparation of shop drawings and other required submissions;
- Ordering, fabrication, assembly, and/or stockpiling of materials;
- Driving Test Piling; and
- Contract surveying, when Roadway and/or Bridge Construction Control is included in the Contract.
- Erection of advance warning signs.
- Installation of netting on structures to prevent nesting of migratory birds in accordance with applicable Special Provisions (if included in the Contract).
- Set up, installation, and testing of Automated Work Zone Information Systems (if included in the Contract).
- Off-site area approval process per Section 107.10(c).

Such advance work shall be subject to the Contractor's assumption of the risk of cancellation of the award and the following:

- The Contractor shall, on commencing such operations, take all precautions required for public safety and shall observe all the provisions in the Contract;
- In the event of cancellation of the award, the Contractor shall at Contractor expense do such work as necessary to leave the site in a neat condition to the satisfaction of the Engineer;
- In the event of cancellation of the award, all work performed shall be deemed to be at the Contractor's expense; and
- All work done under this subsection in accordance with the Contract before its execution by the Commission will, when the Contract is executed, be considered authorized work and will be paid for as provided in the Contract.

Unless otherwise notified in writing, no time will be assessed for work performed prior to the effective date of a Work Order.

No payments will be made prior to the date established by the Engineer under Subsection 109.07, which date will be after the effective date of a Work Order.

The Contractor shall not be entitled to any additional compensation or an extension of time for any delay, hindrance, or interference caused by or attributable to commencement of work before the effective date of a Work Order.

ARKANSAS DEPARTMENT OF TRANSPORTATION

SUPPLEMENTAL SPECIFICATION

WORK ORDER FOR FIXED COMPLETION DATE CONTRACTS

Section 108, Prosecution and Progress, of the Standard Specifications for Highway Construction, Edition of 2014, is hereby amended as follows:

Subsection 108.02(b)(4) a. is hereby deleted, and the following is substituted therefor:

a. Fixed Completion Date Contract. Unless the Contractor is otherwise advised in writing, the Work Order for a fixed completion date contract shall become effective on the second business day following the execution of the Contract by the Department. (Example: If the contract is executed on Wednesday, March 1, the Work Order will be effective on Friday, March 3.) Should the effective date fall on Saturday, Sunday, legal holiday designated in Subsection 101.01(c), Monday following a holiday on Sunday, or Friday preceding a holiday on Saturday, the effective date shall still be on the second business day. The written Work Order from the Engineer will follow with the effective date being as specified.

ARKANSAS DEPARTMENT OF TRANSPORTATION
SUPPLEMENTAL SPECIFICATION
AGGREGATE BASE COURSE

Section 303 of the Standard Specifications for Highway Construction, Edition 2014, is hereby amended as follows:

The second paragraph of **Subsection 303.02, Materials** is hereby deleted and the following substituted therefor:

The Contractor shall have the option of using any higher numbered class Aggregate Base Course than that specified, provided that payment will be for the class specified. Acceptance criteria shall be for the class specified. Different classes of Aggregate Base Course shall not be mixed in the same location.

ARKANSAS DEPARTMENT OF TRANSPORTATION
SUPPLEMENTAL SPECIFICATION
QUALITY CONTROL AND ACCEPTANCE

Division 300 of the Standard Specifications for Highway Construction, Edition of 2014, is hereby amended as follows:

The first sentence of the third paragraph **Subsection 306.03 Acceptance Testing** is hereby deleted and the following substituted therefor:

If the material being furnished is crushed stone the Department will furnish the PL, LL, and PI for the material, further tests for PL, LL, and PI are waived.

ARKANSAS DEPARTMENT OF TRANSPORTATION
SUPPLEMENTAL SPECIFICATION
TACK COATS

Division 400 of the Standard Specifications for Highway Construction, Edition of 2014, is hereby amended as follows:

Section 401, Prime and Tack Coats and Emulsified Asphalt in Base Course, is hereby modified as follows:

The first sentence of **Subsection 401.03(a)** is hereby deleted and the following substituted therefore:

The surface to be treated with prime or tack coat shall be cleaned of dust, dirt, and loose or foreign material by sweeping with mechanical brooms immediately preceding the application of the prime or tack coat.

Third sentence of **Subsection 401.03(c)** is hereby deleted and the following is substituted therefore:

No dilution beyond that which is part of the emulsification process is permitted. The tack coat shall not be diluted, cut, or otherwise thinned after receipt from the manufacturer's facility.

The fifth sentence of **Subsection 401.03(c)** is hereby deleted and the following substituted therefore:

The rate of application shall be from 0.03 gallon to 0.10 gallon per square yard (0.1 L/sq m to 0.5 L/sq m) of residual asphalt as designated by the Engineer.

Section 410, Construction Requirements and Acceptance of Asphalt Concrete Plant Mix Courses, is hereby modified as follows:

The sixth paragraph of **Subsection 410.05** is hereby deleted and the following substituted therefore:

For foreign material, or when the time lapse between courses is more than 8 hours, the earlier course shall be cleaned and given a tack coat before placing the succeeding course. When directed, the tack coat shall be applied and paid for under Section 401. If directed by the Engineer, a tack coat shall be used even though the elapsed time has been less than 8 hours.

ARKANSAS DEPARTMENT OF TRANSPORTATION
SUPPLEMENTAL SPECIFICATION
DESIGN AND QUALITY CONTROL OF ASPHALT MIXTURES

Division 400 of the Standard Specifications for Highway Construction, Edition of 2014, is hereby amended as follows:

Section 404, QUALITY CONTROL OF ASPHALT MIXTURES, is hereby modified as follows:

The fifth sentence of the second paragraph of **Subsection 404.01, Design of Asphalt Mixtures, (a) General**, is hereby deleted and the following substituted therefor:

A mix design that has not been produced on an ARDOT project in the last two years is inactive. The Contractor may submit a passing field verification test for the inactive asphalt mix design to the Materials Division to be reactivated. Asphalt mix designs with an expiration date may remain in production if they are not inactive.

The third through fifth paragraphs of **Subsection 404.04, Quality Control of Asphalt Mixtures**, are hereby deleted and the following substituted therefor:

The accepted mix design shall be field verified by the Contractor at the start of mix production or after an interruption of more than 120 calendar days. Production of Department approved mix designs for placement on non-ARDOT projects may be used for mix verification. The Contractor shall be allowed two attempts to verify the mix design if being placed on an ARDOT project and three attempts to verify the mix design if being placed on a non-ARDOT project. The Contractor shall notify the Engineer sufficiently in advance for Department personnel to witness all testing of this production and shall provide copies of all test results to the Department.

Verification will begin with testing the plant produced mix using the aggregate proportions and asphalt binder content shown on the accepted mix design. After the first attempt of verification of the initial design, the Contractor may elect to adjust aggregate proportions to vary the accepted mix design gradations and bring the mix properties near the center of the compliance limits. If the mix is in subplot rejection, all future attempts will only be allowed on non-ARDOT projects.

The mix will be verified if the test values for air voids, asphalt binder content, and VMA are within the compliance limits shown in Table 410-1, and when the accepted mix design has been produced within the gradation tolerances according to Subsection 404.04.

The Contractor may request a one-time field mix design be accepted by the Engineer of Materials. The Contractor will be notified in writing if the field mix design is accepted. A field mix design allows the Contractor to use the adjusted aggregate proportions for future verification of the mix design. Cold feed adjustments will be allowed to both the initial mix design and field mix design if they do not exceed more than 10% for any single cold feed or 20% overall from the initial mix design. No individual cold feed will be allowed to be eliminated by such changes. Gradation tolerances will be based off the initial job mix formula. All cold feed adjustments exceeding the limits outlined above will require a new mix design.

Once verified, the asphalt binder content shall be adjusted at the plant to obtain the optimum asphalt binder content shown on the mix design during production based on the lot average. At no time shall the asphalt binder content be adjusted in a manner to produce an asphalt binder content lower

ARKANSAS DEPARTMENT OF TRANSPORTATION
SUPPLEMENTAL SPECIFICATION
DESIGN AND QUALITY CONTROL OF ASPHALT MIXTURES

than the design value. Adjustments to the asphalt binder content are not allowed for control of any volumetric property. All changes to be made to the asphalt binder content must first be reported to the Engineer. If adjustments do not give the intended result, production shall be stopped, and the asphalt plant and equipment shall be recalibrated and adjusted so the asphalt binder content can be successfully obtained.

The test method ARDOT 461, (NOTE 3), and (NOTE 4) in the table of the tenth paragraph of **Subsection 404.04, Quality Control of Asphalt Mixtures**, are hereby deleted.

The thirteenth and fourteenth paragraphs of **Subsection 404.04, Quality Control of Asphalt Mixtures, NOTE 3 and NOTE 4** are hereby deleted.

The eighteenth paragraph of **Subsection 404.04, Quality Control of Asphalt Mixtures**, is hereby deleted.

The fourth and fifth sentences in the nineteenth paragraph of **Subsection 404.04, Quality Control of Asphalt Mixtures**, are hereby deleted and the following substituted therefor:

Individual aggregate cold feeds should be adjusted to bring the mix design properties near the center of compliance limits. If excessive changes are required, production will be suspended, and a new mix design shall be developed according to the applicable specifications. Excessive changes are cold feed adjustments that exceed more than 10% for any single cold feed change or 20% overall from the initial mix design. No individual cold feed will be allowed to be eliminated by such changes. All cold feed adjustments exceeding the limits outlined above will require a new mix design.

Section 410, CONSTRUCTION REQUIREMENTS AND ACCEPTANCE OF ASPHALT CONCRETE PLANT MIX COURSES, is hereby modified as follows:

The first through third sentences in the first paragraph of **Subsection 410.09(a), General**, are hereby deleted and the following is substituted therefor:

The accepted mix design shall be verified by the Contractor at the start of mix production for that design or after an interruption of more than 120 calendar days. A maximum of 200 tons (200 metric tons) of materials may be placed on the roadway during the verification process. If the mix produced does not verify the mix design, the material placed on the roadway shall be declared a partial lot. If all verification attempts have been exhausted, a new mix design shall be required.

Section 411, ASPHALT CONCRETE COLD PLANT MIX, is hereby modified as follows:

The third sentence of **Subsection 411.05 (b), Acceptance**, is hereby amended and the following is substituted therefor:

The accepted mix design shall be field verified by the Contractor at the start of mix production or after an interruption of more than 120 calendar days.

ARKANSAS DEPARTMENT OF TRANSPORTATION
SUPPLEMENTAL SPECIFICATION
PERCENT AIR VOIDS FOR ACHM MIX DESIGNS

Division 400 of the Standard Specifications for Highway Construction, Edition of 2014, is hereby amended as follows:

The fourth sentence of Paragraph 1 of **Subsection 404.01(b), Design Requirements**, is hereby deleted and the following substituted therefor:

The optimum asphalt content is the asphalt binder content at 4% Air Voids (AV).

The first bullet of Paragraph 1 is hereby deleted and the following substituted therefor:

- PG 64-22 and PG 70-22 mixes will be designed using 4% air voids;

The second sentence of Paragraph 2 of **Subsection 404.04, Quality Control of Asphalt Mixtures**, is hereby deleted and the following substituted therefor:

Adjustments to the accepted mix design to conform to actual production values without re-design of the mixture shall be based on production of the mixture at a target value of 4.0% Air Voids (AV) in specimens and an asphalt binder content not less than that specified in the accepted mix design.

Table 405-1 of **Subsection 405.03 Materials** is hereby deleted and the following substituted therefor:

| Table 405-1 | | |
|--|------------------------|----------------------|
| Design Requirements for Asphalt Concrete Hot Mix Base Course | | |
| (1-1/2" [37.5 mm]) | | |
| Control Points | | |
| Sieve (mm) | Percent Passing (%) | |
| 2" (50.0) | 100 | |
| 1½" (37.5) | 90 - 100 | |
| 1" (25.0) | 90 max. | |
| No. 4 (4.75) | - | |
| No. 8 (2.36) | 15 - 41 | |
| No. 16 (1.18) | - | |
| No. 30 (0.60) | - | |
| No. 50 (0.30) | - | |
| No. 200 (0.075) | 0 - 6 | |
| Asphalt Binder Content | Design Value | |
| % Air Voids | 4.0 | |
| % VMA | 11.5 – 13.0 | |
| Minimum Water Sensitivity Ratio | 80.0 | |
| % Anti-strip | As Required | |
| Fines to Asphalt Ratio* | 0.6 – 1.6 | |
| Wheel Tracking Test | <u>Design Gyration</u> | <u>Maximum Rut</u> |
| (8000 cycles, 100 psi, 64°C) | 75 & 115 | 0.315 in. (8.000 mm) |
| | 160 | 0.197 in. (5.000 mm) |
| | 205 | 0.197 in. (5.000 mm) |

*Fines to asphalt ratio shall be defined as the percent materials passing the No. 200 (0.075 mm) sieve (expressed as a percent of total aggregate weight) divided by the effective asphalt binder content.

ARKANSAS DEPARTMENT OF TRANSPORTATION
SUPPLEMENTAL SPECIFICATION
PERCENT AIR VOIDS FOR ACHM MIX DESIGNS

Table 406-1 of **Subsection 406.04, Construction Requirements and Acceptance**, is hereby deleted and the following substituted therefor:

| Table 406-1 | | |
|--|------------------------|----------------------|
| Design Requirements for Asphalt Concrete Hot Mix Binder Course (1" [25 mm]) | | |
| Control Points | | |
| Sieve (mm) | Percent Passing (%) | |
| 1½" (37.5) | 100 | |
| 1" (25.0) | 90 - 100 | |
| ¾" (19.0) | 90 max. | |
| No. 4 (4.75) | - | |
| No. 8 (2.36) | 19 - 45 | |
| No. 16 (1.18) | - | |
| No. 30 (0.60) | - | |
| No. 50 (0.30) | - | |
| No. 200 (0.075) | 1 - 7 | |
| Asphalt Binder Content | Design Value | |
| % Air Voids | 4.0 | |
| % VMA | 12.5 – 14.0 | |
| Minimum Water Sensitivity Ratio | 80 | |
| % Anti-strip | As Required | |
| Fines to Asphalt Ratio* | 0.6 – 1.6 | |
| Wheel Tracking Test (8000 cycles, 100 psi, 64°C) | <u>Design Gyration</u> | <u>Maximum Rut</u> |
| | 75 & 115 | 0.315 in. (8.000 mm) |
| | 160 | 0.197 in. (5.000 mm) |
| | 205 | 0.197 in. (5.000 mm) |

*Fines to asphalt ratio shall be defined as the percent materials passing the No. 200 (0.075 mm) sieve (expressed as a percent of total aggregate weight) divided by the effective asphalt binder content.

ARKANSAS DEPARTMENT OF TRANSPORTATION
SUPPLEMENTAL SPECIFICATION
PERCENT AIR VOIDS FOR ACHM MIX DESIGNS

Table 407-1 and Table 407-2 of **Subsection 407.04, Construction Requirements and Acceptance**, are hereby deleted and the following substituted therefor:

| Table 407-1 | | |
|---|------------------------|----------------------|
| Design Requirements for Asphalt Concrete Hot Mix Surface Course (1/2" [12.5 mm]) | | |
| Control Points | | |
| Sieve (mm) | Percent Passing (%) | |
| 3/4" (19.0) | 100 | |
| 1/2" (12.5) | 90 - 100 | |
| 3/8" (9.5) | 90 max. | |
| No. 8 (2.36) | 28 - 58 | |
| No. 16 (1.18) | - | |
| No. 30 (0.60) | - | |
| No. 50 (0.30) | - | |
| No. 200 (0.075) | 2 - 10 | |
| Asphalt Binder Content | Design Value | |
| % Air Voids | 4.0 | |
| % VMA | 14.0 – 16.0 | |
| Minimum Water Sensitivity Ratio | 80.0 | |
| % Anti-strip | As Required | |
| Fines to Asphalt Ratio* | 0.6 – 1.6 | |
| Wheel Tracking Test (8000 cycles, 100 psi, 64°C) | <u>Design Gyration</u> | <u>Maximum Rut</u> |
| | 75 & 115 | 0.315 in. (8.000 mm) |
| | 160 | 0.197 in. (5.000 mm) |
| | 205 | 0.197 in. (5.000 mm) |

*Fines to asphalt ratio shall be defined as the percent materials passing the No. 200 (0.075 mm) sieve (expressed as a percent of total aggregate weight) divided by the effective asphalt binder content.

ARKANSAS DEPARTMENT OF TRANSPORTATION
SUPPLEMENTAL SPECIFICATION
PERCENT AIR VOIDS FOR ACHM MIX DESIGNS

Table 407-2

Design Requirements for Asphalt Concrete Hot Mix Surface Course (3/8" [9.5 mm])

| | Control Points | |
|---------------------------------|------------------------|-----------------------|
| Sieve (mm) | Percent Passing (%) | |
| ½" (12.5) | 100 | |
| 3/8" (9.5) | 90 - 100 | |
| No. 4 (4.75) | 90 max. | |
| No. 8 (2.36) | 32 - 67 | |
| No. 16 (1.18) | - | |
| No. 30 (0.60) | - | |
| No. 50 (0.30) | - | |
| No. 200 (0.075) | 2 - 10 | |
| Asphalt Binder Content | Design Value | |
| % Air Voids | 4.0 | |
| % VMA | 15.0 – 17.0 | |
| Minimum Water Sensitivity Ratio | 80.0 | |
| % Anti-strip | As Required | |
| Fines to Asphalt Ratio* | 0.6 – 1.6 | |
| Wheel Tracking Test | <u>Design Gyration</u> | <u>Maximum Rut</u> |
| (8000 cycles, 100 psi, 64°C) | 75 & 115 | 0.315 in. (8.000 mm.) |
| | 160 | 0.197 in. (5.000 mm) |
| | 205 | 0.197 in. (5.000 mm) |

*Fines to asphalt ratio shall be defined as the percent materials passing the No. 200 (0.075 mm) sieve (expressed as a percent of total aggregate weight) divided by the effective asphalt binder content.

ARKANSAS DEPARTMENT OF TRANSPORTATION

SUPPLEMENTAL SPECIFICATION

LIQUID ANTI-STRIP ADDITIVE

Division 400 of the Standard Specifications for Highway Construction, Edition of 2014, is hereby amended as follows:

Section 404, DESIGN AND QUALITY CONTROL OF ASPHALT MIXTURES, is hereby modified as follows:

The following is added as the last bullet following the first paragraph of **Subsection 404.01(b), Design Requirements**:

- All ACHM mixes must contain a liquid, anti-strip additive.

Section 409, MATERIALS AND EQUIPMENT FOR ASPHALT CONCRETE PLANT MIX COURSES, is hereby modified as follows:

The second paragraph of **Subsection 409.02 Asphalt Binder** is hereby deleted and the following substituted therefor:

The asphalt binder for all Asphalt Concrete Hot Mixes shall contain a heat-stable, liquid anti-strip additive. The additive shall be furnished from the Qualified Products List. The additive shall not harm the completed bituminous concrete mixture and must be compatible with the aggregate and asphalt binder supplied for the project. The anti-strip additive shall be added either by an in-line blending process just before introduction of the asphalt binder to the mixer or by blending with the asphalt binder at the asphalt binder terminal. If blended at the terminal, the bill of lading accompanying the load being delivered to the hot mix asphalt plant shall include the anti-strip manufacturer's name, product name, and quantity of all anti-strip additive included in the load.

The liquid anti-strip additive shall be added at rates as indicated below:

- For ACHM mixes where the use of an anti-strip additive is required as determined by the laboratory analysis and mix design procedures, the anti-strip additive shall be added at the rate of 0.5% to 0.75% (0.05% to 0.10% for organosilane based materials) by weight of asphalt binder as determined by the laboratory analysis and laboratory mix design procedures.
- For all other mixes, the manufacturer's recommended dosage of the additive shall be used, but the rate of liquid anti-strip additive shall not be less than 0.25% (0.05% for organosilane based materials) by weight of the asphalt binder.

ARKANSAS DEPARTMENT OF TRANSPORTATION

SUPPLEMENTAL SPECIFICATION

TRACKLESS TACK

Sections 401 and 403 of the Standard Specifications for Highway Construction, Edition of 2014, is hereby amended as follows:

The following is hereby added after the second sentence of **Subsection 401.02 Materials**:

Trackless Tack meeting the requirements of this supplemental specification may be used as Tack Coat at no additional cost to the Department.

The following is hereby added after the fifth sentence of **Subsection 401.03(c), Application of Tack Coat**:

When Trackless Tack is used, the Contractor shall follow the manufacturer's recommendations for storage, application temperature, and application rate.

The following is hereby added as the second paragraph of **Subsection 401.06, Basis of Payment**:

If the Contractor elects to use Trackless Tack in lieu of Tack Coat, the application and payment for the material used will be measured and paid for at the contract unit price bid for Tack Coat per gallon (liter).

The following is hereby added after the second sentence of the first paragraph **Subsection 403.03, Asphalt Materials**:

The manufacturer shall submit certified test results for Trackless Tack to the Engineer.

ARKANSAS DEPARTMENT OF TRANSPORTATION

SUPPLEMENTAL SPECIFICATION

TRACKLESS TACK

The following is hereby added as **Subsection 403.03 (g), Trackless Tack:**

Trackless tack shall be an anionic or cationic asphalt emulsion conforming to the requirements below:

| | Test Method | Min | Max |
|--------------------------------------|-------------|------|-----|
| Viscosity, Saybolt Furol at 25°C SFS | AASHTO T59 | 20 | 150 |
| Storage stability test, 24-h, % | AASHTO T59 | | 1 |
| Sieve test, % | AASHTO T59 | | 0.3 |
| Residue by distillation, % | AASHTO T59 | 50 | |
| Tests on residue from distillation: | | | |
| Penetration, 25°C, 100 g, 5 s | AASHTO T59 | | 20 |
| *Solubility % | AASHTO T44 | 97.5 | |
| *Ash Content | AASHTO T111 | | 1 |
| Softening Point °C | AASHTO T53 | 65 | |

*Ash Content or Solubility may be used for testing purposes of the residue from distillation.

ARKANSAS DEPARTMENT OF TRANSPORTATION

SUPPLEMENTAL SPECIFICATION

DESIGN OF ASPHALT MIXTURES

Section 400 of the Standard Specifications for Highway Construction, Edition of 2014, is hereby amended as follows:

The following is added after the first sentence of paragraph 3 **Subsection 404.01 Design of Asphalt Mixtures. (b) Design Requirements:**

Any use of recycled engine oil bottoms (REOB) or other engine oil derivatives in the manufacture or modification of a binder are strictly prohibited. Ground Tire Rubber (GTR) may be added to asphalt binder with blending of GTR into asphalt occurring only at the asphalt terminal. GTR shall be Class 80-1 ground tire rubber as defined by ASTM D5603.

ARKANSAS DEPARTMENT OF TRANSPORTATION
SUPPLEMENTAL SPECIFICATION
ASPHALT LABORATORY FACILITY

Division 400 of the Standard Specifications for Highway Construction, Edition of 2014, is hereby amended as follows:

Subsection 409.03(h), Plant Inspection, is hereby deleted and the following substituted therefor:

(h) Plant Inspection. The Engineer shall have access to all parts of the plant.

The Contractor shall provide and maintain a laboratory facility for the exclusive use of the Engineer. This facility shall be located at the plant site. The dimensions and other requirements specified herein are minimums. The facility may be built by the Contractor for the specific purposes stated. Portable structures used as lab facilities must be anchored to the ground and have adequate reinforcement to the floor to provide stability for lab equipment. It is not intended, however, to preclude the use of commercially built trailers or prefabricated buildings that may deviate in minor dimension or detail from the requirements listed but may in some features exceed these requirements and in all major respects be entirely suitable for the purpose intended. The Contractor may furnish, in lieu of a separate building, a facility having sufficient space in a building, parts of which are used for other purposes, provided that the facility furnished meets all other requirements of this subsection; is physically separated from the remainder of the building; and has an outside entrance with unrestricted access allowed and reserved for the exclusive use of the Engineer. Adequate space shall be provided for parking of at least three Department vehicles in the vicinity of the facility. The Engineer will determine the suitability of any facility furnished.

General requirements for the laboratory facility are:

- Minimum working laboratory space of 380 square feet (35.3 sq m) for building widths between 8' to 12' (2.4 to 3.7 m) or 208 square feet (19.3 sq m) with a width of 12' (3.7 m) or greater.
- Minimum designated office space of 30 square feet (2.8 sq m) shall be included in addition to the laboratory square footage.
- A ceiling height of 8' (2.4 m) or greater.
- A desk or table approximately 24" x 36" (600 mm x 900 mm), with at least two drawers, each approximately 13" x 13" x 18" (330 mm x 330 mm x 450 mm) for storing records and at least three office style rolling chairs.
- At least one door with a substantial lock and all keys placed in the possession of the Engineer. The door must be a minimum of 36" (900 mm) wide. A second entry door at the end of trailers that are greater than 30' (9.1 m) in length will be required for safety reasons.
- Access to a well-maintained restroom, with a functioning sink, within reasonable proximity to the Department laboratory facility. Portable restrooms are not acceptable.
- Floored, weatherproof, and reasonably dustproof.

ARKANSAS DEPARTMENT OF TRANSPORTATION
SUPPLEMENTAL SPECIFICATION
ASPHALT LABORATORY FACILITY

- Level and stable with substantial/durable structure capable of supporting required laboratory equipment. Movement in the lab shall not affect testing operations such as scale readings, etc.
- At least two glazed screened windows capable of being opened and locked only from the inside.
- Basic utility services shall be provided year-round as long as the plant is listed on the QPL. If utility services to the Department lab are voluntarily suspended at any time, the plant may be removed from the QPL.
- Equip the lab with heating and air conditioning units that maintain the ambient air temperature between 65 °F and 80 °F (18 °C and 27°C). The lab must be climate-controlled year-round.
- A work counter approximately 30" to 36" (760 to 900 mm) high with a minimum depth of 30" (760 mm). The countertop shall be metal capped with a rolled back edge of 2" (50 mm) if adjacent to the wall or other comparable durable surface. Total length of the work counter shall be approximately 35' (10.7 m) with a minimum of 12' (3.7 m) of counter length 36" (900 mm) deep.
- A minimum of 54" (1370 mm) width between parallel work counters.
- Adequate electric lights suitable for the purposes intended. At least one power outlet per every four feet of counter. At least two power outlets shall provide 220 VAC.
- An exhaust outlet with at least 3" (76 mm) inside diameter no farther than 8' (2.4 m) from the ignition oven shall be included near one of the 220 VAC outlets. Provide a surface for the ignition oven that is level, sturdy, and fireproof with at least 6" (152 mm) of clearance between the furnace and other vertical surfaces. The exhaust fumes exiting the furnace exhaust port may reach 270 °C (518 °F).
- An exhaust fan shall be installed over the equipment clean up area. The exhaust fan shall be equipped with a rheostat control and capable of exhausting in one minute a volume of air equal to the volume of the entire laboratory. The exhaust fan shall be maintained operational.
- A sink, approximately 25" (635 mm) square with a minimum depth of 9" (230 mm) with an outside drain.
- A clean water supply providing a minimum of 50 gallons (200 liters) storage capacity (or connected to a public or private water system), discharging through a faucet above the sink. A thermostat controlled hot water supply shall be provided to the laboratory sink.
- Adequate shelves and/or cabinets for storage of testing equipment that do not impede the operation of testing equipment.
- A storage area for storing nuclear equipment, complete with a substantial lock and all keys to this area placed in the possession of the Engineer.
- At least one Type ABC fire extinguisher (10-pound size minimum) with up-to-date inspection tag per 300 square feet of building.

ARKANSAS DEPARTMENT OF TRANSPORTATION
SUPPLEMENTAL SPECIFICATION
ASPHALT LABORATORY FACILITY

- A local access touchtone telephone line (with access to toll free telephone numbers but otherwise blocked for outgoing long-distance calls), with a landline modular jack and touchtone telephone, shall be provided in the laboratory facility for use by Department personnel.
- Reliable Broadband Internet Service shall be provided.
The Broadband Internet Service shall be provided with an Internet Protocol (IP) address which is reachable on the global Internet (public) and which is permanently assigned (static). The Contractor is not required to provide this service if an IP address which is both static and public is not available.

If this service is not available at the beginning of a project but becomes available during the life of the project, the Contractor shall provide the service immediately from the date of availability.

The data transfer rate shall be 3 megabits per second (Mbps) download and 500 kilobits per second (kbps) upload, or higher, with latency not to exceed 150 milliseconds. If the Broadband Internet Service meets all of the requirements of this specification except for the data transfer rate and/or latency, then the best performing available connection shall be provided. The Broadband Internet Service shall be provided with equipment providing a minimum of one Ethernet port.

Prior to the selection of the Broadband Internet Service provider, the Contractor shall submit to the Resident Engineer, in writing, the proposed method for providing Broadband Internet Service. The Resident Engineer shall review this submittal and respond in writing regarding the acceptability of the proposed method.

Adequate maintenance of the laboratory facility shall be required for plant inclusion on the QPL and will be included as part of the annual ACHM plant inspection. Maintenance shall include, but is not limited to, HVAC and electrical systems, and plumbing. The Resident Engineer may determine a lab is in reasonable compliance with this specification if all required testing can be accomplished with reasonable ease by the Construction Materials Inspector.

The requirements of this Supplemental Specification shall be implemented in order to receive the next scheduled ACHM Plant Certification. If the requirements are not met and the Resident Engineer determines the laboratory is not within reasonable compliance an ACHM Plant Certification will not be provided until all requirements are fulfilled and/or the Resident Engineer is satisfied with the conditions of the facilities.

The field laboratory for asphalt mixing plants and the utility services provided will not be paid for directly but will be considered a part of the asphalt mixing plant.

ARKANSAS DEPARTMENT OF TRANSPORTATION

SUPPLEMENTAL SPECIFICATION

**CONSTRUCTION REQUIREMENTS AND ACCEPTANCE OF
ASPHALT CONCRETE PLANT MIX COURSES**

Section 410, Construction Requirements and Acceptance of Asphalt Concrete Plant Mix Courses, of the Standard Specifications for Highway Construction, Edition of 2014, is hereby modified as follows:

Subsection 410.10 Incentives is hereby deleted.

ARKANSAS DEPARTMENT OF TRANSPORTATION

SUPPLEMENTAL SPECIFICATION

DEVICES FOR MEASURING DENSITY FOR ROLLING PATTERNS

Section 410 of the Standard Specifications for Highway Construction, Edition of 2014, is hereby amended as follows:

The fourth sentence of the first paragraph of **Subsection 410.08, Rolling and Density Requirements and Joints**, is hereby deleted and the following substituted therefor:

The Engineer will observe the Contractor's use of an electromagnetic surface contact device that meets ASTM D7113/D7113M or the use of a nuclear density gauge to verify that the maximum densities possible are obtained.

ARKANSAS DEPARTMENT OF TRANSPORTATION

SUPPLEMENTAL SPECIFICATION

EVALUATION OF ACHM SUBLLOT REPLACEMENT MATERIAL

Section 410 of the Standard Specifications for Highway Construction, Edition of 2014, is hereby amended as follows:

The following shall be added to the second to the last paragraph of **Subsection 410.09 (a)**

General:

If the material used to replace unacceptable material is a different mix design from what was originally placed, the remaining material in the lot and the replacement material shall both be evaluated as separate partial lots.

ARKANSAS DEPARTMENT OF TRANSPORTATION
SUPPLEMENTAL SPECIFICATION
RECYCLED ASPHALT PAVEMENT

Division 400 of the Standard Specifications for Highway Construction, Edition of 2014, is hereby amended as follows:

The fourth paragraph of **Subsection 416.03, Materials and Composition**, is hereby deleted and the following substituted therefor:

To ensure the “production” stockpile is distinguishable to anyone involved in the production of asphalt at the plant and no “unprocessed” materials are introduced into the process of ACHM mix manufacturing, the following shall be required for the use of Recycled Asphalt Pavement (RAP):

- RAP stockpiles should have only binder covered aggregates and therefore, there shall be no virgin aggregate or deleterious materials present in any RAP stockpile. Uncoated aggregate from asphalt plant produced material shall not be considered virgin aggregate as it applies to RAP. Plant startup and shut down materials will be considered binder covered and are allowed.
- Unprocessed RAP and processed RAP stockpiles shall be separated by distance and each stockpile signed accordingly.
- Only processed RAP shall be introduced into asphalt mixes. Processed is defined as efforts to create a uniform stockpile of material and may include, but is not limited to, crushing and/or fractionating. Use of the scalper screen on the plant does not define processed RAP.
- Processed RAP stockpiles shall be of adequate size for multiple operational days of asphalt mix production at the plant’s maximum production rate. Processed RAP must be stockpiled before use in plant production. Processed RAP may not be taken from underneath the crusher and placed directly into the cold feed bins. If the crusher is feeding the processed stockpile, the loader must load the cold feed bins from the opposite end of the processed stockpile.

Quality control testing for asphalt binder content and gradation of RAP shall be the contractor’s responsibility and conducted as follows:

- Tested as part of the field verification process. Field verification test results may be transferred from another ARDOT job given they are from the same mix design and were completed within 120 days of the current job’s field verification process.
- Minimum of one set of tests per job for jobs that contain at least 1,000 tons of ACHM.
- One set of tests for every 10,000 tons of ACHM produced.
- The first tests on the job must be performed within the first 3 days of production on the job.

ARKANSAS DEPARTMENT OF TRANSPORTATION
SUPPLEMENTAL SPECIFICATION
RECYCLED ASPHALT PAVEMENT

The Contractor has the option of quality control testing while the processed stockpile is being built in lieu of testing during production. Quality control testing for asphalt binder content and gradation of RAP shall be the Contractor's responsibility and conducted as follows:

- Tested as part of the field verification process. Field verification test results may be transferred from another ARDOT job given they are from the same mix design and were completed within 120 days of the current job's field verification process.
- One set of tests for every 1,500 tons of RAP produced for each stockpile.
- The quantity of RAP being placed in the processed stockpile must be tracked.

The Contractor shall pick only one option of quality control method per processed RAP stockpile. The Engineer shall be given the opportunity to witness all testing. Test results shall be submitted to the Engineer by the next business day. The Contractor shall keep a logbook to track the consistency of the asphalt binder content and gradation.

If testing determines the properties of the RAP have deviated significantly from the mix design, as determined by the Engineer, changes to virgin binder content and/or aggregate proportions will be required before production of the ACHM continues. Once adjustments are made and the plant produced mix has the desired properties, the Contractor may request that a field mix design be accepted by the Engineer.

To create uniform, repeatable testing for RAP binder content, asphalt binder content of the RAP shall be determined using AASHTO T 308 with the specific requirements as follows:

- Sample shall be dried to a constant mass as per AASHTO T 329 using a drying temperature of $230\text{ }^{\circ}\text{F} \pm 9\text{ }^{\circ}\text{F}$.
- The ignition oven burn temperature used during the mix design process must be used for quality control. The burn temperature shall be reported on the mix design submittal.
- Asphalt Binder Content = % loss – Aggregate Correction Factor (ACF)
- An ACF for each processed RAP stockpile shall be submitted with the mix design if used. An ACF for the job mix formula shall be submitted on the mix design if used. If multiple ignition ovens are used, an ACF for each oven shall be submitted.
- Determination of the ACF may be based on regional historical data at the time of the change. This will ensure all parties involved are aware of the correction factor and therefore avoiding disagreements pertaining to manipulation/fluctuation in aggregate correction factors that could be used to adjust binder content data.

ARKANSAS DEPARTMENT OF TRANSPORTATION
SUPPLEMENTAL SPECIFICATION
RETROREFLECTIVE SHEETING FOR
TRAFFIC CONTROL DEVICES IN CONSTRUCTION ZONES

Section 604 of the Standard Specifications for Highway Construction, Edition of 2014, is hereby amended as follows:

The following is inserted after the first paragraph of Subsection 604.02(b):

Retroreflective sheeting used on traffic drums shall meet the requirements of ASTM D4956 for Type III or IV with the additional requirements for Reboundable Sheeting. Retroreflective sheeting for delineators shall comply with section 728.

Retroreflective sheeting shall be applied to a properly treated substrate with mechanical equipment and in a manner specified by the sheeting manufacturer. Sign material (substrate) shall be of sufficient thickness and stability to maintain a substantial, effective sign for the duration of the project. One splice will be allowed in retroreflective sheeting on sign blanks. "Left", "Right", "Distances", and "Ahead" will be allowed on signs as inserts. All letters and numerals on inserts shall be of the same size and series as those on the sign face.

ARKANSAS DEPARTMENT OF TRANSPORTATION

SUPPLEMENTAL SPECIFICATION

TRAFFIC CONTROL DEVICES IN CONSTRUCTION ZONES (MASH)

Section 604 of the Standard Specifications for Highway Construction, Edition of 2014, is hereby amended as follows:

The first paragraph of **Subsection 604.02 Materials (a) General** is hereby deleted and the following substituted therefor:

All work zone traffic control devices used on the project, including sign supports, barricades, traffic drums equipped with flashing lights, crash cushions, and impact attenuators, manufactured after December 31, 2019, shall comply with the requirements of the Manual for Assessing Safety Hardware (MASH). Such devices manufactured on or before December 31, 2019, and successfully tested to the requirements of National Cooperative Highway Research Program (NCHRP) Report 350 or the 2009 edition of MASH, may continue to be used throughout their normal service lives. The Contractor shall furnish a certification of such compliance from the manufacturer or supplier of all work zone traffic control devices prior to using the devices on the project. The certification shall state the device meets the requirements of MASH, or in the case that the device was manufactured on or before December 31, 2019, the certification shall state the device meets the requirements of NCHRP 350 or MASH. The certification shall include a copy of the Federal Highway Administration's (FHWA) approval letter with all attachments for each device. Devices shall be fabricated and installed in accordance with the plans and with the crash testing documentation provided in the FHWA approval letter which is available at:

http://safety.fhwa.dot.gov/roadway_dept/policy_guide/road_hardware/.

ARKANSAS DEPARTMENT OF TRANSPORTATION**SUPPLEMENTAL SPECIFICATION****GENERAL REQUIREMENTS FOR SIGNS**

Section 723 of the Standard Specifications for Highway Construction, Edition of 2014, is hereby amended as follows:

Subsection 723.02(b) is hereby deleted and the following is substituted therefor:

(b) Sign Panels. Standard signs shall consist of a single sheet of aluminum alloy (ASTM B 209, Alloy 5052 H38) without stiffeners on the back. Minimum sign blank thickness shall be 0.080" (2.0 mm) for a sign size of 9 square feet (0.84 sq m) or less or 0.100" (2.5 mm) for a sign size greater than 9 square feet (0.84 sq m). Sign blanks shall be flat and straight and within commercial tolerances established by the aluminum industry.

Guide signs shall be fabricated using one piece extruded panels fabricated of aluminum alloy (ASTM B221, Alloy 6063 T6).

Extruded panel signs shall consist of sign panels; stringers or horizontal supporting members; necessary fasteners for assembling the units; reflective materials; letters; numerals; symbols; and border. All extrusions and fasteners shall be applied without causing objectionable projections on the sign face.

The one piece extruded aluminum panels shall be a minimum of 12" (300 mm) in width except one 6" (150 mm) panel may be used per sign face when necessary to construct the sign as shown on the plans.

All extruded panels shall be bolted together at every other hole (every 24" [610 mm]) with the faces and ends in alignment.

Single sheet and extruded panels to which reflective sheeting is to be applied shall be conversion coated as specified in ASTM B449 or ASTM B921 per the sheeting manufacturer's recommendations.

All fabrication, including cutting and punching of holes, excluding holes for demountable letters, numerals, symbols, and borders, shall be completed before conversion coating.

Sign panels shall be free of buckles, warp, dents, cockles, burrs, and defects resulting from fabrication. The surface of all sign panels shall be flat.

The Contractor shall submit a Certified Test Report to the Engineer covering the sign panels.

The first paragraph of **Subsection 723.02(c)** is hereby deleted and the following is substituted therefor:

ARKANSAS DEPARTMENT OF TRANSPORTATION**SUPPLEMENTAL SPECIFICATION****GENERAL REQUIREMENTS FOR SIGNS**

(c) Retroreflective Sheeting. The retroreflective sheeting for signs shall comply with ASTM D4956 for Type III, IV, VIII, or IX retroreflective sheeting, except that Type IX retroreflective sheeting shall be used on all W1-6, W1-8, and OM-3 signs. ASTM D4956 Type XI sheeting shall be used on all R5-1 and R5-1a signs. All retroreflective sheeting shall have either Class 1 or Class 2 backing.

Subsection 723.02(d) is hereby deleted and the following is substituted therefor:

(d) Legend. All legend, which includes letters, numerals, symbols, arrows, and border, shall have a regular outline, be clean cut and sharp, and shall have a continuous stroke and border without ragged or torn edges.

All legend on guide signs shall be of the size shown on the plans. Legend on standard signs shall comply with the latest revision of FHWA Standard Highway Signs.

The legend on freeway main lane guide signs shall be demountable. Unless otherwise specified, the legend on all other guide signs shall be manufactured using either direct application or acrylic overlay film. All other signs shall be manufactured using standard industry processes, including silk screening, acrylic overlay film, and digital printing. Digitally printed signs shall be overlaid with a clear UV film per the sheeting manufacturer's recommendation.

All demountable legend shall be of the same manufacturer. The sign area outside the corner radius shall not be trimmed to match the border radius.

Frames for border strips, corners, shields, and legend shall be fabricated from 0.063" (1.6 mm) sheet aluminum complying with the requirements of ASTM B209, Alloy 5052-H38. Mounting holes shall be provided with the frames to permit the use of screws, bolts, rivets, or other fasteners of stainless steel, galvanized steel, or aluminum to fasten the frames to the sign face, subject to the condition that dissimilar metals shall be insulated to prevent corrosion.

The aluminum frames shall comply with Subsection 723.02(b).

All border material shall be secured from the same company that furnishes the cutout letters, numerals, etc. and shall be mounted in the same manner as the cutout letters.

Transparent colors, inks, paints, and films used in the sign manufacturing process shall be of the type and quality recommended by the manufacturer of the reflective sheeting and shall conform to red, blue, yellow, and green colors approved by the FHWA and shown in the MUTCD and FHWA Standard Highway Signs. The Contractor shall provide a sheeting manufacturer's full component system warranty, and shall provide certification that the materials used shall meet all MUTCD minimum requirements for retroreflectivity and contrast for the warranty period of the sheeting.

ARKANSAS DEPARTMENT OF TRANSPORTATION**SUPPLEMENTAL SPECIFICATION****CHANNEL POST SIGN SUPPORT**

Section 729 of the Standard Specifications for Highway Construction, Edition of 2014, is hereby amended as follows:

The following paragraph is added after the last paragraph of **Subsection 729.02 Materials**:

All posts used on the project, manufactured after December 31, 2019, shall comply with the requirements of the Manual for Assessing Safety Hardware (MASH). Such devices manufactured on or before December 31, 2019, and successfully tested to the requirements of National Cooperative Highway Research Program (NCHRP) Report 350 or the 2009 edition of MASH, may continue to be used throughout their normal service lives. The Contractor shall furnish a certification of such compliance from the manufacturer or supplier of all posts prior to using the devices on the project. The certification shall state the post meets the requirements of MASH, or in the case that the post was manufactured on or before December 31, 2019, the certification shall state the post meets the requirements of NCHRP 350 or MASH. The certification shall include a copy of the Federal Highway Administration's (FHWA) approval letter with all attachments for each device. Devices shall be fabricated and installed in accordance with the plans and with the crash testing documentation provided in the FHWA approval letter, which is available at:

http://safety.fhwa.dot.gov/roadway_dept/policy_guide/road_hardware/.

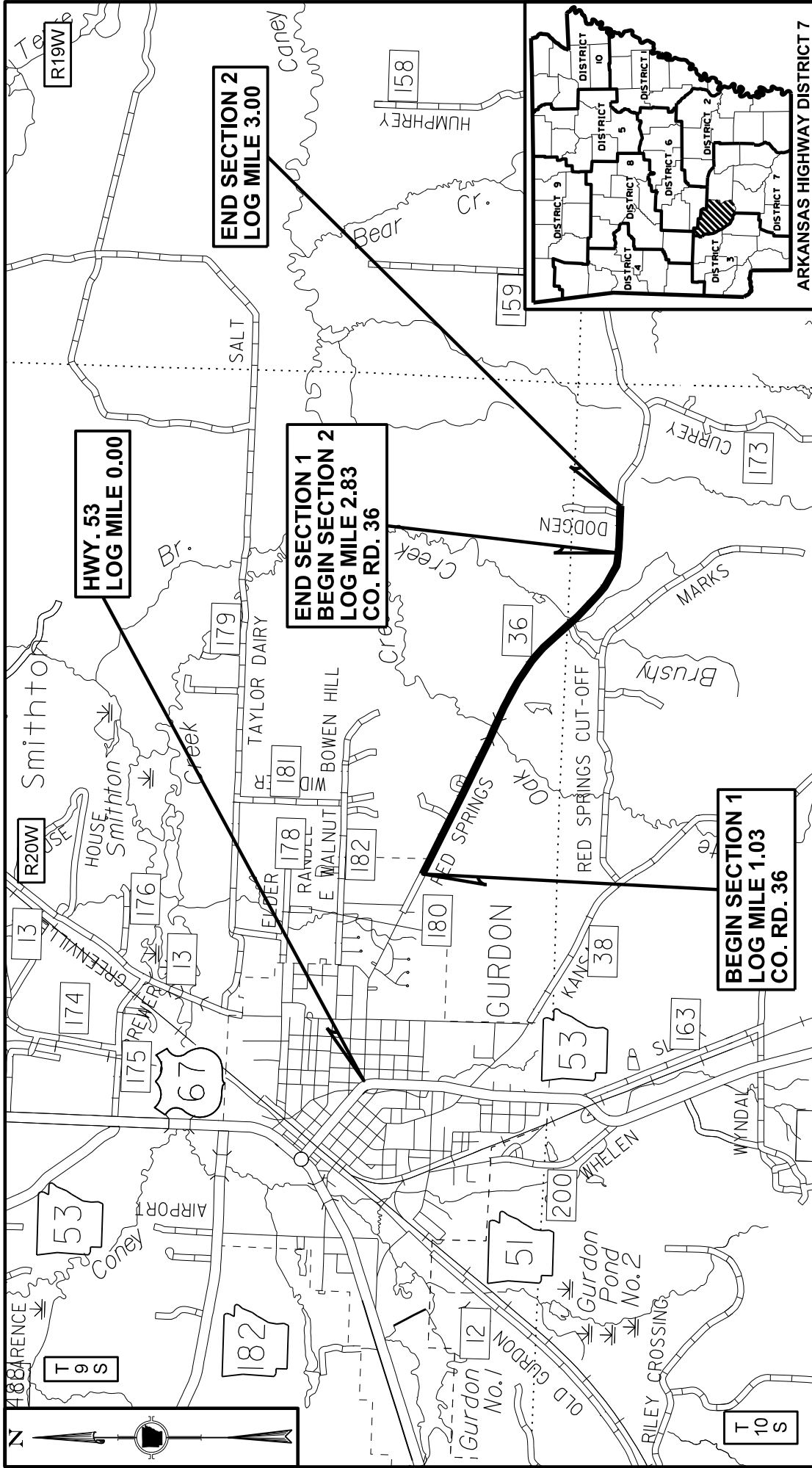

JOB SA1066

CO. RD. 36 OVERLAY (S)

CO. RD. 36

CLARK COUNTY

Digitally signed by
 Freeling, Bryan E.
 Date: 2024.03.21
 15:45:54-05'00'



APPROXIMATE CENTER OF SECTION 1
 LATITUDE: N 33° 54' 33"
 LONGITUDE: W 93° 07' 18"

INDEX OF SHEETS

TITLE

SHEET NO.

- 1 _____ TITLE SHEET
- 2 _____ INDEX OF SHEETS AND STANDARD DRAWINGS
- 3 - 4 _____ GOVERNING SPECIFICATIONS
- 5 _____ GENERAL NOTES
- 6 - 7 _____ TYPICAL SECTIONS OF IMPROVEMENT
- 8 _____ SPECIAL DETAILS
- 9 - 12 _____ QUANTITIES
- 13 _____ SUMMARY OF QUANTITIES AND REVISIONS

ROADWAY STANDARD DRAWINGS

TITLE

DRWG. NO.

| DRWG. NO. | TITLE | DATE |
|-----------|--|----------|
| PM-1 | PAVEMENT MARKING DETAILS | 02-27-20 |
| SHS-1 | STANDARD HIGHWAY SIGNS AND SUPPORT ASSEMBLIES | 09-12-13 |
| SHS-2 | U-CHANNEL POST ASSEMBLIES | 07-25-19 |
| TC-1 | STANDARD TRAFFIC CONTROLS FOR HIGHWAY CONSTRUCTION | 11-07-19 |
| TC-2 | STANDARD TRAFFIC CONTROLS FOR HIGHWAY CONSTRUCTION | 05-20-21 |
| TC-3 | STANDARD TRAFFIC CONTROLS FOR HIGHWAY CONSTRUCTION | 08-12-21 |

GOVERNING SPECIFICATIONS (SHEET 1 OF 2)

ARKANSAS STATE HIGHWAY COMMISSION STANDARD SPECIFICATIONS FOR HIGHWAY CONSTRUCTION,
EDITION OF 2014, AND THE FOLLOWING SPECIAL PROVISIONS AND SUPPLEMENTAL SPECIFICATIONS.

| NUMBER | TITLE |
|--------|--|
| ERRATA | ERRATA FOR THE BOOK OF STANDARD SPECIFICATIONS |
| 100-3 | CONTRACTOR'S LICENSE |
| 100-4 | DEPARTMENT NAME CHANGE |
| 102-2 | ISSUANCE OF PROPOSALS |
| 103-2 | CONTACT INFORMATION FOR MOTORIST DAMAGE CLAIMS |
| 105-4 | MAINTENANCE DURING CONSTRUCTION |
| 107-2 | RESTRAINING CONDITIONS |
| 108-1 | LIQUIDATED DAMAGES |
| 108-2 | WORK ALLOWED PRIOR TO ISSUANCE OF WORK ORDER |
| 108-3 | WORK ORDER FOR FIXED COMPLETION DATE CONTRACTS |
| 303-1 | AGGREGATE BASE COURSE |
| 306-1 | QUALITY CONTROL AND ACCEPTANCE |
| 400-1 | TACK COATS |
| 400-4 | DESIGN AND QUALITY CONTROL OF ASPHALT MIXTURES |
| 400-5 | PERCENT AIR VOIDS FOR ACHM MIX DESIGNS |
| 400-6 | LIQUID ANTI-STRIP ADDITIVE |
| 400-7 | TRACKLESS TACK |
| 404-3 | DESIGN OF ASPHALT MIXTURES |
| 409-2 | ASPHALT LABORATORY FACILITY |
| 410-1 | CONSTRUCTION REQUIREMENTS AND ACCEPTANCE OF ASPHALT CONCRETE PLANT MIX COURSES |
| 410-2 | DEVICES FOR MEASURING DENSITY FOR ROLLING PATTERNS |
| 410-4 | EVALUATION OF ACHM SUBLOT REPLACEMENT MATERIAL |
| 416-1 | RECYCLED ASPHALT PAVEMENT |
| 604-1 | RETROREFLECTIVE SHEETING FOR TRAFFIC CONTROL DEVICES IN CONSTRUCTION ZONES |
| 604-3 | TRAFFIC CONTROL DEVICES IN CONSTRUCTION ZONES (MASH) |
| 723-1 | GENERAL REQUIREMENTS FOR SIGNS |
| 729-1 | CHANNEL POST SIGN SUPPORT |

GOVERNING SPECIFICATIONS (SHEET 2 OF 2)

ARKANSAS STATE HIGHWAY COMMISSION STANDARD SPECIFICATIONS FOR HIGHWAY CONSTRUCTION,
EDITION OF 2014, AND THE FOLLOWING SPECIAL PROVISIONS AND SUPPLEMENTAL SPECIFICATIONS.

| NUMBER | TITLE |
|------------|--|
| JOB SA1066 | BIDDING REQUIREMENTS AND CONDITIONS |
| JOB SA1066 | BROADBAND INTERNET SERVICE FOR ASPHALT CONCRETE PLANT |
| JOB SA1066 | DESIGN AND QUALITY CONTROL OF ASPHALT MIXTURES |
| JOB SA1066 | LIQUIDATED DAMAGES PROCEDURE FOR BID LETTINGS |
| JOB SA1066 | MANDATORY ELECTRONIC CONTRACT |
| JOB SA1066 | MANDATORY ELECTRONIC DOCUMENT SUBMITTAL |
| JOB SA1066 | PERCENT AIR VOIDS AND NDESIGN FOR ACHM SURFACE MIX DESIGNS |
| JOB SA1066 | PRICE ADJUSTMENT FOR ASPHALT BINDER |
| JOB SA1066 | PRICE ADJUSTMENT FOR FUEL |
| JOB SA1066 | RECYCLED ASPHALT SHINGLES |
| JOB SA1066 | SUBMISSION OF ASPHALT CONCRETE HOT MIX ACCEPTANCE TEST RESULTS |
| JOB SA1066 | WARM MIX ASPHALT |

GENERAL NOTES

1. THE SEQUENCE AS SHOWN ON THE MAINTENANCE OF TRAFFIC PLANS IS A GENERAL OUTLINE FOR THE CONSTRUCTION OF THIS PROJECT, AND IN NO WAY IS IT INTENDED TO COVER EVERY ITEM IN THE PROJECT. ITEMS NOT CRITICAL TO THE CONSTRUCTION SEQUENCE MAY BE CONSTRUCTED IN ANY STAGE AS APPROVED BY THE RESIDENT ENGINEER.
2. THE CONTRACTOR SHALL CLIP GRASS AND DEBRIS FROM THE EDGE OF THE EXISTING ROADWAY. THESE "CLIPPINGS" SHALL BE PULLED UP TO THE EDGE OF THE NEW PAVEMENT IN SECTIONS WHERE THE SHOULDERS ARE NOT BEING REBUILT WITH AGGREGATE OR BORROW. NO DIRECT PAYMENT WILL BE MADE FOR THIS WORK.
3. INSTALLATION OF PERMANENT TRAFFIC SAFETY SIGNS NOT SHOWN IN THE PLANS IS THE RESPONSIBILITY OF CLARK COUNTY.

NOTE: DETAILS MAY BE MODIFIED TO MEET LOCAL CONDITIONS AS DIRECTED BY THE ENGINEER.

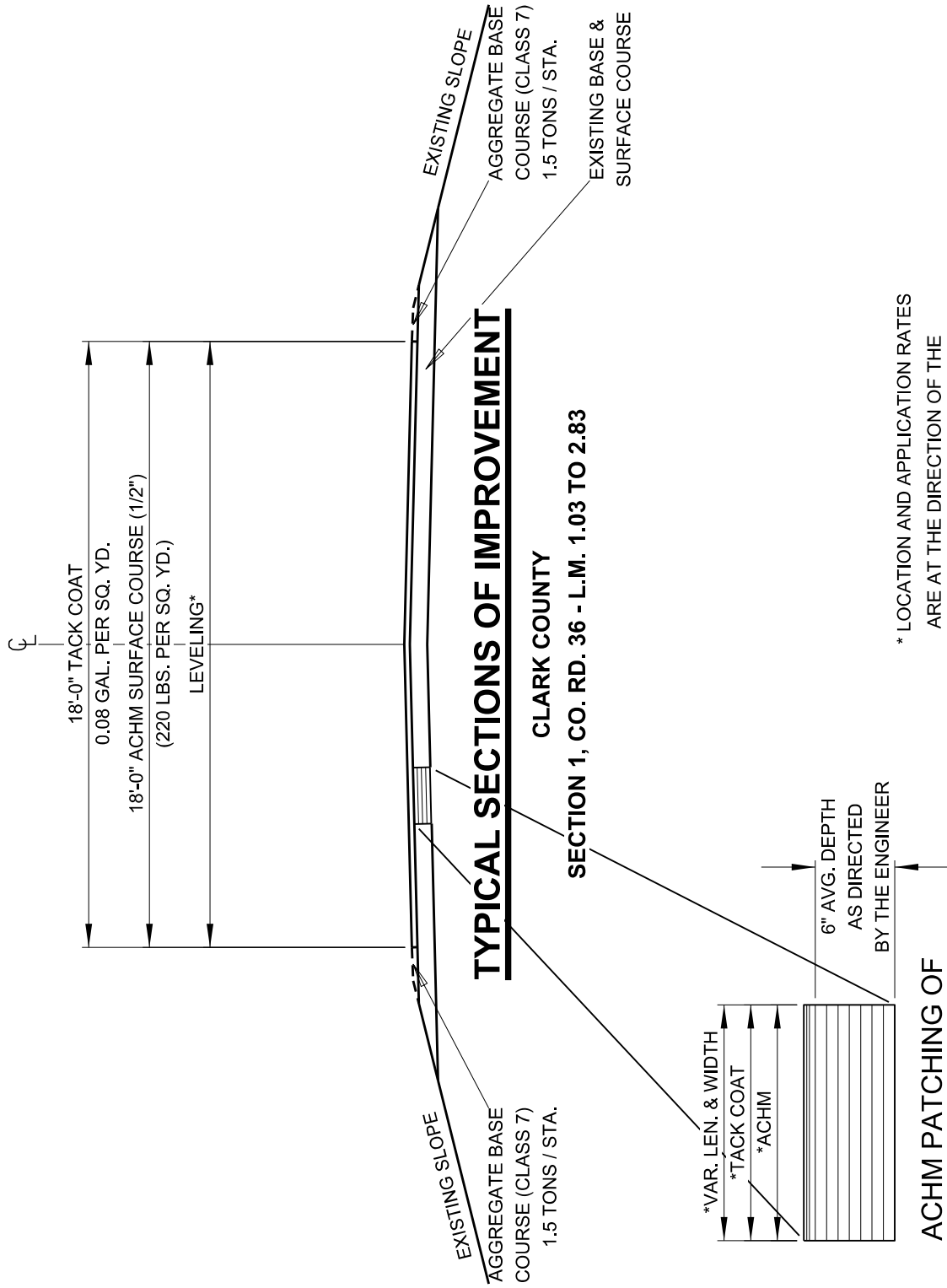

* LOCATION AND APPLICATION RATES ARE AT THE DIRECTION OF THE ENGINEER. SEE QUANTITY SHEET FOR ESTIMATED AMOUNTS.

ACHM PATCHING OF EXISTING ROADWAY
PAY ITEMS AND CONSTRUCTION REQUIREMENTS ARE AS DEFINED IN SECTION 415 OF THE STANDARD SPECIFICATIONS FOR HIGHWAY CONSTRUCTION.

NOTE: DETAILS MAY BE MODIFIED TO MEET LOCAL CONDITIONS AS DIRECTED BY THE ENGINEER.

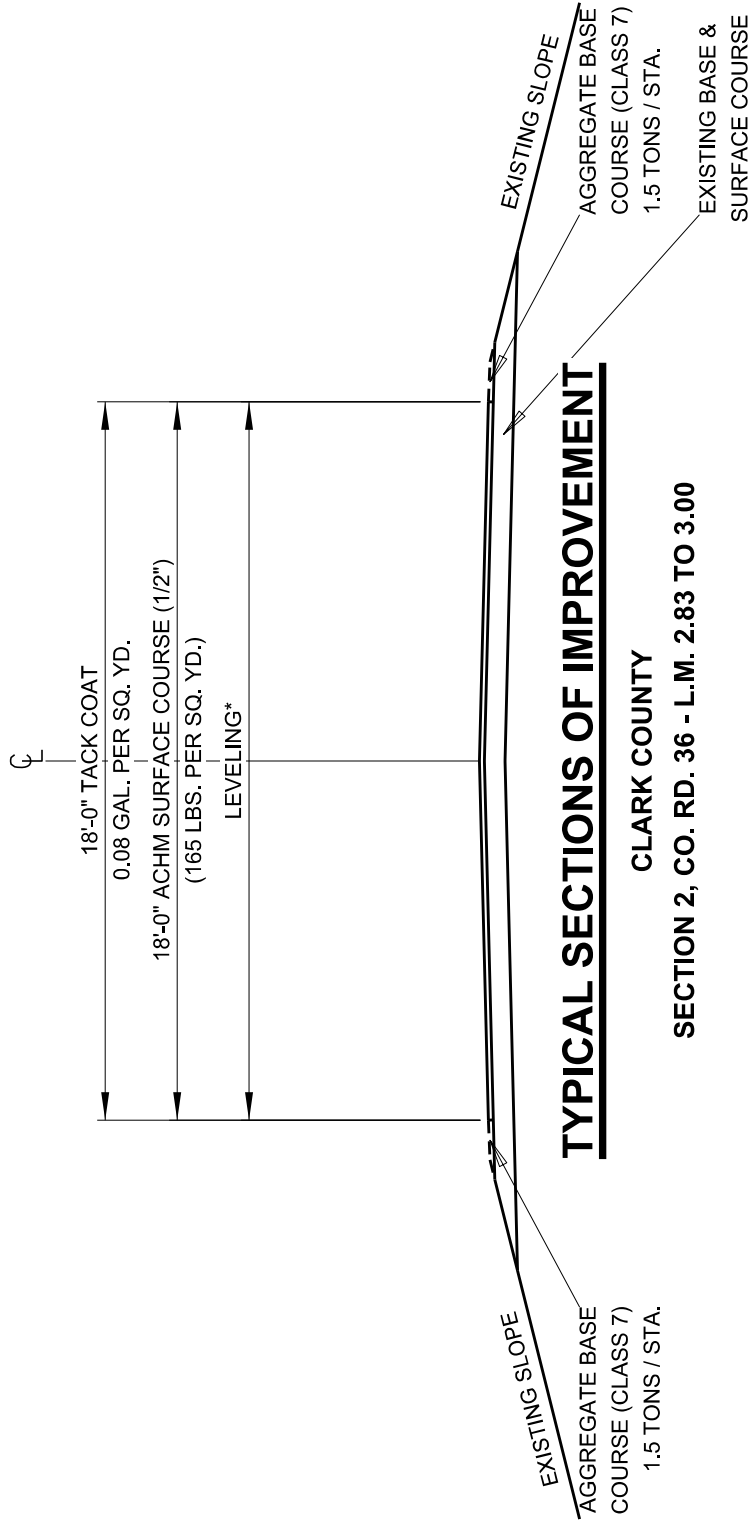

* LOCATION AND APPLICATION RATES ARE AT THE DIRECTION OF THE ENGINEER. SEE QUANTITY SHEET FOR ESTIMATED AMOUNTS.

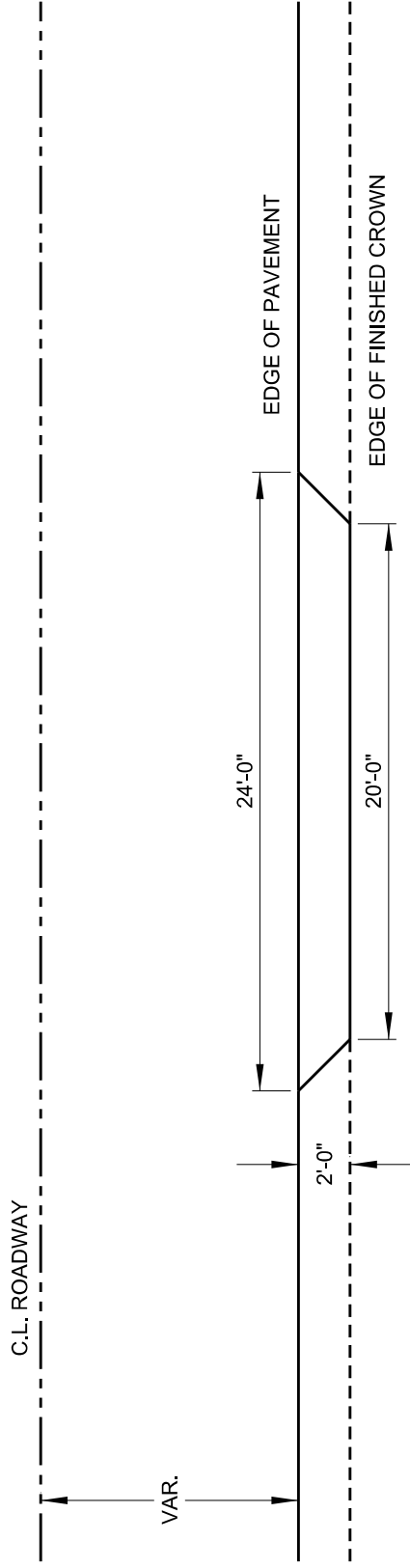

TYPICAL PRIVATE ENTRANCE
ADDITIONAL SURFACING AREA = 4.9 SQ. YDS.

NOTE: DIMENSIONS MAY BE MODIFIED TO MEET
 LOCAL CONDITIONS AS DIRECTED BY THE ENGINEER.

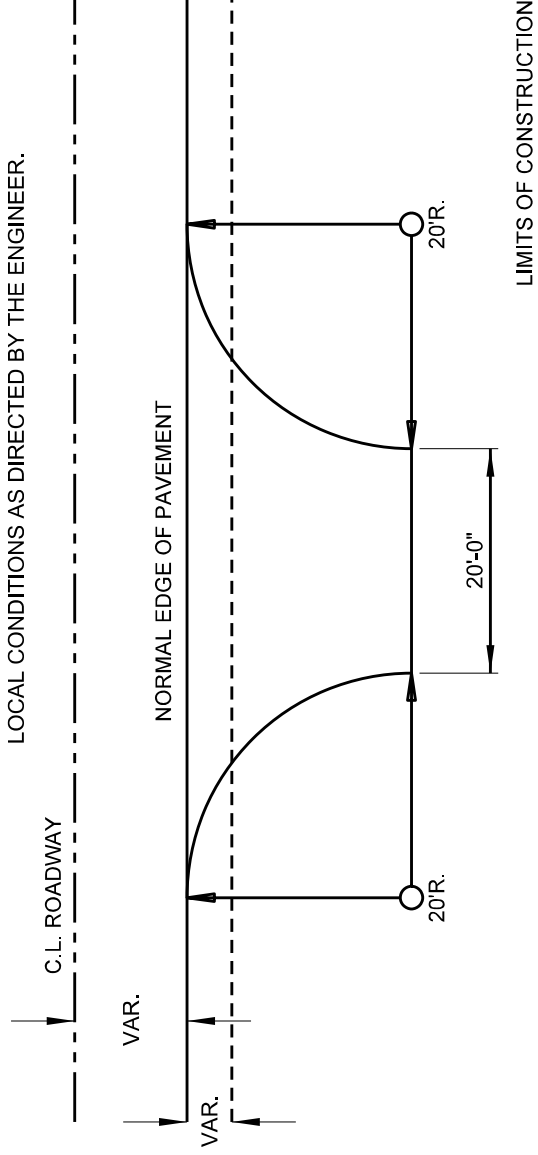

TYPICAL COUNTY TURNOUT
ADDITIONAL SURFACING AREA = 63.5 SQ. YDS.

- NOTES:
- REFER TO THE STRIPING DETAILS FOR PAVEMENT MARKING LINE WIDTHS.
 - THIS DRAWING SHALL BE USED IN CONJUNCTION WITH THE LATEST REVISED ADDITION OF THE "MANUAL ON UNIFORM TRAFFIC CONTROL DEVICES."
 - RAISED PAVEMENT MARKERS SHALL BE PLACED ON AN 80 FEET SPACING UNLESS OTHERWISE SHOWN IN THE PLANS.

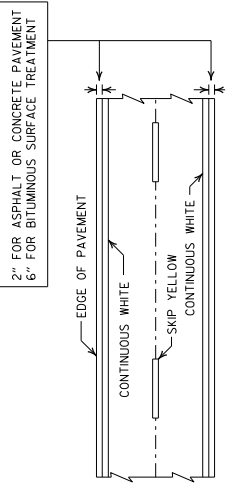

PAVEMENT EDGE LINE MARKING

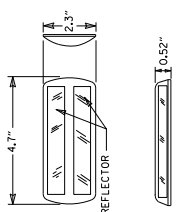

NOTE: THE RED LENS OF THE TYPE II R.P.M. SHALL BE PLACED TO THE RIGHT OF TRAFFIC MOVEMENT.

NOTE: DIMENSIONS SHOWN FOR RAISED PAVEMENT MARKERS ARE MINIMUMS. CONTRACTOR MAY SUBSTITUTE SIMILAR MARKERS WITH THE APPROVAL OF THE ENGINEER, REQUESTING APPROVAL FOR SIMILAR MARKERS MAY BE MADE BY REFERRING TO THE ARIOT QUALIFIED PRODUCTS LIST.

DETAIL OF STANDARD RAISED PAVEMENT MARKERS

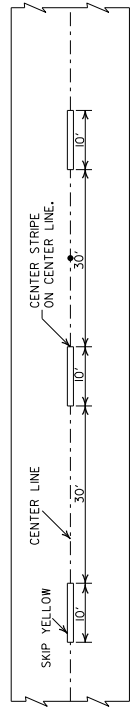

ASPHALT PAVEMENT

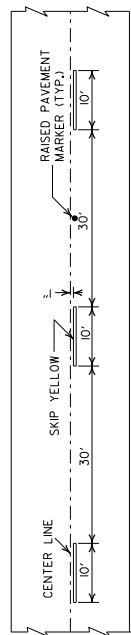

CONCRETE PAVEMENT

BROKEN LINE STRIPING

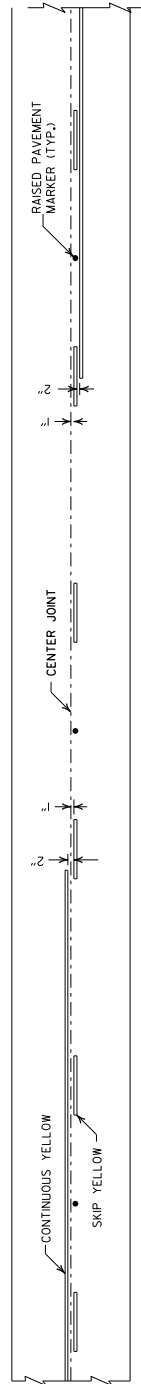

SOLID LINE STRIPING ON CONCRETE PAVEMENT

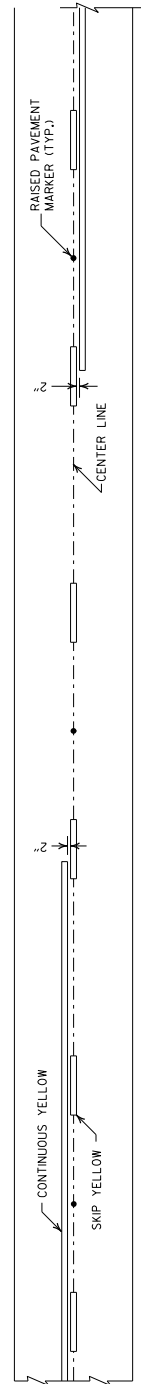

SOLID LINE STRIPING ON ASPHALT PAVEMENT

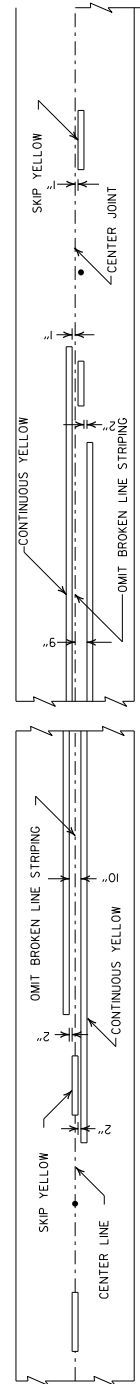

CONCRETE PAVEMENT

STRIPING AT ADJACENT NO PASSING LANES

12" STOP LINE OFFSET FROM CROSSWALK FROM CROSSWALK 4' FROM CENTER LINE OF CROSSWALK

12" CROSSWALK STRIPES OFFSET FROM EDGE OF CROSSWALK 4" O.C. 3 FT. MIN. FROM LANE EDGE

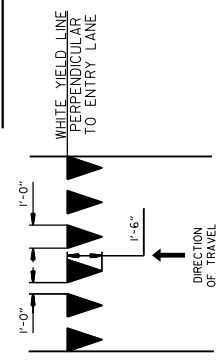

YIELD LINE DETAIL

CROSSWALK AND STOP LINE DETAILS

| DATE | REVISION |
|-----------|--|
| 2-27-20 | REVISED STOP LINE DETAILS |
| 6-21-16 | ADDED 2' TO LINE WIDTH |
| 5-21-16 | REVISED LINE WIDTHS, SPACING, & NOTES |
| 9-12-16 | REVISED DETAIL OF STANDARD RAISED PAVEMENT MARKERS |
| 11-17-10 | REVISED GENERAL NOTES & REMOVED PLOWABLE PAVT MKRS |
| 11-8-04 | REVISED NOTE 2 & GENERAL NOTES |
| 8-22-02 | ADDED CROSSWALK & STOPBAR DTLS. |
| 7-02-98 | ADDED DETAIL OF STD. RAISED PAVT. MARKERS. |
| 5-30-80 | REV. NOTES 3&4, ADDED R.P.M. |
| 1-5-30-80 | FILED |

ARKANSAS STATE HIGHWAY COMMISSION

PAVEMENT MARKING DETAILS

STANDARD DRAWING PM-1

| | | | | | | | | | | | | | | | | | | | |
|---|---|--|----------------------------------|--|----------------------------------|--|----------------------------------|--|------------------|--|------------------|--|------------------|--|------------------|--|------------------|--|------------------|
| | RI-1 30"x30" | | RI-2 36"x36"x36" | | RI-3 30"x30" (L.T. OR RT.) | | W1-8 18"x24" | | W2-5 30"x30" | | W3-1 36"x36" | | W5-1 36"x36" | | M6-3 21"x45" | | M6-3 21"x45" | | M6-3 21"x45" |
| | RI-2 36"x36"x36" | | W2-1 30"x30" | | W2-2 30"x30" | | W2-3 30"x30" (L.T. OR RT.) | | W2-4 30"x30" | | W2-5 36"x36" | | W5-2 36"x36" | | W5-3 36"x36" | | W5-3 36"x36" | | W5-3 36"x36" |
| | RI-5 30"x30" (L.T. OR RT.) | | W1-4 30"x30" (L.T. OR RT.) | | W1-5 30"x30" (L.T. OR RT.) | | W1-6 48"x24" | | W1-7 48"x24" | | W1-8 48"x24" | | W1-9 48"x24" | | W1-10 48"x24" | | W1-11 48"x24" | | W1-12 48"x24" |
| | W5-2 36"x36" | | W5-3 36"x36" | | W5-3 36"x36" | | W5-3 36"x36" | | W5-3 36"x36" | | W5-3 36"x36" | | W5-3 36"x36" | | W5-3 36"x36" | | W5-3 36"x36" | | W5-3 36"x36" |
| | W3-1P 18"x18" | | W3-2 36"x36" | | W3-3 36"x36" | | W3-4 36"x36" | | W3-5 36"x36" | | W3-6 36"x36" | | W3-7 36"x36" | | W3-8 36"x36" | | W3-9 36"x36" | | W3-10 36"x36" |
| | RI-3P 18"x6" | | RI-4 18"x6" | | RI-5 18"x6" | | RI-6 18"x6" | | RI-7 18"x6" | | RI-8 18"x6" | | RI-9 18"x6" | | RI-10 18"x6" | | RI-11 18"x6" | | RI-12 18"x6" |
| | MI-6 24"x24" | | MI-7 24"x24" | | MI-8 24"x24" | | MI-9 24"x24" | | MI-10 24"x24" | | MI-11 24"x24" | | MI-12 24"x24" | | MI-13 24"x24" | | MI-14 24"x24" | | MI-15 24"x24" |
| | S4-3P 24"x8" | | S4-4 24"x8" | | S4-5 24"x8" | | S4-6 24"x8" | | S4-7 24"x8" | | S4-8 24"x8" | | S4-9 24"x8" | | S4-10 24"x8" | | S4-11 24"x8" | | S4-12 24"x8" |
| | W4-2P 24"x10" | | W4-3 24"x10" | | W4-4 24"x10" | | W4-5 24"x10" | | W4-6 24"x10" | | W4-7 24"x10" | | W4-8 24"x10" | | W4-9 24"x10" | | W4-10 24"x10" | | W4-11 24"x10" |
| | <p>MINIMUM DIMENSIONS SHOWN SUPPORT SECTION</p> <p>(U-CHANNEL) STANDARD SUPPORT ASSEMBLIES</p> <p>NOTE: LENGTH OF SIGN POSTS SHALL BE DETERMINED SO AS TO PROVIDE FOR MINIMUM VERTICAL CLEARANCES AS CALLED FOR IN THE SPECIFICATIONS PLUS A MINIMUM VERTICAL PENETRATION OF 30" IN THE SOIL.</p> | | | | | | | | | | | | | | | | | | |
| | <p>TYPE A</p> <p>MINIMUM WEIGHT TYPE A & B = 3 LBS./FT. TYPE C = 2 LBS./FT.</p> | | | | | | | | | | | | | | | | | | |
| | <p>TYPE B</p> | | | | | | | | | | | | | | | | | | |
| | <p>TYPE C</p> | | | | | | | | | | | | | | | | | | |
| <p>STANDARD HIGHWAY SIGNS</p> | | | | | | | | | | | | | | | | | | | |
| <p>ARKANSAS STATE HIGHWAY COMMISSION STANDARD HIGHWAY SIGNS AND SUPPORT ASSEMBLIES STANDARD DRAWING SHS-1</p> | | | | | | | | | | | | | | | | | | | |
| <p>DATE: 12-17-72 REVISION: 5536D</p> | | | | | | | | | | | | | | | | | | | |

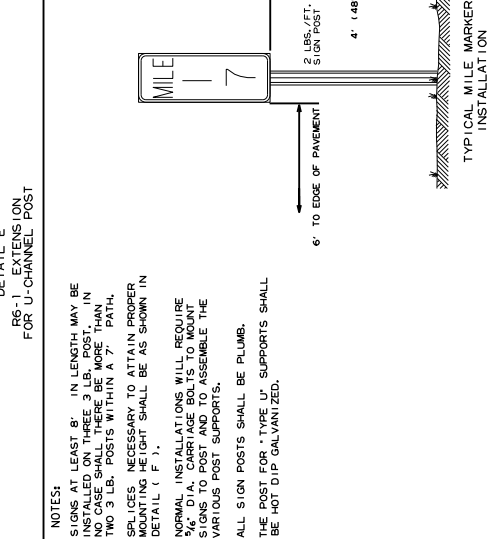
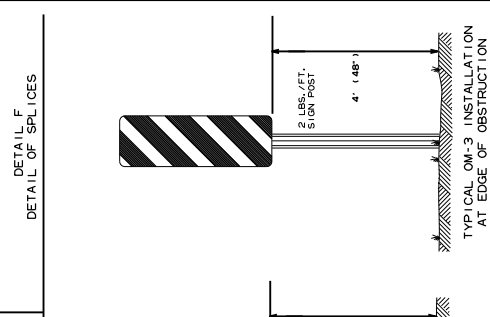
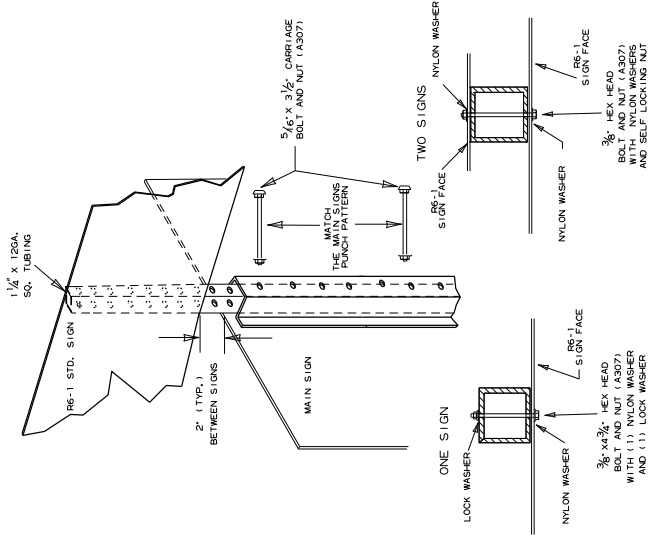
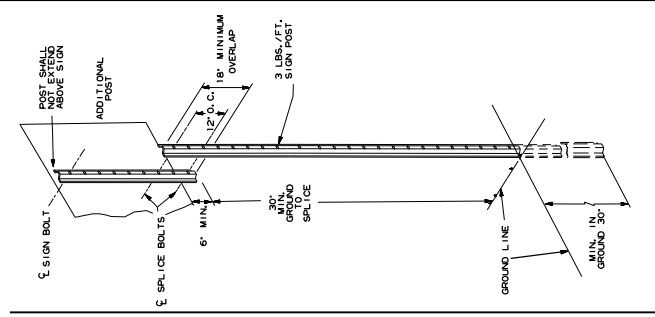

ARKANSAS STATE HIGHWAY COMMISSION
U-CHANNEL POST ASSEMBLIES

REVISION

| DATE | REVISION |
|---------|--|
| 7-25-19 | REVISED CARRIAGE BOLT WITH MATERIAL |
| 2-27-14 | REVISED NOTES. |
| 9-12-13 | REVISED U-2(1), U-2(6), U-3(1), U-3(2), U-3(3), U-3(4), U-3(5), U-3(6), U-3(7), U-3(8), U-3(9), U-3(10), U-3(11), U-3(12), U-3(13), U-3(14), U-3(15), U-3(16), U-3(17), U-3(18), U-3(19), U-3(20), U-3(21), U-3(22), U-3(23), U-3(24), U-3(25), U-3(26), U-3(27), U-3(28), U-3(29), U-3(30), U-3(31), U-3(32), U-3(33), U-3(34), U-3(35), U-3(36), U-3(37), U-3(38), U-3(39), U-3(40), U-3(41), U-3(42), U-3(43), U-3(44), U-3(45), U-3(46), U-3(47), U-3(48), U-3(49), U-3(50), U-3(51), U-3(52), U-3(53), U-3(54), U-3(55), U-3(56), U-3(57), U-3(58), U-3(59), U-3(60), U-3(61), U-3(62), U-3(63), U-3(64), U-3(65), U-3(66), U-3(67), U-3(68), U-3(69), U-3(70), U-3(71), U-3(72), U-3(73), U-3(74), U-3(75), U-3(76), U-3(77), U-3(78), U-3(79), U-3(80), U-3(81), U-3(82), U-3(83), U-3(84), U-3(85), U-3(86), U-3(87), U-3(88), U-3(89), U-3(90), U-3(91), U-3(92), U-3(93), U-3(94), U-3(95), U-3(96), U-3(97), U-3(98), U-3(99), U-3(100) |

DETAIL F
DETAIL OF SPLICES

DETAIL E
RS - EXTENSION FOR U-CHANNEL POST

NOTES:
SIGN POSTS AT LEAST 8' IN LENGTH MAY BE INSTALLED ON THREE 3 LB. POSTS. IN THIS CASE SIGN POSTS MUST BE PLUMB. TWO 3 LB. POSTS WITHIN 7' PATH. SPLICES NECESSARY TO ATTAIN PROPER PLUMB. SIGN POSTS SHALL BE AS SHOWN IN DETAIL (F).
NORMAL INSTALLATIONS WILL REQUIRE 2 1/2\"/>

ALL SIGN POSTS SHALL BE PLUMB.
THE POST FOR TYPE U' SUPPORTS SHALL BE HOT DIP GALVANIZED.

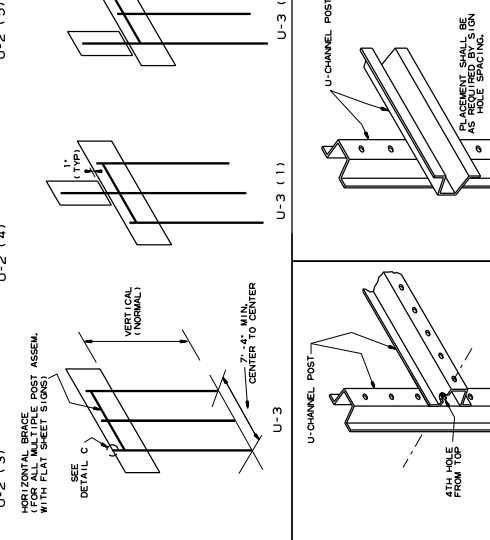
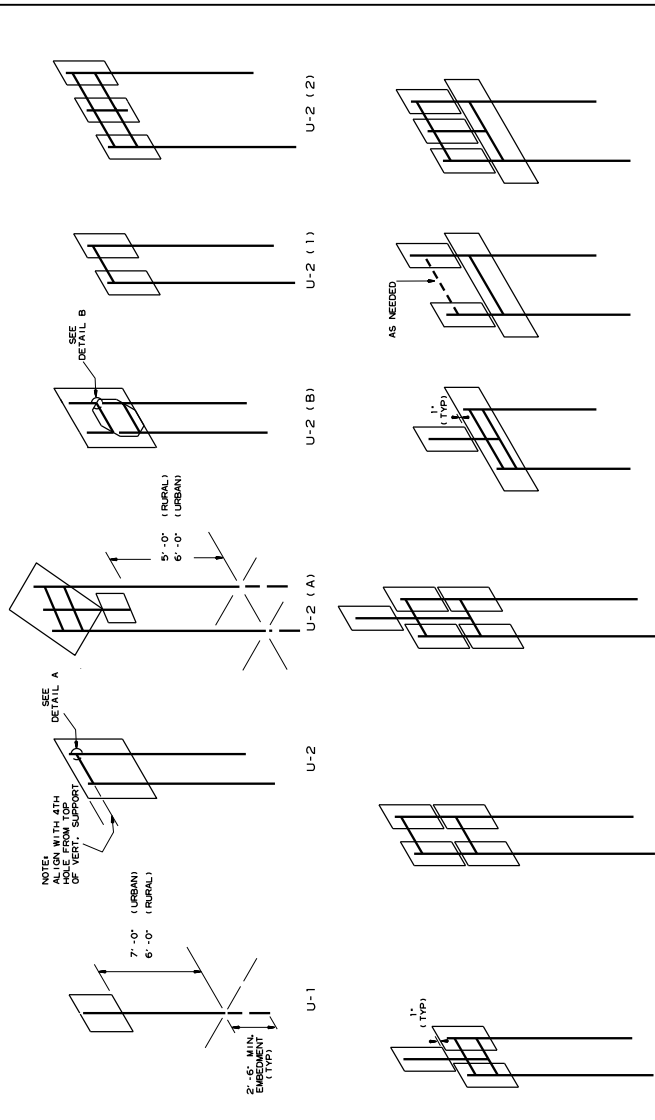

MINIMUM DIMENSIONS SHOWN

| | |
|---------|-----------|
| 1.50" | 3 LB./FT. |
| 1.42" | 2 LB./FT. |
| 1.25" | 3 LB./FT. |
| 1.25" | 2 LB./FT. |
| 1.25" | 3 LB./FT. |
| 1.25" | 2 LB./FT. |
| 3.125" | 3 LB./FT. |
| 3.1875" | 2 LB./FT. |

DETAIL C
U-CHANNEL POST

EXTRUDED PANEL
SIGN FACE
U-CHANNEL POST
POST CLIP

DETAIL C
SHOWING CLIP USED IN MOUNTING WITH EXTRUDED PANELS

U-CHANNEL POST
U-CHANNEL POST
U-CHANNEL POST
U-CHANNEL POST
U-CHANNEL POST
U-CHANNEL POST
U-CHANNEL POST
U-CHANNEL POST
U-CHANNEL POST
U-CHANNEL POST

DETAIL B
SHOWING BACK-TO-BACK INSTALLATION

DETAIL A
SHOWING HORIZONTAL BRACE

TRAFFIC CONTROL DEVICES

| VERTICAL DIFFERENTIAL | LOCATION | NON-INTERSTATE | TRAFFIC CONTROL |
|-----------------------|--|--|--|
| ≤ 1" | CENTRELINE | W-61T | W-61T |
| ≤ 1" | CENTRELINE | WB-11 AND CENTRELINE LANE STRIPING | WB-11 AND CENTRELINE LANE STRIPING |
| ≤ 3" | CENTRELINE | STANDARD LANE CLOSURE ⁽¹⁾ | STANDARD LANE CLOSURE ⁽¹⁾ |
| ≤ 3" | EDGE OF SHOULDER OR EDGE OF SHOULDER | WB-6 AND TRAFFIC DRUMS ⁽¹⁾ | WB-6 AND TRAFFIC DRUMS ⁽¹⁾ |
| > 3" | EDGE OF TRAVELLED LANE OR EDGE OF SHOULDER | WB-7, EDGE LINE STRIPING, AND TRAFFIC DRUMS ⁽¹⁾ | WB-7, EDGE LINE STRIPING, AND TRAFFIC DRUMS ⁽¹⁾ |
| > 6" | EDGE OF TRAVELLED LANE OR EDGE OF SHOULDER | WB-7, EDGE LINE STRIPING, AND TRAFFIC DRUMS ⁽¹⁾ | WB-7, EDGE LINE STRIPING, AND TRAFFIC DRUMS ⁽¹⁾ |
| > 18" | EDGE OF TRAVELLED LANE OR EDGE OF SHOULDER | WB-7, EDGE LINE STRIPING, AND TRAFFIC DRUMS ⁽¹⁾ | WB-7, EDGE LINE STRIPING, AND TRAFFIC DRUMS ⁽¹⁾ |
| > 24" | EDGE OF TRAVELLED LANE OR EDGE OF SHOULDER | PRECAST CONCRETE BARRIER ⁽¹⁾ & EDGE LINES | PRECAST CONCRETE BARRIER ⁽¹⁾ & EDGE LINES |

GENERAL NOTES: SHOULDER AREA IS USED AS PART OF THE TRAVELLED LANE AND THERE IS INSUFFICIENT WIDTH TO PLACE TRAFFIC DRUMS. TRAFFIC PANELS SHALL BE USED. TRAFFIC DRUMS ON THE REMAINING SHOULDER WITH A STABILIZED WEDGE SHALL BE USED. USED IN A LANE OF A STABILIZED WEDGE. WB-7 SIGN, EDGE LINE STRIPING, AND TRAFFIC DRUMS, A STABILIZED WEDGE, WB-7 SIGN, EDGE LINE STRIPING, AND TRAFFIC DRUMS CAN BE USED IF AND WHERE DIRECTED BY THE ENGINEER. R2-15, R2-15A, AND/OR R2-5B SIGNS SHALL BE USED IF AND WHERE DIRECTED BY THE ENGINEER. ALL TIME LIMITATIONS MUST CONFORM TO SECTION 603.02 OF THE STANDARD SPECIFICATIONS FOR HIGHWAY CONSTRUCTION (CURRENT EDITION).

| VERTICAL DIFFERENTIAL | LOCATION | INTERSTATE | TRAFFIC CONTROL |
|-----------------------|--|--|--|
| ≤ 3" | CENTRELINE | WB-11 AND LANE STRIPING | WB-11 AND LANE STRIPING |
| > 3" | EDGE OF TRAVELLED LANE OR EDGE OF SHOULDER | WB-7, EDGE LINE STRIPING, AND TRAFFIC DRUMS ⁽¹⁾ | WB-7, EDGE LINE STRIPING, AND TRAFFIC DRUMS ⁽¹⁾ |
| > 6" | EDGE OF TRAVELLED LANE OR EDGE OF SHOULDER | WB-7, EDGE LINE STRIPING, AND TRAFFIC DRUMS ⁽¹⁾ | WB-7, EDGE LINE STRIPING, AND TRAFFIC DRUMS ⁽¹⁾ |
| > 18" | EDGE OF TRAVELLED LANE OR EDGE OF SHOULDER | PRECAST CONCRETE BARRIER & EDGE LINES | PRECAST CONCRETE BARRIER & EDGE LINES |

| FORESLOPE | HEIGHT | TRAFFIC CONTROL |
|-----------|--------|--------------------------|
| 1:1 | > 3 FT | PRECAST CONCRETE BARRIER |
| 2:1 | > 3 FT | PRECAST CONCRETE BARRIER |
| FLAT | > 3 FT | TRAFFIC DRUMS |

CHANNELING DEVICES

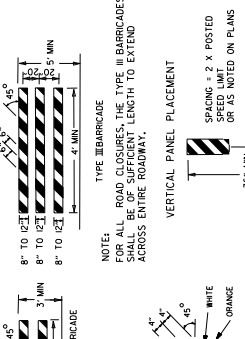
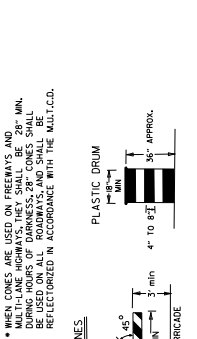

STABILIZED WEDGE

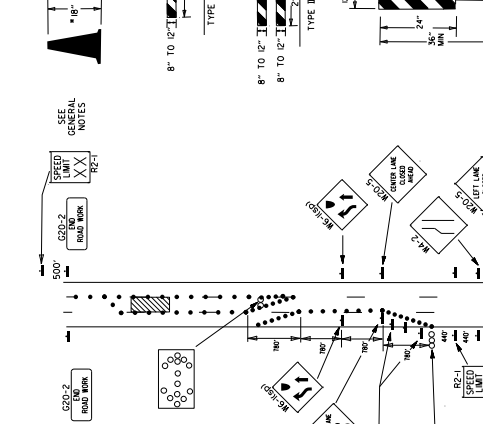
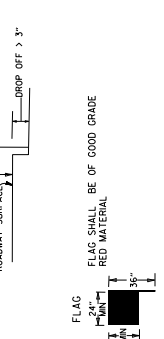

STABILIZED WEDGE

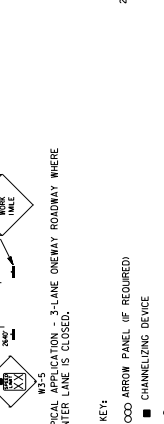

STABILIZED WEDGE

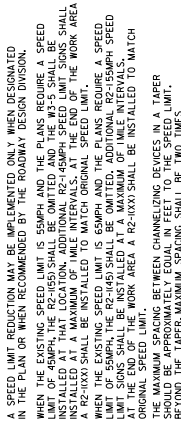

STABILIZED WEDGE

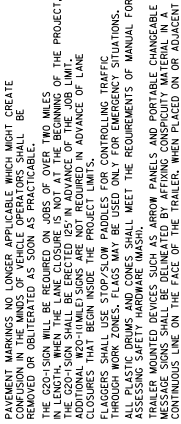

STABILIZED WEDGE

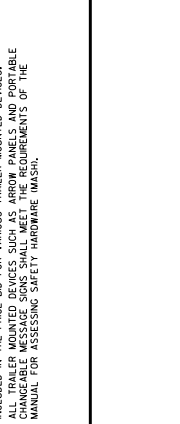

STABILIZED WEDGE

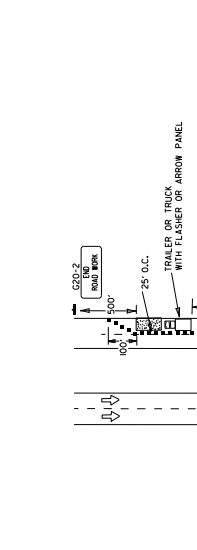

STABILIZED WEDGE

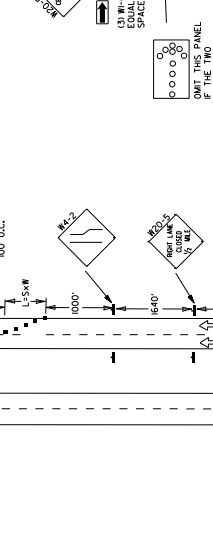

STABILIZED WEDGE

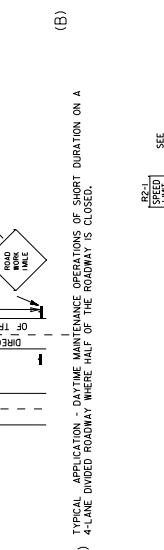

STABILIZED WEDGE

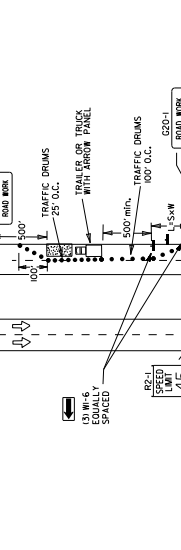

STABILIZED WEDGE

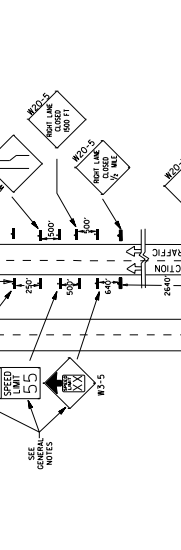

STABILIZED WEDGE

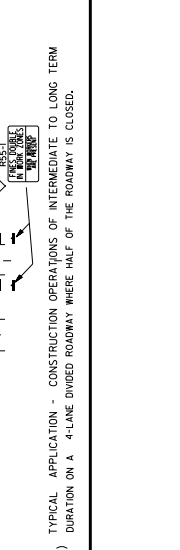

**ARKANSAS
STATE HIGHWAY COMMISSION**



**STANDARD SPECIFICATIONS
FOR
HIGHWAY CONSTRUCTION**

EDITION OF 2014

***PROPOSAL DOCUMENTS
AND
SCHEDULE OF ITEMS***

ARKANSAS STATE HIGHWAY COMMISSION

PROPOSAL DOCUMENTS

PROPOSAL FOR CONSTRUCTING:

THE PURPOSE OF THIS PROJECT IS TO OVERLAY APPROXIMATELY 1.97 MILES OF COUNTY ROAD 36 IN CLARK COUNTY. THIS PROJECT CONSISTS OF AGGREGATE BASE COURSE, ACHM SURFACE COURSE, ACHM PATCHING OF EXISTING ROADWAY, MAINTENANCE OF TRAFFIC, STANDARD SIGNS, PAVEMENT MARKING, AND MISC. ITEMS.

County Road No. CR 36 in **CLARK** County, Arkansas, in accordance with Standard Specifications for Highway Construction, Edition of 2014; the Supplemental Specifications and Special Provisions attached hereto; and the Construction Plans on file in the Office of the State Highway Commission, designated as

Job **SA1066** **STATE AID COUNTY JOB (CODE 9970)**

Job Name: **CO. RD. 36 OVERLAY (S)**

said project being approximately **1.97 miles in length.**

Proposal received until 1:30 p.m. on May 22, 2024

TO THE ARKANSAS STATE HIGHWAY COMMISSION:

Gentlemen: By submission of your bid, you agree to the following:

It is hereby certified that a careful examination has been made of the Plans, Specifications, Supplemental Specifications, Special Provisions, and Form of Contract and the site of the work throughout its whole extent. On the basis of the Plans, Specifications, Supplemental Specifications, Special Provisions, and Form of Contract, the bidder proposes to furnish all necessary machinery, equipment, tools, labor and other means of construction, and to furnish all materials as specified, in the manner and at the time prescribed, and to finish the entire project within the time hereinafter proposed. The bidder understands that the quantities of work mentioned herein are approximate only, and are subject to increase or decrease, and hereby proposes to perform all quantities of work, whether increased or decreased, in accordance with the provisions of the Specifications, and at the unit prices bid in the attached Schedule of Items.

Receipt is hereby specifically acknowledged, and complete examination expressly guaranteed of the following:

1. Standard Specifications for Highway Construction, Edition of 2014.
2. Supplemental Specifications.
3. Special Provisions.
4. Proposal Documents.
5. Schedule of Items.
6. Construction Plans.

The bidder further proposes to perform all Extra Work that may be required, on the basis provided in the Specifications, and to give such work personal attention, and to secure economical performance.

The bidder further proposes to execute the contract agreement, and to furnish satisfactory bonds within ten days after he has received notice that he has been awarded the contract. The bidder further agrees to begin work when ordered by the Engineer, or within ten days thereafter, and to complete the work **on or before November 22, 2024.**

PROPOSAL DOCUMENTS

(Continued)

The bidder also proposes to furnish a surety Performance bond or bonds in a sum equal to the full amount of the contract and a surety Payment bond or bonds in a sum equal to 80% of the full amount of the contract. These bonds shall not only serve to guarantee the completion of the work and payment of all bills and claims by the bidder, but also to guarantee the excellence of both workmanship and material until the work is finally accepted and the provisions of the Plans, Specifications and Special Provisions fulfilled.

The bidder shall furnish a Proposal Guaranty in the form specified in Subsection 102.09 of the Specifications, in the amount of five percent (5%) of the total amount bid, which is submitted as a guarantee of the good faith of the proposal, and that the Bidder will enter into written contract, as provided, to do the work should the award be made to him; and it is hereby agreed that if, at any time other than as provided in Subsection 102.11 of the Standard Specifications, Withdrawal/Modification of Proposals, the bidder should withdraw his proposal, or should fail to execute the contract and furnish satisfactory bonds as herein provided, if his proposal is accepted, the Arkansas State Highway Commission, in either of such events, shall be entitled and is hereby given the right to retain the Proposal Guaranty, not as a penalty, but as liquidated damages, it being understood and agreed by the bidder that the amount of the Proposal Guaranty is a reasonable sum to be fixed as liquidated damages considering the damages the Arkansas State Highway Commission will sustain in the event of the bidder's withdrawal of his proposal, or failure to execute the contract and furnish satisfactory bonds if his proposal is accepted, and said amount is herein agreed upon and fixed as liquidated damages because of the difficulty of ascertaining the exact amount of damage that may be sustained by reason of the above set out circumstances.

Arkansas Department of Transportation
Schedule of Items

State Job No.: SA1066
Job Name: CO. RD. 36 OVERLAY (S)
Federal Aid Project: 9970SA1066

Date Estimated: 3/18/2024
Date Revised:

| Line Number | Item Code and Description | Estimated Quantity | Unit Bid Price | Price Extension |
|------------------------------------|--|--------------------|-------------------|-----------------|
| Section 01 - PROPOSAL ITEMS | | | | |
| 0001 | SPSS303 - AGGREGATE BASE COURSE (CLASS 7) | 312.000 TON | | |
| 0002 | SS&401 - TACK COAT | 2,081.000 GAL | | |
| 0003 | SPSS407 - MINERAL AGGREGATE IN ACHM SURFACE COURSE (1/2") | 2,384.000 TON | | |
| 0004 | SPSS407 - ASPHALT BINDER (PG 64-22) IN ACHM SURFACE COURSE (1/2") (MINIMUM BID \$120.00) | 150.000 TON | | |
| 0005 | SPSS415 - ACHM PATCHING OF EXISTING ROADWAY | 50.000 TON | | |
| 0006 | SS&603 - MAINTENANCE OF TRAFFIC | 1.000 L.S. | | |
| 0007 | SS&604 - SIGNS | 178.000 SQFT | | |
| 0008 | 718 - REFLECTORIZED PAINT PAVEMENT MARKING YELLOW (4") | 17,162.000 LF | | |
| 0009 | 726 - STANDARD SIGN | 72.000 SQFT | | |
| 0010 | SS&729 - CHANNEL POST SIGN SUPPORT (TYPE C) | 16.000 EACH | | |
| | | | Section 01 Total: | _____ |
| | | | Subtotal: | _____ |
| 0011 | 601 - MOBILIZATION (UNIT BID AMOUNT MAY NOT EXCEED 5% OF SUBTOTAL) | 1.000 L.S. | | |
| | | | Bid Total: | _____ |

ARKANSAS DEPARTMENT OF TRANSPORTATION
SUPPLEMENT TO PROPOSAL
ANTI-COLLUSION AND DEBARMENT CERTIFICATION

**FAILURE TO EXECUTE AND SUBMIT THIS CERTIFICATION SHALL RENDER THIS
BID NONRESPONSIVE AND NOT ELIGIBLE FOR AWARD CONSIDERATION.**

As a condition precedent to the acceptance of the bidding document for this project, the bidder shall file this Affidavit executed by, or on behalf of the person, firm, association, or corporation submitting the bid. The original of this Affidavit shall be filed with the Arkansas Department of Transportation **at the time proposals are submitted.**

A F F I D A V I T

I hereby certify, under penalty of perjury under the laws of the United States and/or the State of Arkansas, that the bidder listed below has not, either directly or indirectly, entered into any agreement, participated in any collusion, or otherwise taken any action in restraint of free competitive bidding in connection with the submitted bid for this project, is not presently barred from bidding in any other jurisdiction as a result of any collusion or any other action in restraint of free competition, and that the foregoing is true and correct.

Further, that except as noted below, the bidder, or any person associated therewith in the capacity of owner, partner, director, officer, principal investigator, project director, manager, auditor, or any position involving the administration of Federal funds:

- a. is not currently under suspension, debarment, voluntary exclusion, or determination of ineligibility by any Federal, State, or Local agency;
- b. has not been suspended, debarred, voluntarily excluded or determined ineligible by any Federal, State, or Local agency within the past 3 years;
- c. does not have a proposed debarment pending; and
- d. has not been indicted, convicted, or had an adverse civil judgment rendered by a court of competent jurisdiction in any matter involving fraud or official misconduct within the past 3 years.

**ARKANSAS DEPARTMENT OF TRANSPORTATION
SUPPLEMENT TO PROPOSAL
ANTI-COLLUSION AND DEBARMENT CERTIFICATION**

**FAILURE TO EXECUTE AND SUBMIT THIS CERTIFICATION SHALL RENDER THIS
BID NONRESPONSIVE AND NOT ELIGIBLE FOR AWARD CONSIDERATION.**

EXCEPTIONS:

| APPLIED TO | INITIATING AGENCY | DATES OF ACTION |
|------------|-------------------|-----------------|
| _____ | _____ | _____ |
| _____ | _____ | _____ |
| _____ | _____ | _____ |

Exceptions will not necessarily result in denial of award, but will be considered in determining bidder responsibility. Providing false information may result in criminal prosecution or administrative sanctions.

| | |
|---|---|
| Job No. _____ F.A.P. No. _____ _____ (Date Executed) | _____ (Name of Bidder) _____ (Signature) _____ (Title of Person Signing) |
|---|---|

The following Notary Public certification is **OPTIONAL** and may or may not be completed at the contractor's discretion.

State of _____)
County of _____)ss.

_____, being duly sworn, deposes and says that he is

_____ of _____
(Title) (Name of Bidder)

and that the above statements are true and correct.

Subscribed and Sworn to before me this _____ day of _____, 20____.
My commission expires: _____.

(Notary Public)

ARKANSAS DEPARTMENT OF TRANSPORTATION
SUPPLEMENT TO PROPOSAL
RESTRICTION OF BOYCOTT OF ISRAEL CERTIFICATION

Pursuant to Arkansas Code Annotated § 25-1-503, a public entity **shall not** enter into a contract valued at \$1,000 or greater with a company unless the contract includes a written certification that the person or company is not currently engaged in, and agrees for the duration of the contract not to engage in, a boycott of Israel.

By signing below, the Contractor agrees and certifies that they do not boycott Israel and will not boycott Israel during the remaining aggregate term of the contract.

If a company does boycott Israel, see Arkansas Code Annotated § 25-1-503.

| | |
|-----------------------------------|--|
| Bid Number/Contract Number | |
| Description of product or service | |
| Contractor name | |

Contractor Signature: _____

Date: _____